

# JVC

Preliminary

# SERVICE MANUAL

DVD VIDEO RECORDER & VIDEO CASSETTE RECORDER

## DR-MV1SUC, DR-MV1SUS

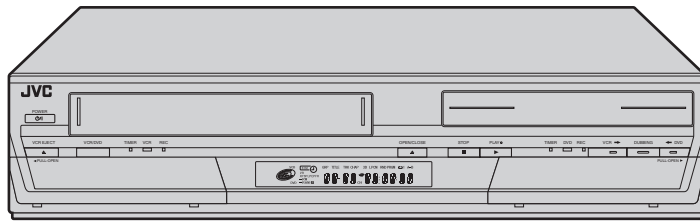

DR-MV1SUC, DR-MV1SUS [D3RV21]



For disassembling and assembling of MECHANISM ASSEMBLY, refer to the SERVICE MANUAL No.86700(MECHANISM ASSEMBLY).

### TABLE OF CONTENTS

1	PRECAUTION.....	1-3
2	SPECIFIC SERVICE INSTRUCTIONS.....	1-5
3	DISASSEMBLY.....	1-7
4	ADJUSTMENT.....	1-10
5	TROUBLESHOOTING.....	1-15

# SPECIFICATION

	DR-MV1SUC	DR-MV1SUS
<b>GENERAL</b>		
Power requirement	AC 120 V, 60 Hz	
Power consumption		
Power on	43 W	
Power off	16.5 W	
Temperature		
Operating	5°C to 35°C (41°F to 95°F)	
Storage	-20°C to 60°C (-4°F to 140°F)	
Operating position	Horizontal only	
Dimensions (W × H × D)	435 mm × 96 mm × 347 mm (17-3/16" × 3-13/16" × 13-11/16")	
Weight	6.1 kg (13.5 lbs)	
<b>VIDEO/AUDIO (DVD Deck)</b>		
Recording format	DVD-RAM: DVD Video Recording format DVD-R: DVD-Video format DVD-RW: DVD-Video format, DVD Video Recording format	
Recording time	Maximum 8 hours (with 4.7 GB disc) (XP): Approx. 1 hour, (SP): Approx. 2 hours, (LP): Approx. 4 hours (EP): Approx. 6 hours, (FR): Approx. 1 hour - 8 hours	
Audio recording system	Dolby Digital (2 ch), Linear PCM (XP mode only)	
Video recording compression system	MPEG2 (CBR/VBR)	
Input/Output		
S-video input	Y: 0.8 - 1.2 Vp-p, 75 Ω, C: 0.2 - 0.4 Vp-p, 75 Ω	
S-video output	Y: 1.0 Vp-p, 75 Ω, C: 0.3 Vp-p, 75 Ω	
Video input	0.5 - 2.0 Vp-p, 75 Ω (pin jack)	
Video output	1.0 Vp-p, 75 Ω (pin jack)	
Audio input	-8 dB, 50 kΩ (pin jack), Corresponding to mono (left)	
Audio output	-8 dB, 1 kΩ (pin jack)	
i.Link	4-pin for DV input	
Component video output	Y: 1.0 Vp-p, 75 Ω, CB/CR, PB/PR: 0.7 Vp-p, 75 Ω Corresponding to copy protection	
Digital audio output	Optical: -18 dBm, 660 nm, Coaxial: 0.7 Vp-p, 75 Ω, Corresponding to Dolby Digital and DTS Digital Surround Bit stream Selectable in digital audio output setting menu	
<b>VIDEO/AUDIO (VCR Deck)</b>		
Signal system	NTSC color signal and EIA monochrome signal, 525 lines/60 fields	
Recording system	DA4 (Double Azimuth) head helical scan system	
Format	VHS NTSC standard	
Maximum recording time		
(SP)	210 min. with ST-210 video cassette	
(EP)	630 min. with ST-210 video cassette	
Signal-to-noise ratio	45 dB	
Horizontal resolution	230 lines	
Frequency range	70 Hz to 10,000 Hz (Normal audio), 20 Hz to 20,000 Hz (Hi-Fi audio)	
Input/Output	RCA connectors: IN × 2, OUT × 1	
<b>TUNER/TIMER</b>		
Tuning system	Frequency synthesized tuner	
Channel coverage	VHF: Channels 2 - 13, UHF: Channels 14 - 69, CATV: 113 Channels	
RF output	Channel 3 or 4 (switchable; preset to Channel 3 when shipped) 75 Ω, unbalanced	
Memory backup time	Approx. 5 seconds	
<b>ACCESSORIES</b>		
Provided accessories	RF cable × 1, Infrared remote control unit, "AA" battery × 2	RF cable × 3, Antenna splitter, Infrared remote control unit, "AA" battery × 2

- Specifications shown are for SP mode unless otherwise specified.
- E. & O.E. Design and specifications subject to change without notice.
- VCR Plus+, C<sup>3</sup> and PlusCode are registered trademarks of Gemstar Development Corporation.
- The VCR Plus+ system is manufactured under license from Gemstar Development Corporation.
- DSS™ is an official trademark of DIRECTV, Inc., a unit of GM Hughes Electronics. DISH Network™ is a trademark of Echostar Communications Corporation.
- Manufactured under license from Dolby Laboratories. "Dolby" and the double-D symbol are trademarks of Dolby Laboratories.
- "DTS" and "DTS Digital Out" are trademarks of Digital Theater Systems, Inc.
- i.Link refers to the IEEE1394-1995 industry specification and extensions thereof. The i.Link logo is used for products compliant with the i.Link standard.

# SECTION 1 PRECAUTION

## 1.1 SAFTY PRECAUTIONS

Prior to shipment from the factory, JVC products are strictly inspected to conform with the recognized product safety and electrical codes of the countries in which they are to be sold. However, in order to maintain such compliance, it is equally important to implement the following precautions when a set is being serviced.

### 1.1.1 Precautions during Servicing

- (1) Locations requiring special caution are denoted by labels and inscriptions on the cabinet, chassis and certain parts of the product. When performing service, be sure to read and comply with these and other cautionary notices appearing in the operation and service manuals.
- (2) Parts identified by the  $\Delta$  symbol and shaded (■) parts are critical for safety.  
Replace only with specified part numbers.

#### NOTE :

**Parts in this category also include those specified to comply with X-ray emission standards for products using cathode ray tubes and those specified for compliance with various regulations regarding spurious radiation emission.**

- (3) Fuse replacement caution notice.  
Caution for continued protection against fire hazard.  
Replace only with same type and rated fuse(s) as specified.
- (4) Use specified internal wiring. Note especially:
  - Wires covered with PVC tubing
  - Double insulated wires
  - High voltage leads
- (5) Use specified insulating materials for hazardous live parts.  
Note especially:
  - Insulation Tape
  - PVC tubing
  - Spacers
  - Insulation sheets for transistors
  - Barrier
- (6) When replacing AC primary side components (transformers, power cords, noise blocking capacitors, etc.) wrap ends of wires securely about the terminals before soldering.

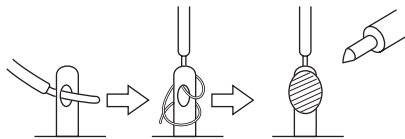

Fig. 1-1-1

- (7) Observe that wires do not contact heat producing parts (heatsinks, oxide metal film resistors, fusible resistors, etc.)
- (8) Check that replaced wires do not contact sharp edged or pointed parts.
- (9) When a power cord has been replaced, check that 10-15 kg of force in any direction will not loosen it.

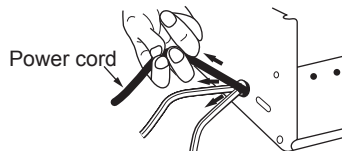

Fig. 1-1-2

- (10) Also check areas surrounding repaired locations.
- (11) Products using cathode ray tubes (CRTs) In regard to such products, the cathode ray tubes themselves, the high voltage circuits, and related circuits are specified for compliance with recognized codes pertaining to X-ray emission.

Consequently, when servicing these products, replace the cathode ray tubes and other parts with only the specified parts. Under no circumstances attempt to modify these circuits. Unauthorized modification can increase the high voltage value and cause X-ray emission from the cathode ray tube.

- (12) Crimp type wire connector In such cases as when replacing the power transformer in sets where the connections between the power cord and power transformer primary lead wires are performed using crimp type connectors, if replacing the connectors is unavoidable, in order to prevent safety hazards, perform carefully and precisely according to the following steps.

- **Connector part number** :E03830-001
- **Required tool** : Connector crimping tool of the proper type which will not damage insulated parts.
- **Replacement procedure**

- a) Remove the old connector by cutting the wires at a point close to the connector. Important : Do not reuse a connector (discard it).

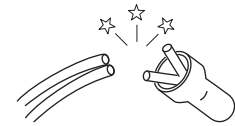

cut close to connector

Fig. 1-1-3

- b) Strip about 15 mm of the insulation from the ends of the wires. If the wires are stranded, twist the strands to avoid frayed conductors.

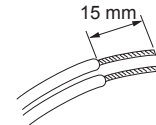

Fig. 1-1-4

- c) Align the lengths of the wires to be connected. Insert the wires fully into the connector.

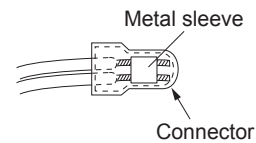

Fig. 1-1-5

- d) As shown in Fig. 1-1-6, use the crimping tool to crimp the metal sleeve at the center position. Be sure to crimp fully to the complete closure of the tool.

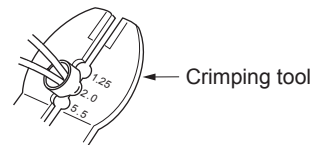

Fig. 1-1-6

- e) Check the four points noted in Fig. 1-1-7.

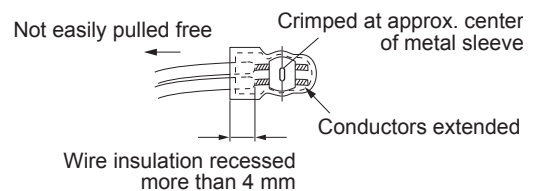

Fig. 1-1-7

### 1.1.2 Safety Check after Servicing

Examine the area surrounding the repaired location for damage or deterioration. Observe that screws, parts and wires have been returned to original positions. Afterwards, perform the following tests and confirm the specified values in order to verify compliance with safety standards.

#### (1) Insulation resistance test

Confirm the specified insulation resistance or greater between power cord plug prongs and externally exposed parts of the set (RF terminals, antenna terminals, video and audio input and output terminals, microphone jacks, earphone jacks, etc.). See table 1 below.

#### (2) Dielectric strength test

Confirm specified dielectric strength or greater between power cord plug prongs and exposed accessible parts of the set (RF terminals, antenna terminals, video and audio input and output terminals, microphone jacks, earphone jacks, etc.). See Fig.1-1-11 below.

#### (3) Clearance distance

When replacing primary circuit components, confirm specified clearance distance (d), (d') between soldered terminals, and between terminals and surrounding metallic parts. See Fig.1-1-11 below.

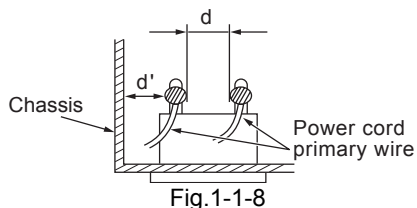

Fig.1-1-8

#### (4) Leakage current test

Confirm specified or lower leakage current between earth ground/power cord plug prongs and externally exposed accessible parts (RF terminals, antenna terminals, video and audio input and output terminals, microphone jacks, earphone jacks, etc.).

Measuring Method : (Power ON) Insert load Z between earth ground/power cord plug prongs and externally exposed accessible parts. Use an AC voltmeter to measure across both terminals of load Z. See Fig.1-1-9 and following Fig.1-1-12.

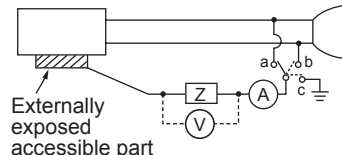
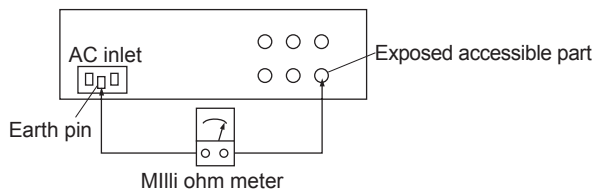

Fig.1-1-9

#### (5) Grounding (Class 1 model only)

Confirm specified or lower grounding impedance between earth pin in AC inlet and externally exposed accessible parts (Video in, Video out, Audio in, Audio out or Fixing screw etc.). Measuring Method:

Connect milli ohm meter between earth pin in AC inlet and exposed accessible parts. See Fig.1-1-10 and grounding specifications.



#### Grounding Specifications

Region	Grounding Impedance (Z)
USA & Canada	$Z \leq 0.1 \text{ ohm}$
Europe & Australia	$Z \leq 0.5 \text{ ohm}$

Fig.1-1-10

AC Line Voltage	Region	Insulation Resistance (R)	Dielectric Strength	Clearance Distance (d), (d')
100 V	Japan	$R \geq 1 \text{ M}\Omega/500 \text{ V DC}$	AC 1 kV 1 minute	$d, d' \geq 3 \text{ mm}$
100 to 240 V			AC 1.5 kV 1 minute	$d, d' \geq 4 \text{ mm}$
110 to 130 V	USA & Canada	$1 \text{ M}\Omega \leq R \leq 12 \text{ M}\Omega/500 \text{ V DC}$	AC 1 kV 1 minute	$d, d' \geq 3.2 \text{ mm}$
110 to 130 V 200 to 240 V	Europe & Australia	$R \geq 10 \text{ M}\Omega/500 \text{ V DC}$	AC 3 kV 1 minute (Class II) AC 1.5 kV 1 minute (Class I)	$d \geq 4 \text{ mm}$ $d' \geq 8 \text{ mm}$ (Power cord) $d' \geq 6 \text{ mm}$ (Primary wire)

Fig.1-1-11

AC Line Voltage	Region	Load Z	Leakage Current (i)	a, b, c
100 V	Japan	$1 \text{ k}\Omega$	$i \leq 1 \text{ mA rms}$	Exposed accessible parts
110 to 130 V	USA & Canada	$0.15 \mu\text{F}$ and $1.5 \text{ k}\Omega$	$i \leq 0.5 \text{ mA rms}$	Exposed accessible parts
110 to 130 V 220 to 240 V	Europe & Australia	$2 \text{ k}\Omega$	$i \leq 0.7 \text{ mA peak}$ $i \leq 2 \text{ mA dc}$	Antenna earth terminals
		$50 \text{ k}\Omega$	$i \leq 0.7 \text{ mA peak}$ $i \leq 2 \text{ mA dc}$	Other terminals

Fig.1-1-12

#### NOTE :

These tables are unofficial and for reference only. Be sure to confirm the precise values for your particular country and locality.

## SECTION 2

# SPECIFIC SERVICE INSTRUCTIONS

### 2.1 Service position

This unit has been designed so that the Mechanism and Main board assemblies can be removed together from the bottom chassis. Before diagnosing or servicing the circuit boards, take out the major parts from the bottom chassis.

#### 2.1.1 How to set the "Service position"

- (1) Refer to the disassembly procedure and perform the disassembly of the major parts before removing the Mechanism assembly.
- (2) Remove the screws that fix the Mechanism, Main board assembly to the bottom chassis. If any other screws are used to fix the boards, remove them also.
- (3) Remove the combined Mechanism, DVD unit, regulator, digital, junction and Main board assemblies.
- (4) If any other major parts are used, remove them also.
- (5) Connect the wires and connectors of the major parts that have been removed in steps (1) to (4). (Refer to Fig. 2-1a.)
- (6) Place the combined Mechanism, Main board and other board assemblies upside down.
- (7) Insert the power cord plug into the power outlet and then proceed with the diagnostics and servicing of the board assembly.

#### Notes:

- Before inserting the power cord plug into the power outlet, make sure that none of the electrical parts are able to short-circuit between the workbench and the board assembly.
- For the disassembly procedure of the major parts and details of the precautions to be taken, see "Removing the major parts".
- If there are wire connections from the Main board and Mechanism assemblies to the other major parts, be sure to remove them (including wires connected to the major parts) first before performing step (2).
- When carrying out diagnosis and repair of the Main board assembly in the "Service position", be sure to ground both the Main board and Mechanism assemblies. If they are improperly grounded, there may be noise on the playback picture or FDP counter display may move even when the mechanism is kept in an inoperative status.
- In order to diagnose the playback or recording of the cassette tape, set the Mechanism assembly to the required mode before placing it upside down. If the mechanism mode is changed (including ejection) while it is in an upside down position the tape inside may be damaged.
- For some models, the mechanism and board assemblies are attached by connectors only. When carrying out a diagnosis or repair of the boards in the "Service position", make sure that the connectors are not disconnected.

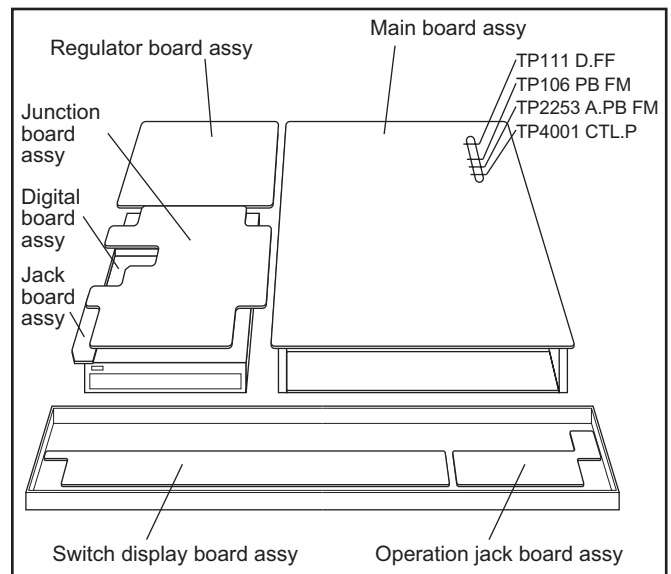

Fig.2-1a

### 2.2 Jig RCU mode

This unit uses the following two modes for receiving remote control codes.

- (1) User RCU mode: Ordinary mode for use by the user.
- (2) Jig RCU mode: Mode for use in production and servicing.

When using the Jig RCU, it is required to set the VCR to the Jig RCU mode (the mode in which codes from the Jig RCU can be received). As both of the above two modes are stored in the EEPROM, it is required to set the VCR back to the User RCU mode each time that an adjustment is made or to check that the necessary operations have been completed. These modes can be set by the operations described below.

#### Note:

- When the unit is set to JIG mode and when the unit is under JIG mode, the remote control unit attached to product operates only in "Remote Control Code 1". Since the unit is in "Remote Control Code 3" when it is shipped and just after its batteries are changed, "Remote Control Code 3" needs to be changed to "Remote Control Code 1."
- Confirm the RCU mode when exchanged parts. Since some SERVICE PARTS sets the VCR to the Jig RCU mode as initial setting. Therefore please set the VCR to the user RCU mode after replacing the EEPROM.

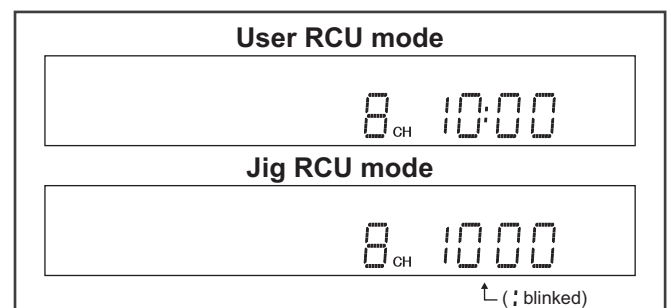

Fig.2-2a User/Jig RCU mode

### 2.2.1 Changing Remote Control Code

- (1) Slide the TV/CABLE/DBS/DVD switch to DVD.
- (2) Press the numeric button "1" of the remote control unit while pressing the "SET UP" button of the remote control unit. Then, press the "ENTER" button, and then release the "SET UP" button.
- (3) Press the "POWER" button on the unit to turn off the unit.
- (4) Press the "PLAY" button on the unit for over 5 seconds while the unit is turned off. The code currently set appears on the front display panel.
- (5) Press the "STOP" button on the remote control to change the unit's code. When FDP indicator displays "DVD1," it means that the Remote Control Code has been changed to "1."

### 2.2.2 Setting the Jig RCU mode

- (1) Turn on the power.
- (2) Press the "VCR/DVD" button repeatedly on the unit so that the VCR lamp lights up on the unit.
- (3) Press the following remoon keys continuously within 2 seconds " SET UP " → " 2 " → " 8 " → " ENTER ".  
When the VCR is set to the Jig RCU mode, the symbols ( " : " ) in the time display of the FDP are blinked.  
(Refer to Fig.2-2a User/Jig RCU mode)

### 2.2.3 Setting the User RCU mode

- (1) Turn off the power.
- (2) Press the "REC" and "PAUSE" buttons of the VCR simultaneously. Alternatively, transmit the code "9D" from the Jig RCU.

### 2.3 Mechanism service mode

This model has a unique function to enter the mechanism into every operation mode without loading of any cassette tape. This function is called the "Mechanism service mode".

#### 2.3.1 How to set the "Mechanism service mode"

- (1) Set the VCR to the Jig RCU mode (the mode in which codes from the Jig RCU can be received)
- (2) Transmit the code "E5" from the Jig RCU.
- (3) Release the lug of the Cassette holder and then slide the Cassette holder toward the direction where the Cassette holder is loaded by manually.
- (4) The cassette holder lowers and, when the loading has completed, the mechanism enters the desired mode.  
When the VCR is set to the Mechanism service mode, the symbols ("HDD") in the FDP (LED) are turned on.

#### 2.3.2 How to exit from the "Mechanism service mode"

- (1) Unplug the power cord plug from the power outlet.

### 2.4 Maintenance and inspection

#### 2.4.1 Cleaning

Regular cleaning of the transport system parts is desirable but practically impossible. So make it a rule to carry out cleaning of the tape transport system whenever the machine is serviced. When the video head, tape guide and/or brush get soiled, the playback picture may appear inferior or at worst disappear, resulting in possible tape damage.

#### Note:

- **Absolutely avoid sweeping the upper drum vertically as this will cause damage to the video head.**
- (1) When cleaning the upper drum (especially the video head), soak a piece of closely woven cloth with alcohol and while holding the cloth onto the upper drum by the fingers, turn the upper drum counterclockwise.

- (2) To clean the parts of the tape transport system other than the upper drum, use a piece of closely woven cloth or a cotton swab soaked with alcohol.
- (3) After cleaning, make sure that the cleaned parts are completely dry before using the cassette tape.

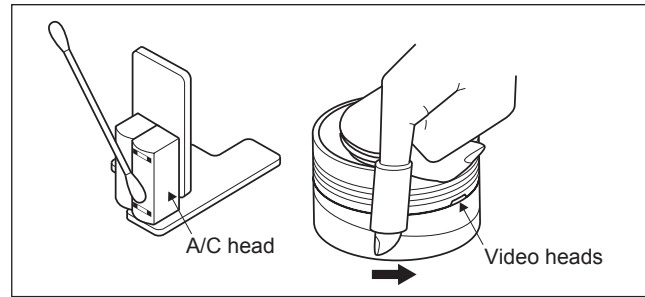

Fig.2-4a

#### 2.4.2 Lubrication

With no need for periodical lubrication, you have only to lubricate new parts after replacement. If any oil or grease on contact parts is soiled, wipe it off and newly lubricate the parts.

#### Note:

- See the "mechanism assembly" diagram of the "parts list" for the lubricating or greasing spots, and for the types of oil or grease to be used.

#### 2.4.3 Suggested servicing schedule for main components

The following table indicates the suggested period for such service measures as cleaning, lubrication and replacement. In practice, the indicated periods will vary widely according to environmental and usage conditions. However, the indicated components should be inspected when a set is brought for service and the maintenance work performed if necessary. Also note that rubber parts may deform in time, even if the set is not used.

System	Parts name	Operation hours	
		1000H	2000H
Tape transport	Drum assembly	C,X	X
	A/C head	C,X	C,X
	Pinch roller arm assembly	C	C
	Full erase head	C	C
	Tension arm assembly	C	C
	Capstan motor (Shaft)	C	C
	Guide arm assembly	C	C
Drive	Capstan motor		X
	Capstan brake assembly		X
	Main brake assembly		X
	Belt (Capstan)	X	X
	Loading motor		X
	Clutch unit		X
	Worm gear		X
Other	Control plate		X
	Rotary encoder		X

C : Cleaning

X : Inspection or Replacement if necessary

# SECTION 3 DISASSEMBLY

## 3.1 Removing the major parts

### 3.1.1 Destination of connectors

Two kinds of double-arrows in connection tables respectively show kinds of connector/wires.

⇔ : Flat wire ↔ : Wire ↔ : Board to board (B-B)

■ : The connector of the side to remove

CONN. No.	CONNECTOR				PIN No.	
WR2a	Main	CN101	⇔	Digital	CN761	40
WR2b	Main	CN103	⇔	Digital	CN762	10

### Destination of connectors

CONN. No.	CONNECTOR				PIN No.	
WR2a	Main	CN3104	⇔	Operation jack	CN7201	13
WR2b	Main	CN3102	⇔	Switch display	CN7001	11
WR2c	Junction	CN7103	⇔	Switch display	CN7002	4
WR3a	Main	CN2001	⇔	A/C head		6
WR3b	Drum assembly		⇔	Main	CN1	9
WR4a	DVD unit		⇔	Digital	CN2201	40
WR4b	DVD unit		⇔	Regulator	CN5303	4
WR5a	Junction	CN7106	⇔	Digital	CN1404	4
CN7108 (CN1001)	Junction	CN7108	↔	Digital	CN1001	28
CN7109 (CN1002)	Junction	CN7109	↔	Digital	CN1002	28
CN4104 (CN1801)	Jack	CN4104	↔	Digital	CN1801	10
WR7a	Junction	CN7104	⇔	Main	CN501	4
WR7b	Main	CN3103	↔	Junction	CN7102	15
WR7c	Main	CN2601	↔	Junction	CN8001	11
WR7d	Junction	CN7107	⇔	Main	CN7111	13
WR7e	Regulator	CN5304	↔	Junction	CN5501	15
WR8a	Regulator	CN5301	↔	Main	CN5311	15
WR8b	Regulator	CN5302	↔	Fun motor		2

### 3.1.2 How to read the procedure table

This table shows the steps for disassembly of the externally furnished parts and board assemblies. Reverse these steps when re-assembling them.

Step/LocNo.	Part Name	Fig. No.	Point	Note
[1]	Top cover	3-1a	4(S1a),(S1b),3(L1a), 2(SD1a),(P1a),(W1a), CN1(WR1a),	<Note 1a>
	Bracket		2(S1c)	

(1) (2) (3) (4) (5)

#### (1) Order of steps in Procedure

When reassembling, perform the step(s) in the reverse order.

These numbers are also used as the identification (location) No. of parts Figures.

#### (2) Part name to be removed or installed.

#### (3) Fig. No. showing procedure or part location.

#### (4) Identification of part to be removed, unhooked, unlocked, released, unplugged, unclamped or unsoldered.

P= Spring, W= Washer, S= Screw, L= Locking tab, SD= Solder, CN\*\*(WR\*\*)= Remove the wire (WR\*\*) from the connector (CN\*\*).

#### Note:

- The bracketed ( ) WR of the connector symbol are assigned nos. in priority order and do not correspond to those on the spare parts list.

(5) Adjustment information for installation

### 3.1.3 Disassembly procedure

Step/LocNo.	Part Name	Fig. No.	Point	Note
[1]	Top cover	3-1d	6(S1a)	
[2]	Front panel assembly (Operation jack board assembly) (Switch display board assembly)	3-1a, 3-1d	3(L2a),5(L2b) CN3104(WR2a) CN3102(WR2b) CN7103(WR2c)	<Note2a> <Note2b>
[3]	Mechanism assembly (Drum assembly) (Cleaner assembly)	3-1b, 3-1c, 3-1d	CN2001(WR3a) 3(S3a),(S3b) CN(WR3b) (S3c),(S3d),(S3e) 2(L3a)	<Note2a> <Note3a> <Note3b> <Note3c>
[4]	DVD unit (Bracket)	3-1d	4(S4a),4(S4b) (WR4a),(WR4b)	<Note2a>
[5]	Digital board assembly	3-1d	4(S5a) CN7106(WR5a),CN7101 (CN1001),CN7109(CN1002)	<Note2a>
[6]	Jack board assembly	3-1d	(S6a),CN4104(CN1801)	
[7]	Junction board assembly	3-1d	(S7a),CN7104(WR7a), CN3103(WR7b),CN2601 (WR7c),CN7107(WR7d), CN5304(WR7e)	<Note2a>
[8]	Regulator board assembly	3-1d	4(S8a) CN5301(WR8a), CN5302(WR8b)	<Note2a>
[9]	Rear cover	3-1d	2(S9a),5(S9b),2(S9c),3(L9a)	
[10]	Main board assembly	3-1d	3(S10a)	

#### <Note 2a>

- Be careful not to damage the connector and wire etc. during connection and disconnection.
- When connecting the flat wire to the connector, be careful with the flat wire direction.

#### <Note 2b>

- When reattaching the Front panel assembly, make sure that the door opener of the Side frame (R) is lowered in position prior to the reinstallation.
- When reattaching the Front panel assembly, pay careful attention to the switch lever of the Front panel assembly not to make it touch the switch knob of the Main board assembly from the side.
- When reattaching the Front panel assembly, lift the Cassette door slightly.

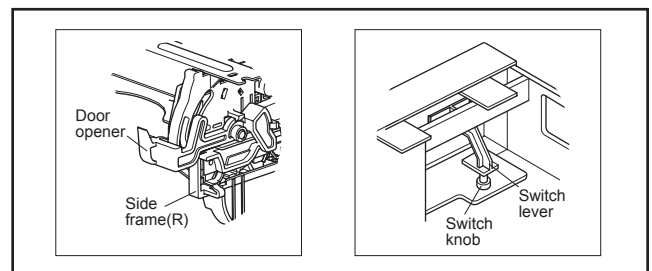

Fig.3-1a

**<Note 3a>**

- When reattaching the Mechanism assembly, secure the screws (S3a to S3b) in the order of 1,2,3.

**<Note 3b>**

- When reattaching the Mechanism assembly, be sure to align the phase of the Rotary encoder on the Main board assembly.
- When reattaching the Mechanism assembly, set the "Mechanism assembling mode". [See "MECHANISM ASSEMBLY SERVICE MANUAL (No. 86700)".]
- When reattaching the Mechanism assembly to the Main board assembly, take care not to damage the sensors and switch on the Main board assembly.

**<Note 3c>**

- When reattaching the Drum assembly, secure the screws (S3c to S3e) in the order of c, d, e.

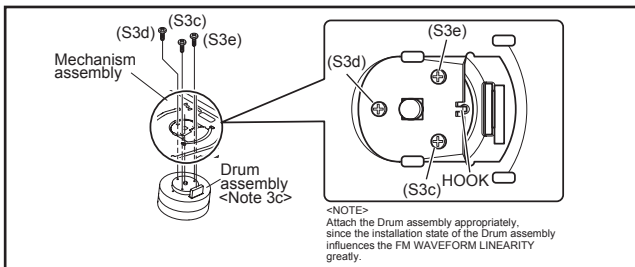

Fig.3-1b

- When handling the drum assembly alone, hold it by the motor or shaft. Be careful not to touch other parts, especially the video heads. Also take care not to damage the connectors.

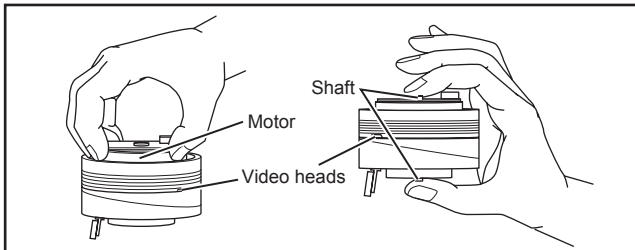

Fig.3-1c



NOTE

1.Insert direction of FCC WIRE as follows.



2.FFC WIRE and DRUM FPC WIRE should be insert as follows.



3.Insert the wire to even the root of connector completely at the same time as inserting each wire.

4.Check to see that outside parts.TOP COVER.BOTTOM COVER.FRONT PANEL, etc are fixed certainly to the BOTTOM CHASSIS with SCREWS.

5.Pay attention NOT to make any scratches on FRONT PANEL.

6.Pay close attention not to cut any Sheath of WIRE by sharp edge of CHASSIS while Wiring Process.

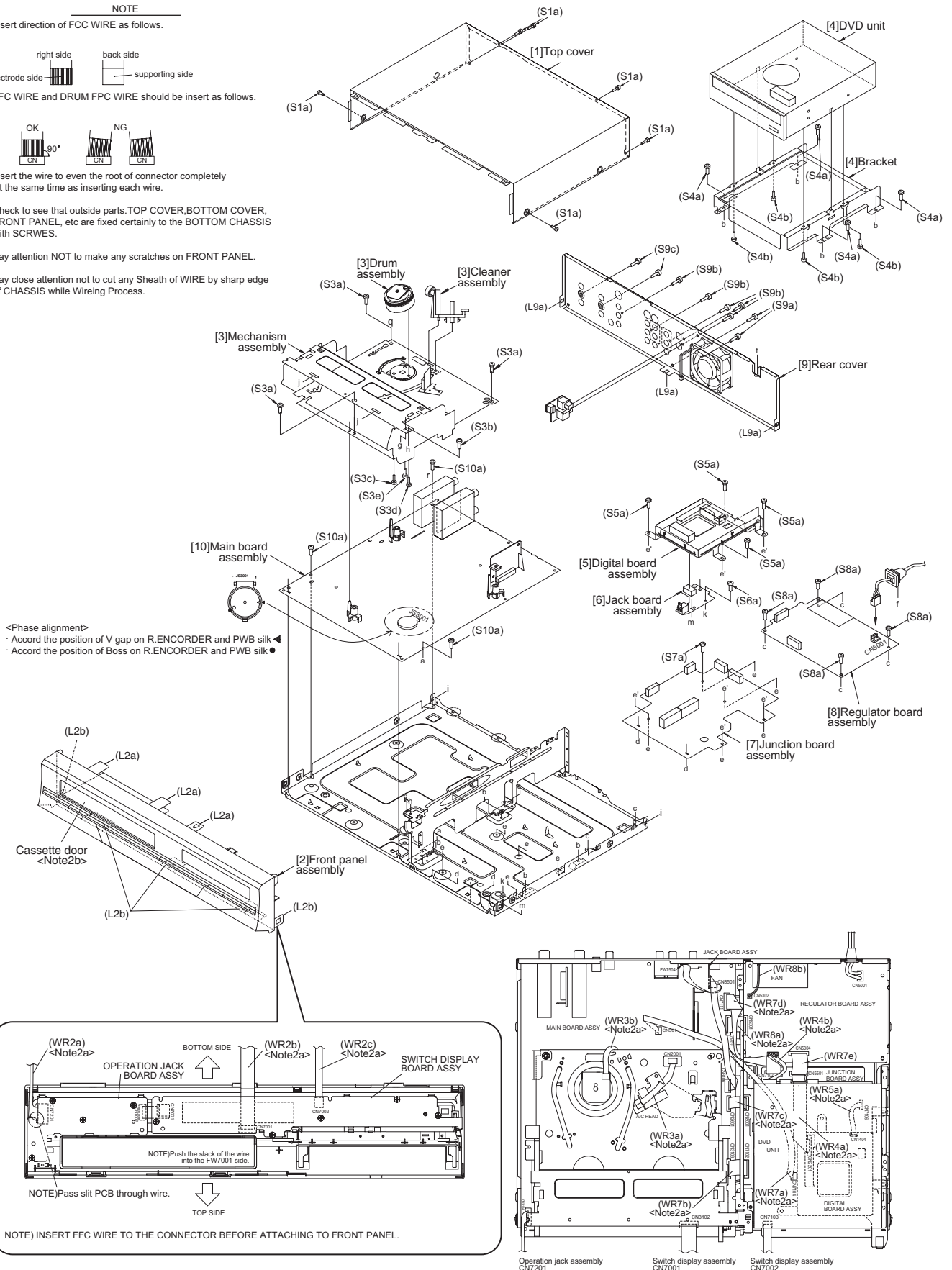

<Phase alignment>  
 \* Accord the position of V gap on R.ENCORDER and PWB silk  
 \* Accord the position of Boss on R.ENCORDER and PWB silk

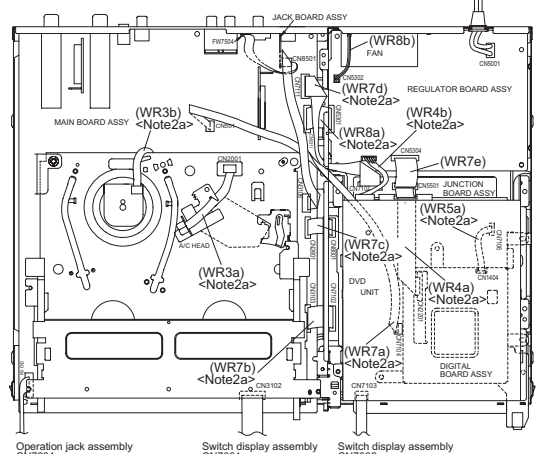
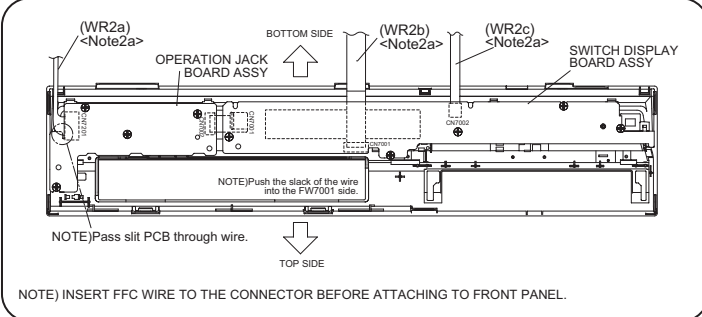

Fig.3-1d

# SECTION 4 ADJUSTMENT

## 4.1 Before adjustment

### 4.1.1 Precaution

- The adjustments of this unit include the mechanism compatibility and electrical adjustments. During the performance of this work, be sure to observe the precautions for each type of adjustment.
- If there is a reference to a signal input method in the signal column of the adjustment chart, "Ext. S-input" means the Y/C separated video signal and "Ext. input" means the composite video signal input.
- Unless otherwise specified, all measuring points and adjustment parts are located on the Main board.

### 4.1.2 Required test equipments

- Color (colour) television or monitor
- Oscilloscope: wide-band, dual-trace, triggered delayed sweep
- Signal generator: RF / IF sweep / marker
- Signal generator: stairstep, color (colour) bar [NTSC]
- Recording tape
- Digit-key remote controller(provided)

### 4.1.3 Required adjustment tools

● : Used --- : Not used

	Mechanism compatibility adjustment	Electrical adjustment
Roller driver	●	---
Jig RCU	---	●
Back tension cassette gauge	●	---
Alignment tape(MHP)	●	---
Alignment tape(MHP-L)	●	●

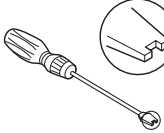
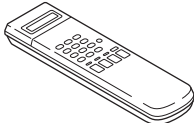
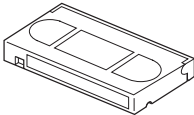
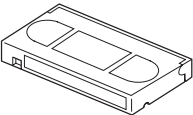
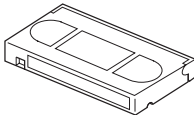
Roller driver PTU94002	Jig RCU PTU94023B	Back tension cassette gauge PUJ48076-2
		
Alignment tape (SP, stairstep, NTSC) MHP	Alignment tape (EP, stairstep, NTSC) MHP-L	
		

### 4.1.4 Color (colour) bar signal, Color (colour) bar pattern

- Color(colour) bar signal [NTSC] • Color(colour) bar pattern [NTSC]

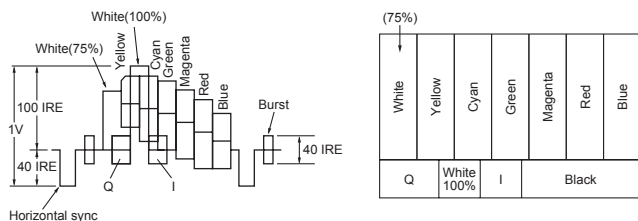

### 4.1.5 Switch settings

When adjusting this unit, set the VCR mode and switches as described below.

- When using the Jig RCU, it is required to set the VCR to the Jig RCU mode (the mode in which codes from the Jig RCU can be received). (See "section 2 SPECIFIC SERVICE INSTRUCTIONS".)

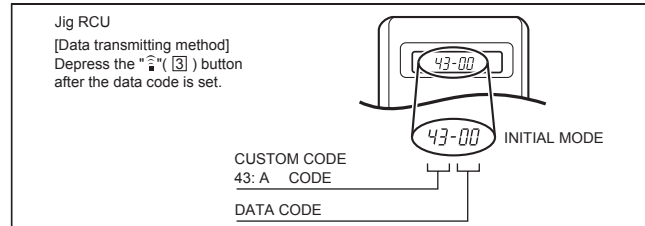

Fig.4-1 Jig RCU [PTU94023B]

- Set the switches as shown below unless otherwise specified on the relevant adjustment chart. The switches that are not listed below can be set as desired.

If the VCR is not equipped with the functions detailed below, setup is not required.

AUTO PICTURE/VIDEO CALIBRATION/ B.E.S.T./D.S.P.C.	OFF
PICTURE CONTROL/SMART PICTURE	NORMAL/NATURAL
VIDEO STABILIZER	OFF
TBC	ON
Digital 3R	ON
VIDEO NAVIGATION/TAPE MANAGER	OFF
BLUE BACK	OFF

### 4.1.6 Manual tracking mode (Auto tracking ON/OFF) setting

- (1) In order to set to the manual tracking mode during tape playback, press the "SP/EP(LP)" button on the remote control unit.

- Each press of the button switches the auto tracking ON or OFF.
- When the manual tracking mode is set, the tracking is placed at the center position.

- (2) Press "channel +/-" to adjust the tracking manually.

### 4.1.7 EVR Adjustment

Some of the electrical adjustments require the adjustment performed by the EVR system. The main unit have EEPROMs for storing the EVR adjustment data and user setups.

#### Notes:

- In the EVR adjustment mode, the value is varied with the channel buttons (+, -). The adjusted data is stored when the setting mode changes (from PB to STOP, when the tape speed is changed, etc.). Take care to identify the current mode of each adjustment item when making an adjustment.

- When changing the address setting in the EVR adjustment mode, use the Jig RCU or the remote controller having numeric keypad with which a numeric code can be directly input.

The remote control code of the Jig RCU corresponds to each of the digit keys on the remote controller as follows.

Digit-key	0	1	2	3	4	5	6	7	8	9
Code	20	21	22	23	24	25	26	27	28	29

- As the counter indication and remaining tape indication are not displayed FDP during the EVR adjustment mode, check them on the TV monitor screen.
- When performing the EVR adjustment, confirm that the FDP indication is changed to the EVR mode.

#### 4.2 Mechanism compatibility adjustment (VHS SECTION)

##### Notes:

- Although compatibility adjustment is very important, it is not necessary to perform this as part of the normal servicing work. It will be required when you have replaced the A/C head, drum assembly or any part of the tape transport system.
- To prevent damaging the alignment tape in the compatibility adjustment, prepare a cassette tape (for self-recording/playback), perform a test on it by transporting it and making sure that the tape is not bent by the tape transport mechanisms such as in the guide rollers.(See Fig.4-2b.)

##### 4.2.1 Tension pole position

##### Notes:

- This adjustment must be performed every time the tension band is replaced.

Signal	(A)	• Back tension cassette gauge [PUJ48076-2]
Mode	(B1) (B2)	• PB • Eject end
Adjustment part	(F)	• Adjust pin [Mechansim assembly]
Specified value	(G)	• 25 - 51 gf•cm (2.45 - 5 x 10 <sup>-3</sup> Nm)

- (1) Play back the back tension cassette gauge (A).
- (2) Check that the indicated value on the left side gauge is within the specified value (G).
- (3) If the indicated value is not within the specified value (G), perform the adjustment in a following procedure.(See Fig.4-2a.)
  - a) Remove the top frame, cassette holder and side frames (L/R) all together. (Refer to the SERVICE MANUAL No.86700 [MECHANISM ASSEMBLY].)
  - b) Rotate the loading motor gear to move the control plate so that the triangular stamping to the left of the "P" stamping is aligned with the stamping (a) on the main deck. This positioning is mode (B1).
  - c) Adjust by turning the adjustment pin so that the tip of the tension arm is aligned with the stamping (b) on the main deck.
  - d) Rotate the reel disk (S) by about one turn clockwise and make sure that the round hole of the adjustment pin is located in the "OK" range. If it is outside this range, restart the adjustment from the beginning.

After completion of the adjustment, rotate the loading gear motor to return it to the mode (B2) position.

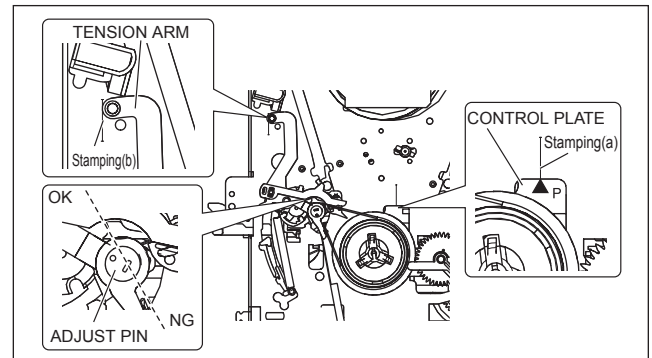

Fig.4-2a

##### 4.2.2 FM waveform linearity

Signal	(A1) (A2)	• Alignment tape(SP, stairstep, NTSC) [MHP] • Alignment tape(EP, stairstep, NTSC) [MHP-L]
Mode	(B)	• PB
Equipment	(C)	• Oscilloscope
Measuring point	(D)	• TP106 (PB. FM)
External trigger	(E)	• TP111 (D.FF)
Adjustment part	(F)	• Guide roller [Mechanism assembly]
Specified value	(G)	• Flat V.PB FM waveform
Adjustment tool	(H)	• Roller driver [PTU94002]

- (1) Play back the alignment tape (A1).
- (2) Apply the external trigger signal to D.FF (E), to observe the V.PB FM waveform at the measuring point (D).
- (3) Set the VCR to the manual tracking mode.
- (4) Make sure that there is no significant level drop of the V.PB FM waveform caused by the tracking operation, with its generally parallel and linear variation ensured. Perform the following adjustments when required. (See Fig. 4-2c.)
- (5) Reduce the V.PB FM waveform by the tracking operation. If a drop in level is found on the left side, turn the guide roller of the pole base assembly (supply side) with the roller driver to make the V.PB FM waveform linear. If a drop in level is on the right side, likewise turn the guide roller of the pole base assembly (take-up side) with the roller driver to make it linear. (See Fig. 4-2c.)
- (6) Make sure that the V.PB FM waveform varies in parallel and linearly with the tracking operation again. When required, perform fine-adjustment of the guide roller of the pole base assembly (supply or take-up side).
- (7) Unload the cassette tape once, play back the alignment tape (A1) again and confirm the V.PB FM waveform.
- (8) After adjustment, confirm that the tape wrinkling does not occur at the roller upper or lower limits. (See Fig. 4-2b.) [Perform adjustment step (9) only for the models equipped with SP mode and EP (or LP) mode.]

**[Perform adjustment step (9) only for the models equipped with SP mode and EP (or LP) mode.]**

- (9) Repeat steps (1) to (8) by using the alignment tape (A2).

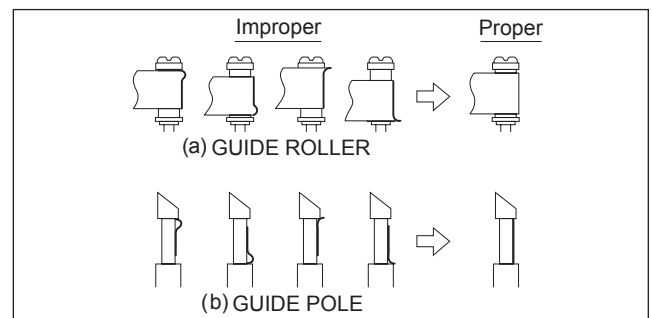

Fig.4-2b

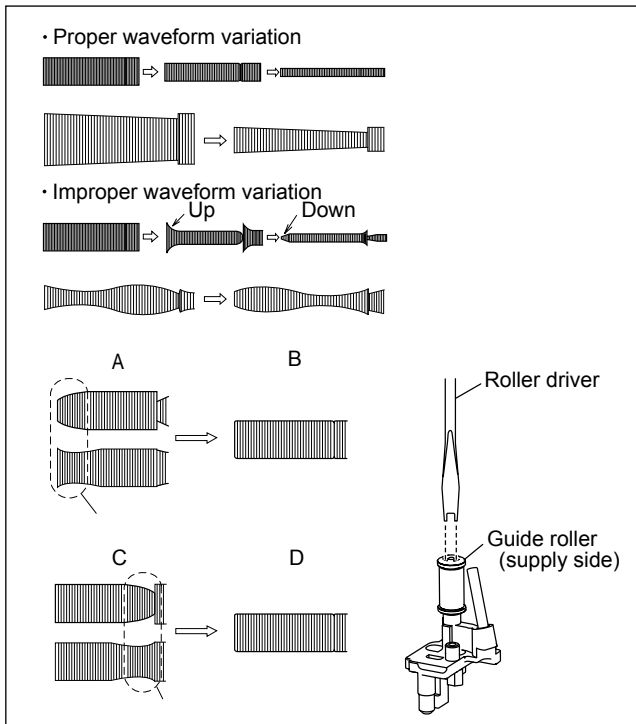

Fig.4-2c

#### 4.2.3 Height and tilt of the A/C head

**Note:**

- Set a temporary level of the height of the A/C head in advance to make the adjustment easier after the A/C head has been replaced. (Refer to the SERVICE MANUAL No.86700 [MECHANISM ASSEMBLY].)

Signal	(A)	• Alignment tape(SP, stairstep, NTSC) [MHP]
Mode	(B)	• PB
Equipment	(C)	• Oscilloscope
Measuring point	(D1)	• TP106 (PB, FM)
	(D2)	• TP4001 (CTL, P)
External trigger	(E)	• TP111 (D,FF)
Adjustment part	(F)	• A/C head [Mechanism assembly]
Specified value	(G)	• Maximum waveform

- (1) Play back the alignment tape (A).
- (2) Apply the external trigger signal to D.FF (E), to observe the AUDIO OUT waveform and Control pulse waveform at the measuring points (D1) and (D2) in the ALT mode.
- (3) Set the VCR to the manual tracking mode.
- (4) Adjust the AUDIO OUT waveform and Control pulse waveform by turning the screws (1), (2) and (3) little by little until both waveforms reach maximum. The screw (1) and (3) are for adjustment of tilt and the screw (2) for azimuth.

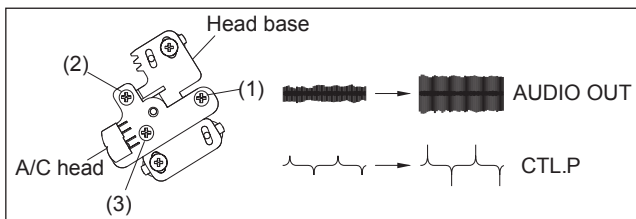

Fig.4-2d

#### 4.2.4 A/C head phase (X-value)

Signal	(A1)	• Alignment tape(SP, stairstep, NTSC) [MHP]
	(A2)	• Alignment tape(EP, stairstep, NTSC) [MHP-L]
Mode	(B)	• PB
Equipment	(C)	• Oscilloscope
Measuring point	(D)	• TP106 (PB, FM)
External trigger	(E)	• TP111 (D,FF)
Adjustment part	(F)	• A/C head base [Mechanism assembly]
Specified value	(G)	• Flat V.PB FM waveform
Adjustment tool	(H)	• Roller driver [PTU94002]

- (1) Play back the alignment tape (A1).
- (2) Apply the external trigger signal to D.FF (E), to observe the V.PB FM waveform at the measuring point (D).
- (3) Set the VCR to the manual tracking mode.
- (4) Loosen the screws (4) and (5), then set the Roller driver to the innermost projected part of the A/C head. (See Fig. 4-2e.)
- (5) Rotate the roller driver so that the A/C head comes closest to the capstan. From there, move the A/C head back gradually toward the drum until the point where the FM waveform is maximized for the second time, and then tighten the screws (4) and (5) temporarily.
- (6) Play an alignment tape (A2) and set to the manual-tracking mode.
- (7) Fine-adjust A/C head base position to maximize the FM waveform, and then tighten the screws (4) and (5) firmly.
- (8) Play alignment tapes (A1) and (A2) and confirm that the FM waveforms are maximized when the tracking is at the center position.

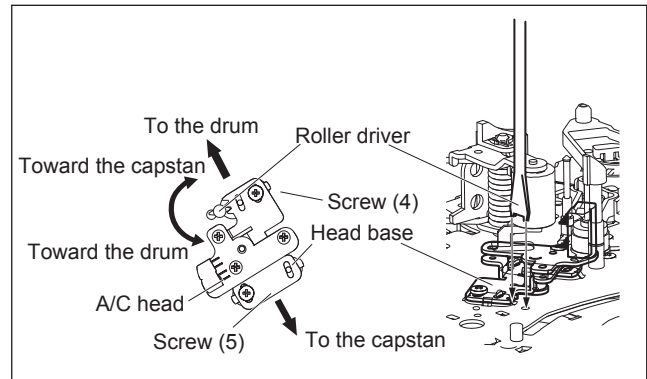

Fig.4-2e

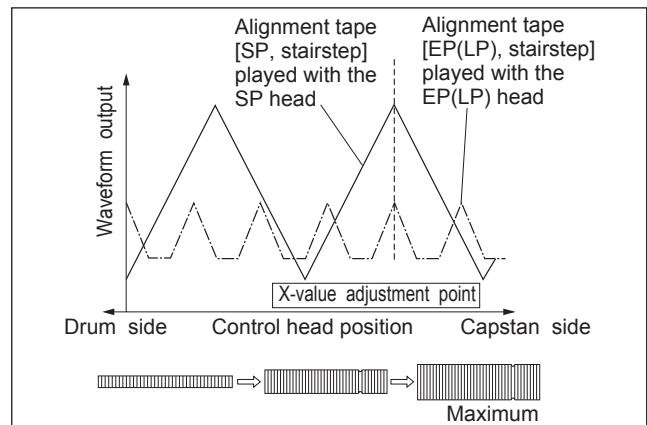

Fig.4-2f

### 4.3 Electrical adjustment

#### Note:

The following adjustment procedures are not only necessary after replacement of consumable mechanical parts or board assemblies, but are also provided as references to be referred to when servicing the electrical circuitry.

In case of trouble with the electrical circuitry, always begin a service by identifying the defective points by using the measuring instruments as described in the following electrical adjustment procedures. After this, proceed to the repair, replacement and/or adjustment. If the required measuring instruments are not available in the field, do not change the adjustment parts (variable resistor, etc.) carelessly.

#### 4.3.1 Servo circuit

##### 4.3.1.1 Switching point

Signal	(A1) (A2)	• Stairstep signal • Alignment tape(EP,stairstep,NTSC) [MHP-L]
Mode	(B)	• PB
Equipment	(C)	• Oscilloscope
Measuring point	(D)	• VIDEO OUT terminal (75 ohm terminated) • TP106 (PB, FM)
External trigger	(E)	• TP111 (D,FF)
Adjustment part	(F)	• Jig RCU: Code "5A"
Specified value	(G)	• $6.5 \pm 0.5H$
Adjustment tool	(H)	• Jig RCU [PTU94023B]

- (1) Play back the signal (A1) of the alignment tape (A2).
- (2) Apply the external trigger signal to D.FF (E) to observe the VIDEO OUT waveform and V.PB FM waveform at the measuring points (D1) and (D2).
- (3) Set the VCR to the manual tracking mode.
- (4) Adjust tracking so that the V.PB FM waveform becomes maximum.
- (5) Set the VCR to the Auto adjust mode by transmitting the code (F) from the Jig RCU. When the VCR enters the stop mode, the adjustment is completed.
- (6) If the VCR enters the eject mode, repeat steps (1) to (5) again.
- (7) Play back the alignment tape (A2) again, confirm that the switching point is the specified value (G).

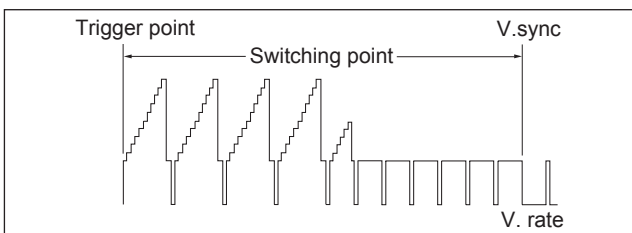

Fig.4-3a Switching point

##### 4.3.1.2 Slow tracking preset

Signal	(A1) (A2)	• Ext. input • Color (colour) bar signal [NTSC]
Mode	(B1) (B2)	• VHS SP • VHS EP
Measuring point	(D)	• TV-Monitor
Adjustment part	(F)	• Jig RCU: Code "71" or "72"
Specified value	(G)	• minimum noise
Adjustment tool	(H)	• Jig RCU [PTU94023B]

- (1) Record the signal (A2) in the mode (B1), and play back the recorded signal.
- (2) Set the VCR to the manual tracking mode.
- (3) Set the VCR to the FWD slow (+1/6x) mode.
- (4) Transmit the code (F) from the Jig RCU to adjust so that the noise bar becomes the specified value (G) on the TV monitor in the slow mode.
- (5) Set the VCR to the Stop mode.
- (6) Confirm that the noise bar is (G) on the TV monitor in the slow mode.
- (7) Repeat steps (3) to (6) in the REV slow (+1/6x) mode.
- (8) Repeat steps (1) to (7) in the mode (B2).

#### Note:

- For FWD slow (+1/6x) playback, transmit the code "08" from the Jig RCU to enter the slow playback mode, and transmit the code "D0" for REV slow (-1/6x) mode.

#### 4.3.2 DVD Video circuit

##### Note

- when perform these adjustments, set the unit to DVD mode.(DVD lamp lights up)

##### 4.3.2.1 EE COMPONENT Y level

Signal	(A)	• Internal color bar
Mode	(B)	• EE
Equipment	(C)	• Oscilloscope
Measuring point	(D)	• COMPONENT Y terminal
EVR mode	(F1)	• Jig code "95"
EVR address	(F2)	• "ADJUST01 : ***"
	(F3)	• Jig code "21"
	(F4)	• Jig code "18" or "19" (Channel +/-)
	(F5)	• Jig code "3C"
Specified value	(G)	• $1.00 \pm 0.02$ Vp-p (terminated)
Adjustment tool	(H)	• Jig RCU [PTU94023B]

- (1) Observe the Y OUT waveform at the measuring point (D).
- (2) Set the VCR to the EVR mode by transmitting the code (F1) from the Jig RCU.
- (3) Set the EVR address to (F2) by transmitting the code (F3) from the Jig RCU.
- (4) Transmit the code (F4) from the Jig RCU to adjust so that the Y level of the Y OUT waveform becomes the specified value (G).
- (5) Release the EVR mode of the VCR by transmitting the code (F5) from the Jig RCU again. (When the EVR mode is released, the adjusted data is memorized.)

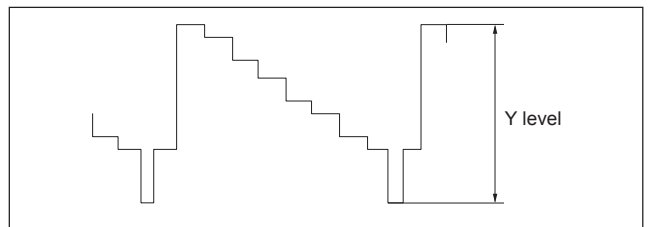

Fig.4-3b EE component Y level

#### 4.3.2.2 EE Y level

Signal	(A1)	• Ext. input
	(A2)	• Color (colour) bar signal
Mode	(B)	• EE
Equipment	(C)	• Oscilloscope
Measuring point	(D)	• Y OUT (S terminal)
EVR mode	(F1)	• Jig code "95"
EVR address	(F2)	• "ADJUST02 : ***"
	(F3)	• Jig code "22"
	(F4)	• Jig code "18" or "19" (Channel +/-)
	(F5)	• Jig code "3C"
Specified value	(G)	• 1.00 ± 0.02 Vp-p (terminated)
Adjustment tool	(H)	• Jig RCU [PTU94023B]

- (1) Observe the Y OUT waveform at the measuring point (D).
- (2) Set the VCR to the EVR mode by transmitting the code (F1) from the Jig RCU.
- (3) Set the EVR address to (F2) by transmitting the code (F3) from the Jig RCU.
- (4) Transmit the code (F4) from the Jig RCU to adjust so that the Y level of the Y OUT waveform becomes the specified value (G).
- (5) Release the EVR mode of the VCR by transmitting the code (F5) from the Jig RCU again. (When the EVR mode is released, the adjusted data is memorized.)

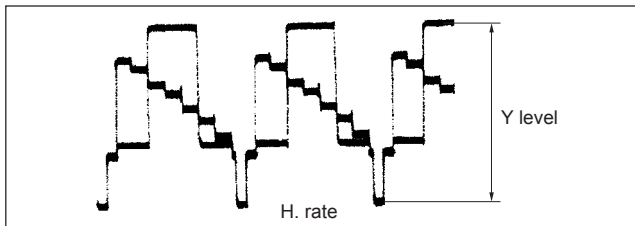

Fig.4-3c EE Y level

#### 4.3.2.3 EE COMPONENT PB/CB level

Signal	(A)	• Internal color bar
Mode	(B)	• EE
Equipment	(C)	• Oscilloscope
Measuring point	(D)	• COMPONENT PB/CB terminal
EVR mode	(F1)	• Jig code "95"
EVR address	(F2)	• "ADJUST06 : ***"
	(F3)	• Jig code "26"
	(F4)	• Jig code "18" or "19" (Channel +/-)
	(F5)	• Jig code "3C"
Specified value	(G)	• 0.70 ± 20 Vp-p (terminated)
Adjustment tool	(H)	• Jig RCU [PTU94023B]

- (1) Observe the CB OUT waveform at the measuring point (D).
- (2) Set the VCR to the EVR mode by transmitting the code (F1) from the Jig RCU.
- (3) Set the EVR address to (F2) by transmitting the code (F3) from the Jig RCU.
- (4) Transmit the code (F4) from the Jig RCU to adjust so that the CB level of the CB OUT waveform becomes the specified value (G).
- (5) Release the EVR mode of the VCR by transmitting the code (F5) from the Jig RCU again. (When the EVR mode is released, the adjusted data is memorized.)

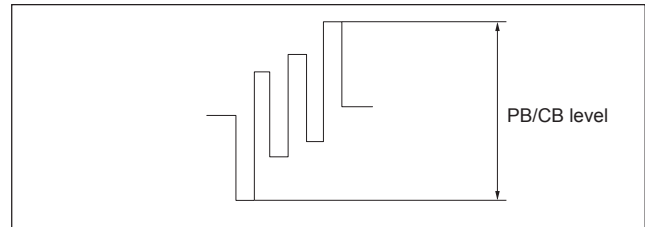

Fig.4-3d EE component PB/CB level

#### 4.3.3 Syscon circuit

##### Notes:

- When perform this adjustment, remove the Mechanism assembly.

##### 4.3.3.1 Timer clock

Signal	(A)	• No signal
Mode	(B)	• EE
Equipment	(C)	• Frequency counter
Measuring point	(D1)	• IC3001 pin 61
	(D2)	• IC3001 pin 24
	(D3)	• C3026 + and -
Adjustment part	(F)	• C3025 (TIMER CLOCK)
Specified value	(G)	• 1024.008 ± 0.001 Hz (976.5549 ± 0.0010 usec)

- (1) Connect the frequency counter to the measuring point (D1).
- (2) Connect the short wire between the short point (D2) and Vcc (5V).
- (3) Short the leads of capacitor (D3) once in order to reset the microprocessor of the Syscon.
- (4) Disconnect the short wire between the short point (D2) and Vcc then connect it again.
- (5) Adjust the Adjustment part (F) so that the output frequency becomes the specified value (G).

## SECTION 5 TROUBLESHOOTING

### 5.1 Manually removing the cassette tape

If you cannot remove the cassette tape which is loaded because of any electrical or mechanical failures, manually remove it by taking the following steps.

- (1) Unplug the power cord plug from the power outlet.
- (2) Refer to the disassembly procedure of the VCR and perform the disassembly of the major parts before removing the mechanism assembly. (See Fig. 5-1a)

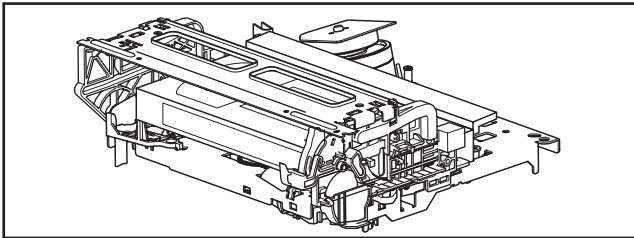

Fig.5-1a

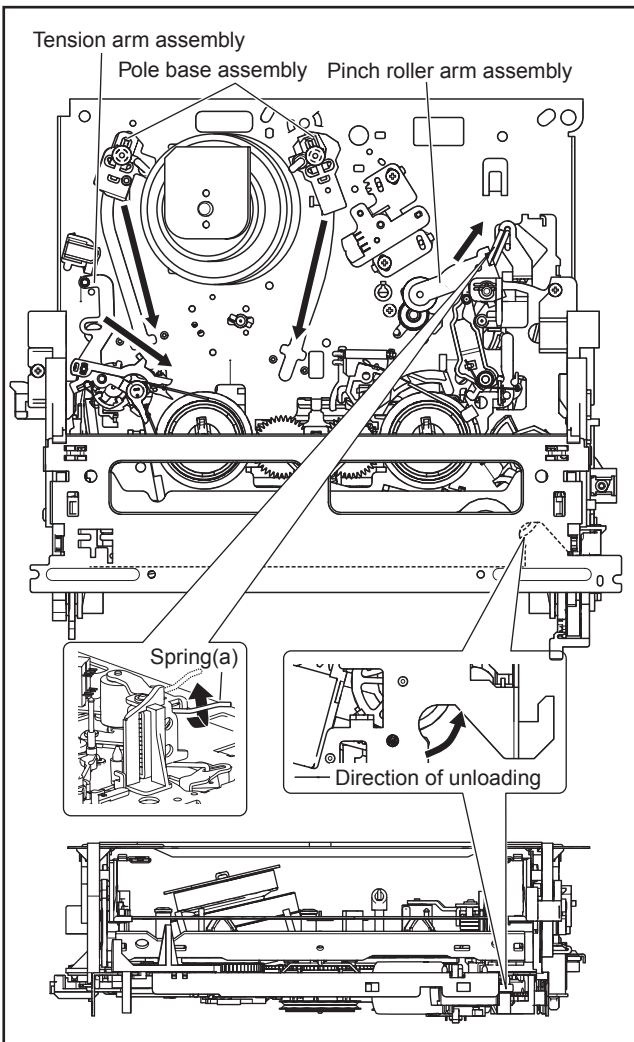

Fig.5-1b

- (3) Unload the pole base assembly by manually turning the gear of the loading motor until the pole base assembly is hidden behind the cassette lid. In doing so, hold the tape by the hand to keep the slack away from any grease. (See Fig.5-1b )

**In case of mechanical failures, while keeping the ten-**

**sion arm assembly free from tension, pull out the tape on the pole base assembly. Take the spring(a) of the pinch roller arm assembly off the hook, and detach it from the tape.**

- (4) Remove the screw (a) of the side frame (L/R).
- (5) Hold the slack tape and cassette cover together, lift the cassette tape, top frame, cassette holder and side frames (L, R) together from the rear and remove them by disengaging the hooks (a) and (b).

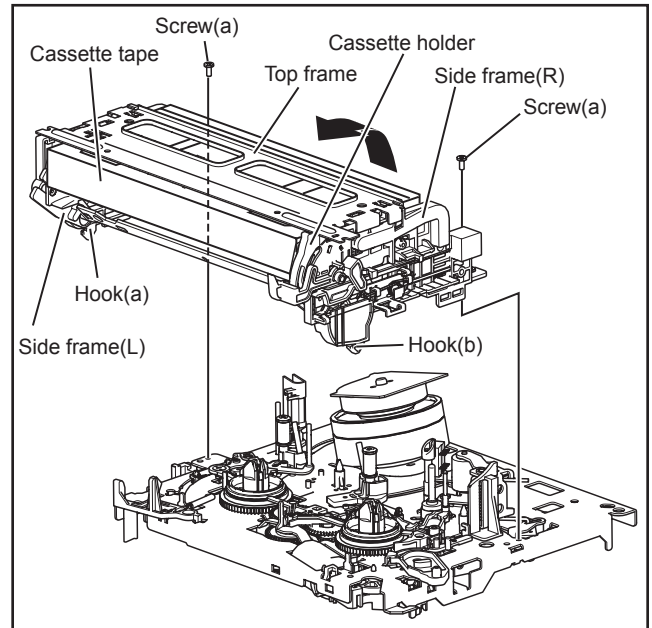

Fig.5-1c

- (6) Take up the slack of the tape into the cassette. This completes removal of the cassette tape.

### 5.2 Manually removing the disk(DVD/CD)

If you cannot remove the disk which is loaded because of any electrical or mechanical failures, manually remove it by taking the following steps.

#### 5.2.1 Method 1

- (1) AC Plug is pulled out at once and inserted again.
- (2) It is displayed on FDP as "LOADING", and while it blinks, pushing the OPEN/CLOSE button is continued.
- (3) After a while, a tray opens (About 20 seconds).
- (4) After removed a disk, press the OPEN/CLOSE button again to close the tray.
- (5) The "LOADING" blink display of FDP disappears and it will be in a standby mode.
- (6) If the POWER button is pushed, it will usually be operating.

#### 5.2.2 Method 2

- (1) Unplug the ACpower cord from the AC outlet.
- (2) Remove the top cover and front panel assembly. (Refer to the disassembly procedure and perform the disassembly of the major parts before removing)
- (3) Pass a thin wire through a hole in the DVD unit.
- (4) The disc tray comes out slightly. Take out the disc tray manually.(See Fig.5-2a)

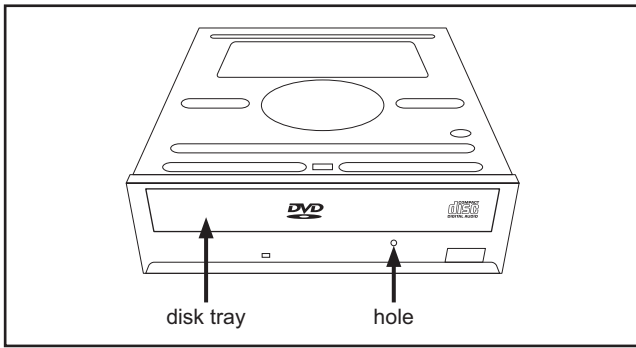

Fig.5-2a

### 5.3 Emergency display function (VHS SECTION)

This unit saves details of the last two emergencies as the EMG history and allows the status of the VCR and the mechanism of each emergency to be shown both on the display and as OSD information.

When using the emergency function, it is required to set the VCR to the Jig RCU mode.

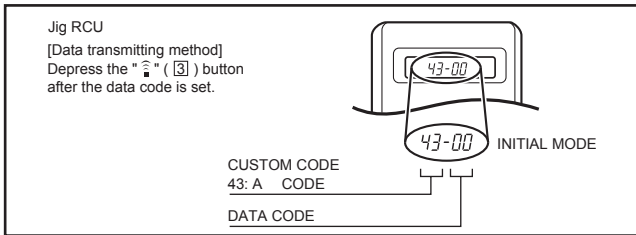

Fig.5-3a Jig RCU [PTU94023B]

#### 5.3.1 Displaying the EMG information

The EMG detail of information can be displayed by transmitting the code "59" from the Jig RCU.

##### Note:

- The EMG detail information <1><2> show the information on the latest EMG. It becomes " - - : - - : - - " when there is no latest EMG record.

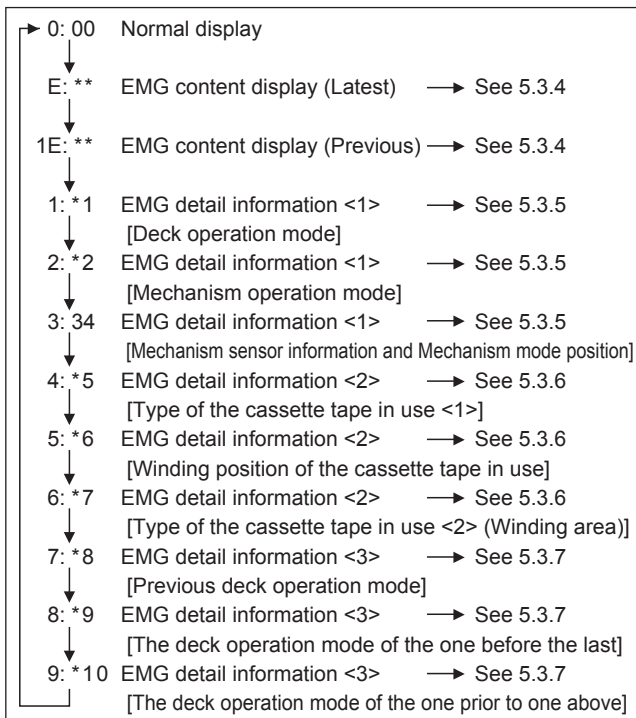

EMG display of 7 FDP display model

Fig.5-3b

#### EMG display of FDP display mode

- (1) Transmit the code "59" from the Jig RCU. The FDP shows the EMG content in the form of "E:\*\*:\*\*".

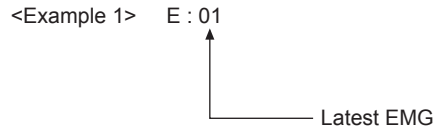

- (2) Transmit the code "59" from the Jig RCU again. The FDP shows the EMG detail information <1> in the form of "\*1: \*2 : 34".

- \*1 : Deck operation mode at the moment of EMG
- \*2 : Mechanism operation mode at the moment of EMG
- 3- : Mechanism sensor information at the moment of EMG
- 4 : Mechanism mode position at the moment of EMG

- (3) Transmit the code "59" from the Jig RCU once again. The FDP shows the EMG detail information <2> in the form of "\*5 : \*6 : \*7".

- \*5 : Type of the cassette tape in use <1> .
- \*6 : Winding position of the cassette tape in use
- \*7 : Type of the cassette tape in use <2> (Winding area)

- (4) Transmit the code "59" from the Jig RCU once again. The FDP shows the EMG detail information <3> in the form of "\*8 : \*9 : \*10".

- \*8 : Previous deck operation mode at the moment of EMG
- \*9 : The deck operation mode of the one before the last at the moment of EMG
- \*10: The deck operation mode of the one prior to one above at the moment of EMG

- (5) Transmit the code "59" from the Jig RCU once again to reset the display.

#### 5.3.2 Clearing the EMG history

- (1) Display the EMG history.
- (2) Transmit the code "36" from the Jig RCU.
- (3) Reset the EMG display.

#### 5.3.3 Details of the OSD display in the EMG display mode

During the EMG display, the OSD shows the data on the deck mode, etc. The details of the display contents are as follows.

##### Notes:

- The display is variable depending on the part No. of the System Control microcomputer (IC3001) built into the VCR. In the following, refer to the figure carrying the same two characters as the top two characters of the part number of your IC.
- The sensor information in the OSD display contents is partially different from the mechanism sensor information in EMG detail information <1>.

[For MN\* only]

AA	BB	CC	DD	EE
FF	GG	HH	II	JJ
KK	LL	MM	NN	OO
PP	QQ	RR	SS	TT
UU	VV	WW	XX	YY



- AA : Deck operation mode (See EMG detail information <1>.)
- BB : Mechanism operation mode (See EMG detail of information <1>.)
- CC : Mechanism transition flag
- DD : Capstan motor control status
- EE : Loading motor control status
- FF : Sensor information (See sensor information details.)
- GG : Capstan motor speed
- HH : Key code (JVC code)
- II : Supply reel winding diameter data higher 8 bits.
- JJ : Supply reel winding diameter data lower 8 bits.
- KK : Mechanism sensor information & mechanism mode position (See EMG detail of information <1>.)
- LL : Tape speed data higher 8 bits.
- MM : Tape speed data lower 8 bits.
- NN : Cassette tape type <2> higher 8 bits. (See EMG detail of information <2>.)
- OO : Cassette tape type <2> lower 8 bits. (See EMG detail of information <2>.)
- PP : General data display area
- YY : General data display area

**\*FF:Sensor information details**

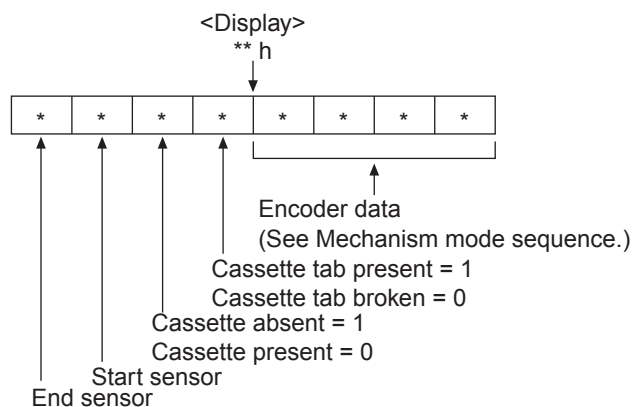

**[For \*HD only]**

AA	BB	CC
DD	EE	FF
GGGG	HHHH	
II	JJJJ	
KKKK	LLLL	MMMM
ROM No.		

- AA : Key code (JVC code)
- BB : Deck operation mode (See EMG detail information <1>.)
- CC : Mechanism operation mode (See EMG detail information <1>.)
- DD : Sensor information (See sensor information details.)
- EE : Capstan motor speed (Search, double speed)
- FF : Tracking value
- GGGG : Cassette tape type <2>, 16 bits. (See EMG detail information <2>.)
- HHHH : Supply reel winding diameter data
- II : Capstan motor speed (FF/REV, double speed)
- JJJJ : Tape speed data, lower 8 bits.
- KKKK : General data display area
- LLLL : General data display area
- MMMM : General data display area

**\*DD:Sensor information details**

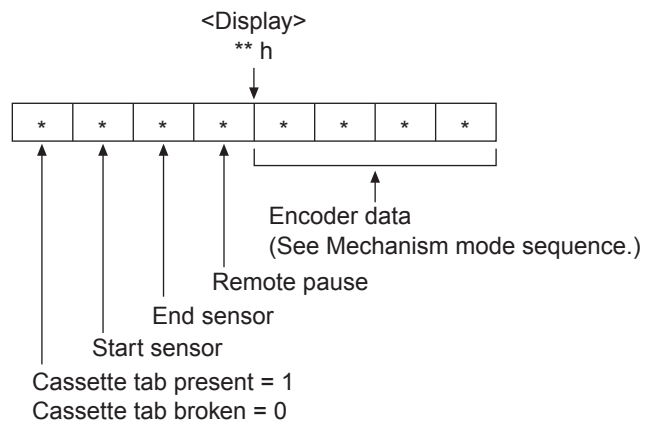

**[For both MN\*/HD\*]**

**Mechanism mode sequence**

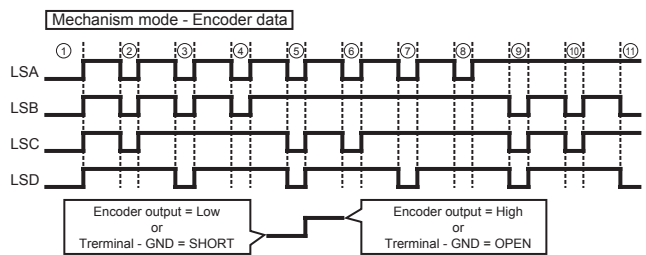

No.	Position	Encoder data
①	EJECT	0 h = 0000
②	EJECT1	1 h = 0001
③	EJECT2	2 h = 0010
④	ULSTOP	3 h = 0011
⑤	UPPER	4 h = 0100
⑥	ONSTOP(PLAY)	5 h = 0101
⑦	FWD/SS	6 h = 0110
⑧	REV/SS	7 h = 0111
⑨	OFFSTOP	8 h = 1000
⑩	FFREW-BRAKE	9 h = 1001
⑪	FFREW	A h = 1010
⑫	MIDDLE	F h = 1111

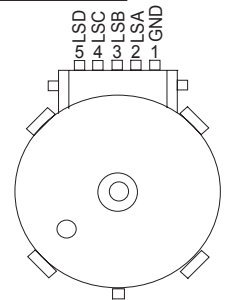

### 5.3.4 EMG content description

**Note:**

**EMG contents "E09" are for the model with Dynamic Drum (DD).**

FDP	CONTENT	CAUSE
E01: Loading EMG	If the mechanism mode does not change to the next mode within 4 seconds after the loading motor starts rotating in the loading direction, while the mechanism is in the after-loading position (with the tape up against the pole base), [E:01] is identified and the power is switched OFF. However, if the tape loading is not completed within 4 seconds after the loading motor starts rotating in the loading direction, the tape is simply unloaded and ejected. No EMG data is recorded in this case.	<ol style="list-style-type: none"> <li>The mechanism is locked in the middle of the mode transition during a tape loading operation.</li> <li>The mechanism overruns during the tape loading operation because the SYSCON cannot recognize the mechanism mode normally. This problem is due to a cause such as a rotary encoder failure.</li> <li>Power is not supplied to the loading MDA. (M12V/Vcc/Vref/ICP are disconnected in the middle.)</li> </ol>
E02: Unloading EMG	When the mechanism mode cannot be changed to another mode even when the loading motor has rotated for more than 4 seconds in the unloading direction, [E:02] is identified and the power is turned off.	<ol style="list-style-type: none"> <li>The mechanism is locked in the middle of mode transition.</li> <li>Without an eject signal being sent from the SYSCON, unloading is attempted (i.e. Ejection is attempted while the tape is still inside the mechanism.) because the SYSCON cannot recognize the mechanism mode normally. This is due to a cause such as a rotary encoder failure. (Mechanism position: UPPER)</li> <li>Power is not supplied to the loading MDA. (M12V/Vcc/Vref/ICP are disconnected in the middle.)</li> </ol>
E03: Take Up Reel Pulse EMG	When the falling edge of the take-up reel pulse has not been generated for more than 4 seconds in the capstan rotating mode, [E:03] is identified, the pinch rollers are turned off and stopped, and the power is turned off. In this case, however, the mechanism should be in position after tape loading. Note that the reel EMG is not detected during Slow/Frame advance operations.	<ol style="list-style-type: none"> <li>The take-up reel pulse is not generated in the FWD transport modes (PLAY/FWD SEARCH/FF, etc.) because; <ol style="list-style-type: none"> <li>The idler gear is not meshed with the take-up reel gear because the mechanism mal-functions for some reason.</li> <li>The idler gear is meshed with the take-up reel gear, but incapable of winding due to too large mechanical load (abnormal tension);</li> <li>The reel is rotating normally but an FG pulse is not generated due to the take-up reel sensor failure.</li> </ol> </li> <li>The supply reel pulse is not generated in the REV transport modes (REV SEARCH/REW, etc.) because; <ol style="list-style-type: none"> <li>The idler gear is not meshed with the supply reel gear because the mechanism mal-functions for some reason.</li> <li>The idler gear is meshed with the supply reel gear, but incapable of winding due to too large a mechanical load (abnormal tension);</li> <li>The reel rotates normally but the FG pulse is not generated due to a supply reel sensor failure.</li> </ol> </li> <li>Power(SW5V) is not supplied to the reel sensor on the tape winding side.</li> </ol>
E04: Drum FG EMG	When the drum FG pulse has not been input for more than 3 seconds in the drum rotating mode, [E:04] is identified, the pinch rollers are turned off and stopped, and the power is turned off.	<ol style="list-style-type: none"> <li>The drum could not start or the drum rotation has stopped due to too large a load on the tape, because; <ol style="list-style-type: none"> <li>The tape tension is abnormally high;</li> <li>The tape is damaged or a foreign object (grease, etc.) adheres to the tape.</li> </ol> </li> <li>The drum FG pulse did not reach the System controller CPU because; <ol style="list-style-type: none"> <li>The signal circuit is disconnected in the middle;</li> <li>The FG pulse generator (hall device) of the drum is faulty.</li> </ol> </li> <li>The drum control voltage (DRUM CTL V) is not supplied to the MDA.</li> <li>Power (M12V) is not supplied to the drum MDA.</li> </ol>
E05: Cassette Eject EMG	If the cassette does not reach the eject position within about 0.7 seconds after the cassette housing has started the cassette ejection operation, [E:05] is identified, the drive direction is reversed to load the tape, the mode is switched to STOP mode with the pinch roller OFF, and the power is switched OFF. During the cassette insertion process, the drive direction is reversed and the cassette is ejected if the tape is not up against the pole base within about 3 seconds after the start of the cassette pulling-in operation. If the cassette does not reach the eject position within about 0.7 seconds after the drive mode reversal operation, [E:05] is identified and the power is switched OFF immediately.	<ol style="list-style-type: none"> <li>The cassette cannot be ejected due to a failure in the drive mechanism of the housing.</li> <li>When the housing load increases during ejection, the loading motor is stopped because of lack of headroom in its drive torque. Housing load increasing factors: Temperature environment (low temperature, etc.), mechanism wear or failure.</li> <li>The sensor/switch for detecting the end of ejection are not functioning normally.</li> <li>The loading motor drive voltage is lower than specified or power (M12V) is not supplied to the motor (MDA).</li> <li>When the user attempted to eject a cassette, a foreign object (or perhaps the user's hand) was caught in the opening of the housing.</li> </ol>
E06: Capstan FG EMG	When the capstan FG pulse has not been generated for more than 1 second in the capstan rotating mode, [E:06] is identified, the pinch rollers are turned off and stopped, and the power is turned off. However, the capstan EMG is not detected in SLOW/STILL modes. Note that, if the part number of the System Control IC begins with "MN" or "M3", the capstan EMG is not detected even during the FF/REW operation.	<ol style="list-style-type: none"> <li>The capstan could not start or the capstan rotation has stopped due to too large a load on the tape, because; <ol style="list-style-type: none"> <li>The tape tension is abnormally high (mechanical lock);</li> <li>The tape is damaged or a foreign object (grease, etc.) is adhered to the tape (occurrence of tape entangling, etc.).</li> </ol> </li> <li>The capstan FG pulse did not reach the System controller CPU because; <ol style="list-style-type: none"> <li>The signal circuit is disconnected in the middle;</li> <li>The FG pulse generator (MR device) of the capstans is faulty.</li> </ol> </li> <li>The capstan control voltage (CAPSTAN CTL V) is not supplied to the MDA.</li> <li>Power (M12V, SW5V) are not supplied to the capstan MDA.</li> </ol>
E07: SW Power Short-Circuit EMG	When short-circuiting of the SW power supply with GND has lasted for 0.5 second or more, [E:07] is identified, all the motors are stopped and the power is turned off.	<ol style="list-style-type: none"> <li>The SW 5 V power supply circuit is shorted with GND.</li> <li>The SW 12 V power supply circuit is shorted with GND.</li> </ol>
E08: DVD EMG	When communication with a system computer of VHS side is not carried out because of the defective DVD unit, or when the DVD unit must be reset	<ol style="list-style-type: none"> <li>The DVD unit is defective.</li> <li>Contact failure of the wires in the DVD unit or VHS side.</li> </ol>
E09: DD FG EMG	When the DD FG pulse is not generated within 2.5 seconds, [E:09] is identified, the tilt motor is stopped and the power is turned off.	<ol style="list-style-type: none"> <li>The FG sensor is defective. (The soldered parts have separated.)</li> <li>The pull-up resistor at the FG sensor output is defective. (The soldered parts have separated.)</li> <li>Contact failure or soldering failure of the pins of the connector (board-to-board) to the FG sensor.</li> <li>The power (5V) to the sensor is not supplied. (Connection failure/soldering failure)</li> <li>The FG pulse is not sent to the System Controller CPU.</li> <li>The tilt motor is defective. (The soldered parts have separated.)</li> <li>The drive power to the tilt motor is not supplied. (Connection failure/soldering failure)</li> <li>The tilt motor drive MDA - IC is defective.</li> <li>Auto-recovery of the DD tilting cannot take place due to overrun.</li> </ol>
E0A: Supply Reel Pulse EMG	When the falling edge of the supply reel pulse has not been generated for more than 10 seconds in the capstan rotating mode, [E:0A] is identified and the cassette is ejected (but the power is not turned off). In this case, however, the mechanism should be in the position after tape loading (with the tape up against the pole base). Also note that the reel EMG is not detected during Slow/Frame advance operations.	<ol style="list-style-type: none"> <li>The supply reel pulse is not generated in the FWD transport mode (PLAY/FWD SEARCH/FF, etc.) because; <ol style="list-style-type: none"> <li>PLAY/FWD or SEARCH/FF is started while the tape in the inserted cassette is cut in the middle;</li> <li>A mechanical factor caused tape slack inside and outside the supply reel side of the cassette shell. In this case, the supply reel will not rotate until the tape slack is removed by the FWD transport, so the pulse is not generated until then;</li> <li>The reel is rotating normally but the FG pulse is not generated due to a supply reel sensor failure.</li> </ol> </li> <li>The take-up reel pulse is not generated in the REV transport mode (REV SEARCH/REW, etc.). <ol style="list-style-type: none"> <li>REV SEARCH/REW is started when the tape in the inserted cassette has been cut in the middle;</li> <li>A mechanical factor caused tape slack inside and outside the take-up reel side of the cassette shell. In this case, the take up will not rotate until the tape slack is removed by the REV transport, so the pulse will not be generated until that time;</li> <li>The reel is rotating normally but the FG pulse is not generated due to a take-up reel sensor failure.</li> </ol> </li> <li>The power (SW 5V) to a reel sensor is not supplied.</li> </ol>
EU1: Head clog warning history	Presupposing the presence of the control pulse output in the PLAY mode, when the value obtained by mixing the two V.FM output channels (without regard to the A.FM output) has remained below a certain threshold level for more than 10 seconds, [E:U1] is identified and recorded in the emergency history. During the period in which the head clog is detected, the FDP shows "U:01" and the OSD repeats the "3 seconds of warning display" and the "7 seconds of noise picture display" alternately. EMG code : "E:C1" or "E:U1" / FDP : "U:01" / OSD : "Try cleaning tape." or "Use cleaning cassette." The head clog warning is reset when the above-mentioned threshold has been exceeded for more than 2 seconds or the mode is changed to another mode than PLAY.	

### 5.3.5 EMG detail information <1>

The status (electrical operation mode) of the VCR and the status (mechanism operation mode/sensor information) of the mechanism in the latest EMG can be confirmed based on the figure in EMG detail information <1> .

[FDP/OSD display] \*1 : \*2 : 34

- \*1 : Deck operation mode at the moment of EMG
- \*2 : Mechanism operation mode at the moment of EMG
- 3- : Mechanism sensor information at the moment of EMG
- 4 : Mechanism mode position at the moment of EMG

#### Note:

- For EMG detailed information <1>, the content of the code that is shown on the display (or OSD) differs depending on the parts number of the system control microprocessor (IC3001) of the VCR. The system control microprocessor parts number starts with two letters, refer these to the corresponding table.

#### \*1 : Deck operation mode

[Common table of MN\* and HD]

Display		Deck operation mode
MN*	HD*	
00	-	Mechanism being initialized
01	00	STOP with pinch roller pressure off (or tape present with P.OFF)
02	01	STOP with pinch roller pressure on
03	-	POWER OFF as a result of EMG
04	04	PLAY (Normal playback)
0C	0E	REC
10	11	Cassette ejected
20	22	FF
21	-	Tape fully loaded, START sensor ON, short FF
22	-	Cassette identification FWD SEARCH before transition to FF (SPx7-speed)
24	26	FWD SEARCH (variable speed) including x2-speed
2C	2E	INSERT REC
40	43	REW
42	-	Cassette identification REV SEARCH before transition to REW (SPx7-speed)
44	47	REV SEARCH (variable speed)
4C	4C	AUDIO DUB
6C	6E	INSERT REC (VIDEO + AUDIO)
84	84	FWD STILL / SLOW
85	85	REV STILL / SLOW
8C	8F	REC PAUSE
8D	-	Back spacing
8E	-	Forward spacing (FWD transport mode with BEST function)
AC	AF	INSERT REC PAUSE
AD	-	INSERT REC back spacing
CC	CD	AUDIO DUB PAUSE
CD	-	AUDIO DUB back spacing
EC	EF	INSERT REC (VIDEO + AUDIO) PAUSE
ED	-	INSERT REC (VIDEO + AUDIO) back spacing

### \*2 : Mechanism operation mode

[Table of MN\*]

Display	Mechanism operation mode
00	Command standby (No command to be executed)
01	Immediate Power OFF after EMG occurrence
02	Loading from an intermediate position during mechanism initialization
03	Unloading due to EMG occurrence during mechanism initialization
04	Ejecting cassette (ULSTOP to EJECT)
05	Inserting cassette (EJECT to ULSTOP)
06	Loading tape (ULSTOP to PLAY)
07	Unloading tape (PLAY to ULSTOP)
08	Transition from pinch roller ON to STOP
09	Transition from pinch roller OFF to STOP (PLAY to OFFSTOP)
0A	Transition from pinch roller OFF to STOP at power OFF
0B	Transition from pinch roller ON to STOP at power ON
0C	Transition to PLAY
0D	Transition to Search FF
0E	Transition to REC
0F	Transition to FWD STILL/SLOW
10	Transition to REV STILL/SLOW
11	Transition to Search REV
12	Transition from FF/REW to STOP
13	Transition to FF
14	Transition to REW
15	Tape end detection processing during loading
16	Short FWD/REV at tape sensor ON during unloading
17	Transition to FF/REW brake mode

[Table of HD\*]

Display	Mechanism operation mode
00	STOP with pinch roller pressure off
01	STOP with pinch roller pressure on
02	U/L STOP (or tape being loaded)
04	PLAY (Normal playback)
05	PLAY (x1-speed playback using JOG)
0E	REC
11	Cassette ejected
22	FF
26	FWD SEARCH (variable speed) including x2-speed
2E	INSERT REC
43	REW
47	REV SEARCH
4C	AUDIO DUB
6E	INSERT REC (VIDEO + AUDIO)
84	FWD STILL/SLOW
85	REV STILL/SLOW
8F	REC PAUSE
AF	INSERT REC PAUSE
C7	REV SEARCH (x1-speed reverse playback using JOG)
CD	AUDIO DUB PAUSE
EF	INSERT REC (VIDEO + AUDIO) PAUSE
F0	Mechanism being initialized
F1	POWER OFF as a result of EMG
F2	Cassette being inserted
F3	Cassette being ejected
F4	Transition from STOP with pinch roller pressure on to STOP with pinch roller pressure off
F5	Transition from STOP with pinch roller pressure on to PLAY
F6	Transition from STOP with pinch roller pressure on to REC
F7	Cassette type detection SEARCH before FF/REW is being executed
F8	Tape being unloaded
F9	Transition from STOP with pinch roller pressure off to STOP with pinch roller pressure on
FA	Transition from STOP with pinch roller pressure off to FF/REW
FB	Transition from STOP with pinch roller pressure off to REC.P (T.REC, etc.)
FC	Transition from STOP with pinch roller pressure off to cassette type detection SEARCH
FD	Short REV being executed after END sensor on during unloading
FE	Tension loosening being executed after tape loading (STOP with pinch roller pressure on)
FF	Tape being unloaded

### 3 : Mechanism sensor information

[Common table of MN\* and HD\*]

Display	Mechanism sensor information			
	REC safety SW	Start sensor	End sensor	Mechanism position sensor
0-	Tab broken	ON	ON	ON
1-	Tab broken	ON	ON	OFF
2-	Tab broken	ON	OFF	ON
3-	Tab broken	ON	OFF	OFF
4-	Tab present	OFF	ON	ON
5-	Tab present	OFF	ON	OFF
6-	Tab present	OFF	OFF	ON
7-	Tab present	OFF	OFF	OFF
8-	Tab broken	ON	ON	ON
9-	Tab broken	ON	ON	OFF
A-	Tab broken	ON	OFF	ON
B-	Tab broken	ON	OFF	OFF
C-	Tab present	OFF	ON	ON
D-	Tab present	OFF	ON	OFF
E-	Tab present	OFF	OFF	ON
F-	Tab present	OFF	OFF	OFF

Tab broken = 0      Sensor ON = 0      Sensor ON = 0  
 Tab present = 1      sensor OFF = 1      Sensor OFF = 1

### -4 : Mechanism mode position

[Common table of MN\* and HD\*]

Mechanism sensor information	Display	Deck operation mode	
Even number (0, 2, 4, 6, 8, A, C, E)	-0	Not established	
	-1	EJECT	EJECT position
	-2	EJECT-EJECT1	Intermodal position
	-3	EJECT1	EJECT1 position
	-4	EJECT1-EJECT2	Intermodal position
	-5	EJECT2	EJECT2 position
	-6	EJECT2-ULSTOP	Intermodal position
	-7	ULSTOP	ULSTOP position
	-8	ULSTOP-UPPER	Intermodal position
	-9	UPPER	Loading (unloading) tape
	-A	UPPER-ONSTOP	Intermodal position
	-B	ONSTOP	PLAY position
	-C	PLAY-FWD/SS	Intermodal position
	-D	FWD/SS	FWD (FWD Still/Slow) position
	-E	FWD/SS-REV	Intermodal position
	-F	REV	REV (REV Still/Slow) position
Odd number (1, 3, 5, 7, 9, B, D, F)	-0	REV-OFFSTOP	Intermodal position
	-1	OFFSTOP	Pinch roller OFF position
	-2	OFFSTOP-FFREWB	Intermodal position
	-3	FFREWB	FF/REW Brake position
	-4	FFREWB-FFREW	Intermodal position
-5	FFREW	FF/REW position	

#### 5.3.6 EMG detail information <2>

The type of the cassette tape and the cassette tape winding position can be confirmed based on the figure in EMG detail information <2> .

#### Note:

- EMG detail information <2> is the reference information stored using the remaining tape detection function of the cassette tape. As a result, it may not identify cassette correctly when a special cassette tape is used or when the tape has variable thickness.

### \*5 : Cassette tape type <1>

Display	Cassette tape type <1>
00	Cassette type not identified
16	Large reel/small reel (T-0 to T-15/T-130 to T-210) not classified
82	Small reel, thick tape (T-120) identified/thin tape (T-140) identified
84	Large reel (T-0 to T-60) identified
92	Small reel, thick tape (T-130) identified/thin tape (T-160 to T-210) identified
93	Small reel, thick tape/C cassette (T-0 to T-100/C cassette) not classified
C3	Small reel, thick tape/C cassette (T-0 to T-100/C cassette) being classified
D3	Small reel, thick tape/C cassette (T-0 to T-100/C cassette) being classified
E1	C cassette, thick tape (TC-10 to TC-20) identified
E2	Small reel, thick tape (T-0 to T-100) identified
E9	C cassette, thin tape (TC-30 to TC-40) identified
F1	C cassette, thick tape/thin tape (TC-10 to TC-40) not classified

#### Notes:

- Cassette tape type <1> is identified a few times during mode transition and the identification count is variable depending on the cassette tape type. If an EMG occurs in the middle of identification, the cassette tape type may not be able to be identified.
- If other value than those listed in the above table is displayed, the cassette tape type is not identified.

### \*6 : Cassette tape winding position

The cassette tape winding position at the moment of EMG is displayed by dividing the entire tape (from the beginning to the end) in 21 sections using a hex number from "00" to "14".

00 : End of winding  
 14 : Beginning of winding  
 FF : Tape position not identified

### \*7 : Cassette tape type <2> (Winding area)

Display	Cassette tape type <2>	(Reference) Word data (Beginning) (End)
00	Cassette type not identified	
04 - 08	C cassette, thick tape TC-10	(0497 - 0506) (0732 - 0858)
05 - 06	Small reel, thick tape T-20	(05A9 - 0661)
05 - 0C	C cassette, thick tape TC-20P	(0599 - 05FF) (0AA1 - 0C07)
06 - 0C	C cassette, thin tape TC-40	(0623 - 063D) (0C41 - 0CC3)
06 - 0C	C cassette, thin tape TC-30	(0611 - 0638) (0C0C - 0CB2)
07 - 08	Small reel, thick tape T-40	(07CC - 08E5)
09 - 0B	Small reel, thick tape T-60	(09FD - 0B78)
0C - 0D	Small reel, thick tape T-80(DF-160)	(0C20 - 0DFC)
0D - 0F	Small reel, thick tape T-90(DF-180)	(0D31 - 0F3E)
0E - 10	Small reel, thick tape T-100	(0E43 - 107F)
10 - 12	Small reel, thin tape T-140	(10E1 - 120C)
10 - 13	Small reel, thick tape T-120(DF-240)	(1073 - 1313)
11 - 14	Small reel, thick tape T-130	(1185 - 1429)
12 - 14	Small reel, thin tape T-160	(12D3 - 141F)
13 - 14	Small reel, thin tape T-210(DF-420)	(1373 - 14C3)
13 - 14	Small reel, thin tape T-180(DF-360)	(1357 - 14C0)
13 - 14	Small reel, thin tape T-168	(1395 - 14EE)
13 - 14	Small reel, thick tape DF-300	(13A8 - 14CE)
15 - 16	Large reel T-20	(1536 - 1618)
16 - 17	Large reel T-30	(1647 - 175A)
17 - 18	Large reel T-40	(1759 - 189C)
19 - 1B	Large reel T-60	(1989 - 1B2F)

#### Note:

- The values of cassette tape type <2> in the above table are typical values with representative cassette tapes.

### 5.3.7 EMG detail information <3>

Three deck operation modes preceding the deck operation mode in which the EMG occurs may be confirmed based on the figures in the EMG information detail <3>. For the contents of the displayed information, see the table "Deck operation mode" in section "5.3.5 EMG detail information <1>".

## 5.4 Display function of DVD section

### 5.4.1 Displaying SYSTEM INFO

SYSTEM INFO contains information on firmware version of the unit and the mechanism drive, and an initialize execution menu.

- (1) Set the unit to the Jig RCU mode.
- (2) Transmit "8b" from the JIG RCU.
- (3) SYSTEM INFORMATION menu is displayed in the screen.
- (4) To move cursor in SYSTEM INFO, use the "▲", "▼", "◀", and "▶" buttons of a remote control unit attached to product.
- (5) To quit the SYSTEM INFO menu, transmit "8b" from the JIG RCU..
- (6) Cancel JIG RCU mode.

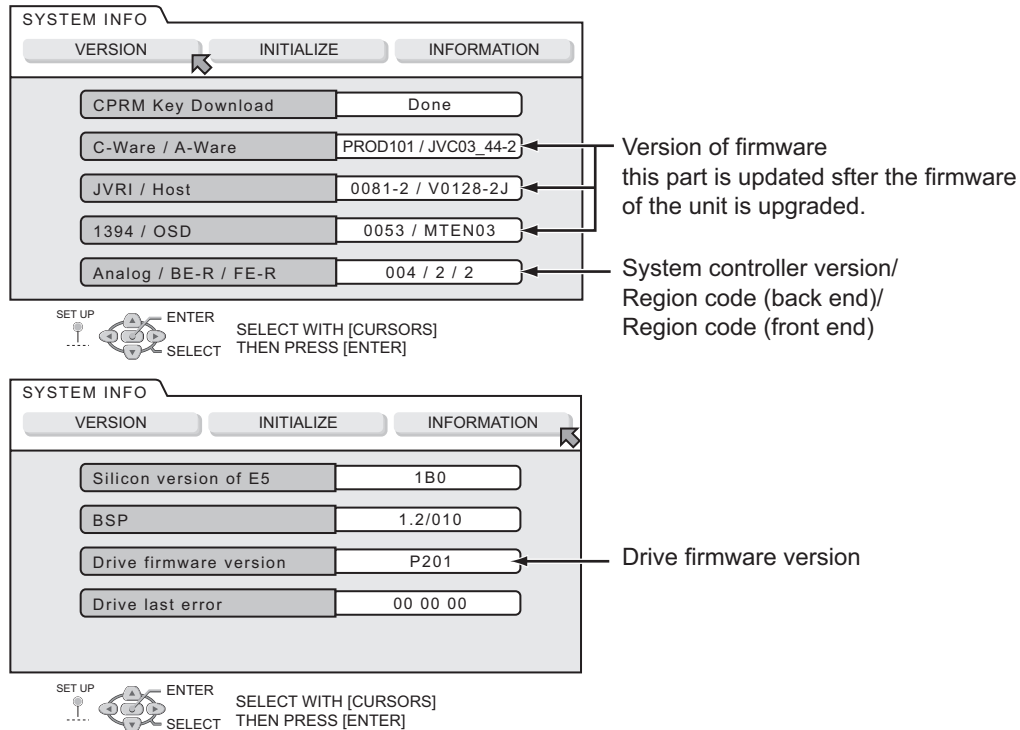

#### NOTE:

Items other than the ones described above are not used in service work.

### 5.4.2 Upgrading firmware of the unit

- Firmware upgrade disk supports only DVD-RAM media
  - When firmware needs to be upgraded, Digital Video Storage CSG will distribute a firmware upgrade disk.
- (1) Set the unit to the Jig RCU mode.
  - (2) Set the unit to DVD mode.(DVD lamp lights up)
  - (3) Transmit "70" from the JIG RCU.
  - (4) "UPDATE" appears in FDP, load the upgrade disk on the disk tray then close the disk tray.
  - (5) Wait for approx.30 seconds while FDP is displayed as "UPDATE."
  - (6) Then, "FW UPDATE" appears in FDP. It takes approx. 3 minutes at maximum to upgrade firmware.
  - (7) The tray is ejected. Then, take out the disk and close the tray.
  - (8) The tray is ejected. Then, take out the disk and close the tray.Turn off the unit, and unplug the AC power cord from the AC outlet.  
Then plug the AC power cord into the AC outlet.
  - (9) "LOADING" of FDP disappears. then, turn on the unit.
  - (10) Display the SYSTEM INFO menu, and check the version of the firmware.
  - (11) Cancel the JIG RCU mode

#### ATTENTION :

Firmware may sometimes not be upgraded successfully.

If firmware is not upgraded successfully, the tray opens, and "ERROR" appears in FDP.

If firmware is upgraded successfully, the tray opens, and "OPEN" appears in FDP.

If unplug the AC power cord from the AC outlet while "ERROR" appears, data in the flash memory is destroyed and the unit cannot start: the flash memory needs to be replaced.

After upgrading procedure, pay enough attention to FDP when the tray opens.

When "ERROR" appears, upgrade firmware again in the following way to restore the firmware

- (1) Transmit "70" from the JIG RCU while the tray opens.
- (2) When "UPDATE" appears in FDP, close the tray and make the unit read the disk. Upgrading starts.
- (3) After (2), perform upgrading procedure (4) - (10) of 5.4.2 Upgrading firmware of the unit above.

#### **5.4.3 The exchange method of a tray fitting**

When DVD unit is exchanged, please transplant a tray fitting from an old drive, or change for a new tray fitting.

#### **5.4.4 Initialization method**

Since the information on internal is as follows if it initializes, before enforcement, it is required to surely obtain the approval of a customer.

All initial setting of DVD returns to an initial state.

- (1) Set the unit to the JIG RCU mode.
- (2) Set the unit to DVD mode. (DVD lamp lights up)
- (3) Press the "POWER" button on the unit to turn off the unit.
- (4) Transmit "6F" from the JIG RCU.
- (5) Confirm the FDP changes from "FACTORY" to "CHECK OK".
- (6) Press the "VCR/DVD" button on the unit so that the VCR lamp lights up on the unit.
- (7) To cancel JIG RCU mode transmit "9D" from the JIG RCU.

#### **5.4.5 The setting method of a region code**

A region code should be set after a DVD unit is replaced.

While a DVD unit is in a warehouse as a stock, a region code of the DVD unit is not determined.

Only replacement of a DVD unit may cause abnormal playback of Disc.

Set a region code of a DVD unit in the following procedure.

- (1) Replace a DVD unit.
- (2) Set the unit to JIG RCU mode.
- (3) Insert a DVD-RAM disc in the unit to make the unit read the DVD-RAM disc. (The DVD-RAM disk used in this procedure is not a disk for upgrade. If it is a DVD-RAM disk, it is good anything.)
- (4) Transmit "F2" from the JIG RCU.
- (5) "REGION 1" is displayed on FDP.
- (6) Set the unit to STANDBY mode.
- (7) Turn the POWER switch ON.
- (8) To cancel JIG RCU mode transmit "9D" from the JIG RCU.
- (9) Colon is displayed on a clock on FL display.
- (10) Setting is completed in the procedure above.



**JVC SERVICE & ENGINEERING COMPANY OF AMERICA**  
**DIVISION OF JVC AMERICAS CORP.**

[www.jvcservice.com](http://www.jvcservice.com)(US Only)

**JVC CANADA INC.**

**Head office** : 21 Finchdene Square Scarborough, Ontario M1X 1A7

(416)293-1311

**JVC**<sup>®</sup>

(No.YD006)



Printed in Japan  
WPC



## CHARTS AND DIAGRAMS

### NOTES OF SCHEMATIC DIAGRAM

**Safety precautions**  
 The Components identified by the symbol  are critical for safety. For continued safety, replace safety critical components only with manufacturer's recommended parts.

#### 1. Units of components on the schematic diagram

Unless otherwise specified.

- 1) All resistance values are in ohm. 1/6 W, 1/8 W (refer to parts list).  
 Chip resistors are 1/16 W.  
 K: KΩ(1000Ω), M: MΩ (1000KΩ)
- 2) All capacitance values are in μF, (P: PF).
- 3) All inductance values are in μH, (m: mH).
- 4) All diodes are 1SS133, MA165 or 1N4148M (refer to parts list).

**Note: The Parts Number, value and rated voltage etc. in the Schematic Diagram are for references only. When replacing the parts, refer to the Parts List.**

#### 2. Indications of control voltage

AUX : Active at high.  
 $\overline{\text{AUX}}$  or AUX(L) : Active at low.

#### 3. Interpreting Connector indications

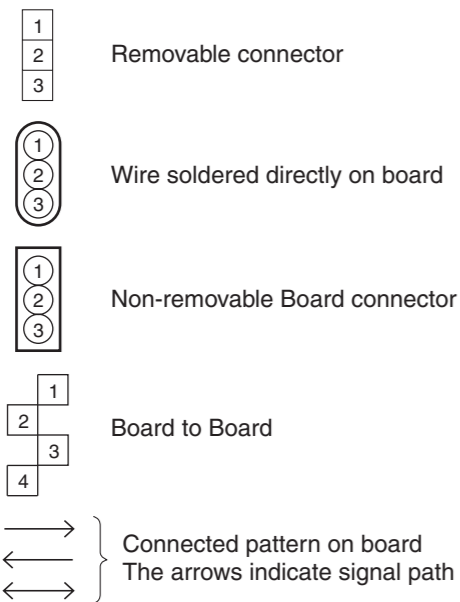

**Note: For the destination of each signal and further line connections that are cut off from the diagram, refer to "BOARD INTERCONNECTIONS"**

#### 4. Voltage measurement

- 1) Regulator (DC/DC CONV) circuits  
 REC : Colour bar signal.  
 PB : Alignment tape (Colour bar).  
 — : Unmeasurable or unnecessary to measure.
- 2) Indication on schematic diagram  
 Voltage indications for REC and PB mode on the schematic diagram are as shown below.

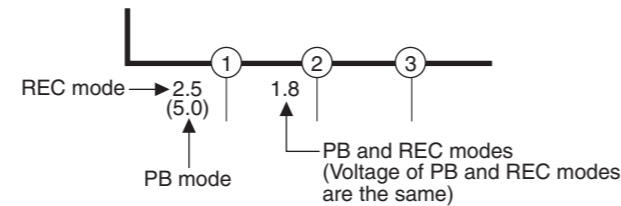

**Note: If the voltages are not indicated on the schematic diagram, refer to the voltage charts.**

#### 5. Signal path Symbols

The arrows indicate the signal path as follows.

**NOTE : The arrow is DVC unique object.**

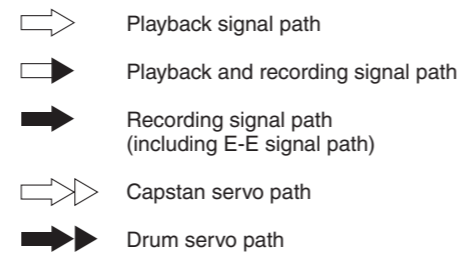

(Example)

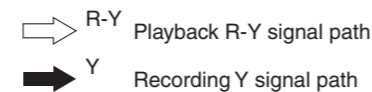

#### 6. Indication of the parts for adjustments

The parts for the adjustments are surrounded with the circle as shown below.



#### 7. Indication of the parts not mounted on the circuit board

"OPEN" is indicated by the parts not mounted on the circuit board.



### CIRCUIT BOARD NOTES

#### 1. Foil and Component sides

- 1) Foil side (B side) :  
 Parts on the foil side seen from foil face (pattern face) are indicated.
  - 2) Component side (A side) :  
 Parts on the component side seen from component face (parts face) indicated.
- Parts location are indicated by guide scale on the circuit board.

#### 2. Parts location guides

Parts location are indicated by guide scale on the circuit board.

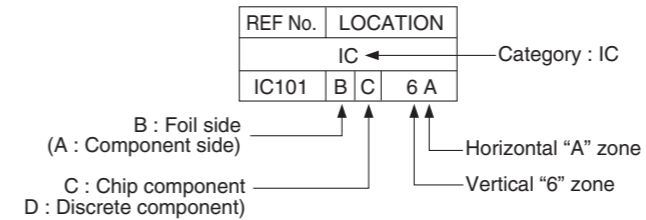

**Note: For general information in service manual, please refer to the Service Manual of GENERAL INFORMATION Edition 4 No. 82054D (January 1994).**

# BOARD INTERCONNECTIONS

5

4

3

2

1

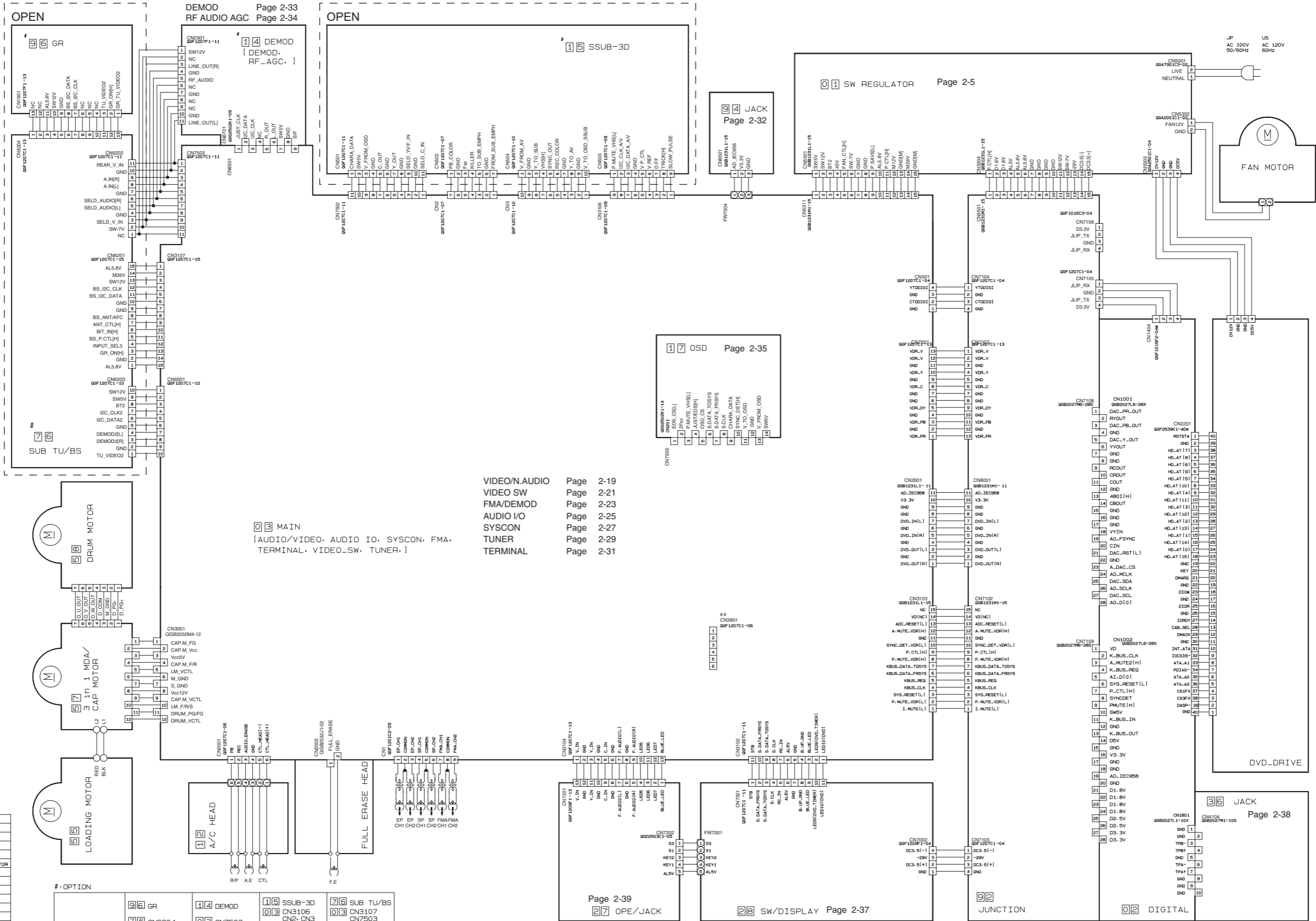

VIDEO/AUDIO Page 2-19  
 VIDEO SW Page 2-21  
 FMA/DEMOM Page 2-23  
 AUDIO I/O Page 2-25  
 SYSCON Page 2-27  
 TUNER Page 2-29  
 TERMINAL Page 2-31

MAIN  
 [AUDIO/VIDEO, AUDIO I/O, SYSCON, FMA, TERMINAL, VIDEO\_SW, TUNER.]

9 6	GR
9 2	JUNCTION
9 4	JACK
7 6	BS
5 8	DRUM MOTOR
5 7	3 In 1 MDA/CAP MOTOR
5 5	LOADING MOTOR
3 6	JACK
2 8	DISP/SW
2 7	OPR/JACK
1 7	OSD
1 5	SSUB-3D
1 4	DEMOM
1 2	A/C HEAD
0 3	MAIN
0 2	DIGITAL
0 1	SW REGULATOR
NO	NAME

# : OPTION

	9 6 GR	1 4 DEMOM	1 5 SSUB-3D	7 6 SUB TU/BS
US	VHS X	O	X	X
	SVHS X	O	O	X
BS	X	X	O	O
JP	BS/GR O	X	O	O

##: CN3901 IS USED FOR FLASH CPU

REG VIDEO	Page 2-7	VIDEO IF	Page 2-7
AUDIO AD/DA	Page 2-39	FLASH	Page 2-9
	Page 2-41	MEDIA PROCESSOR	Page 2-11
		DDR SDRAM	Page 2-13
		1394PHY	Page 2-15
		ATAPI IF	Page 2-17

# SW.REG AND JUNCTION SCHEMATIC DIAGRAMS

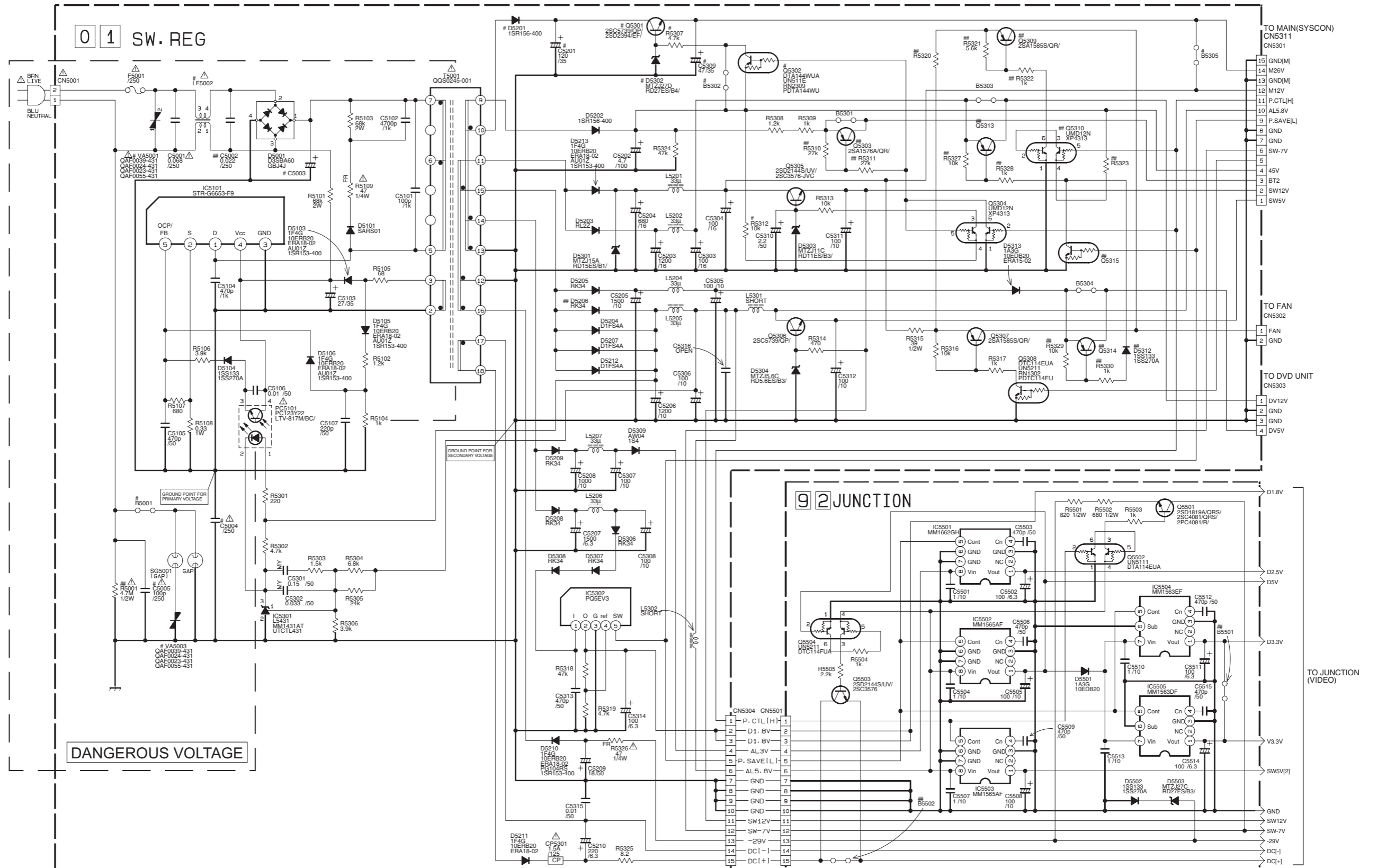

#MARK ELEMENTS ARE NOT MOUNTED.

#DIFFERENCE TABLE 1

JPN	(W/O BS)	B5001	B5302	B5305	C5003	C5004	C5005	F5001	Q5302	VA5001	HIGH SPEED FF/REW					LF5002			
		YES	NO	NO	330 /200	4700p	YES	2A	YES	YES	YES	C5201	C5309	D5201	D5302	Q5301	R5307	R5312	
EURO	NO	NO	YES	82 /400	2200p	NO	T2AL	NO	NO	NO									QGR0908-001 QGR0984-001 QGR1215-001 QGR1031-001

NOTES UNLESS OTHERWISE SPECIFIED.  
 ALL RESISTANCE VALUES ARE IN OHMS.  
 ALL INDUCTANCE VALUES ARE IN H.  
 ALL CAPACITANCE VALUES ARE IN µF.  
 + ELECTROLYTIC  
 - CERAMIC  
 MY MYLER  
 - NON POLAR

# DIGITAL(VIDEO IF) SCHEMATIC DIAGRAM

5

4

3

2

1

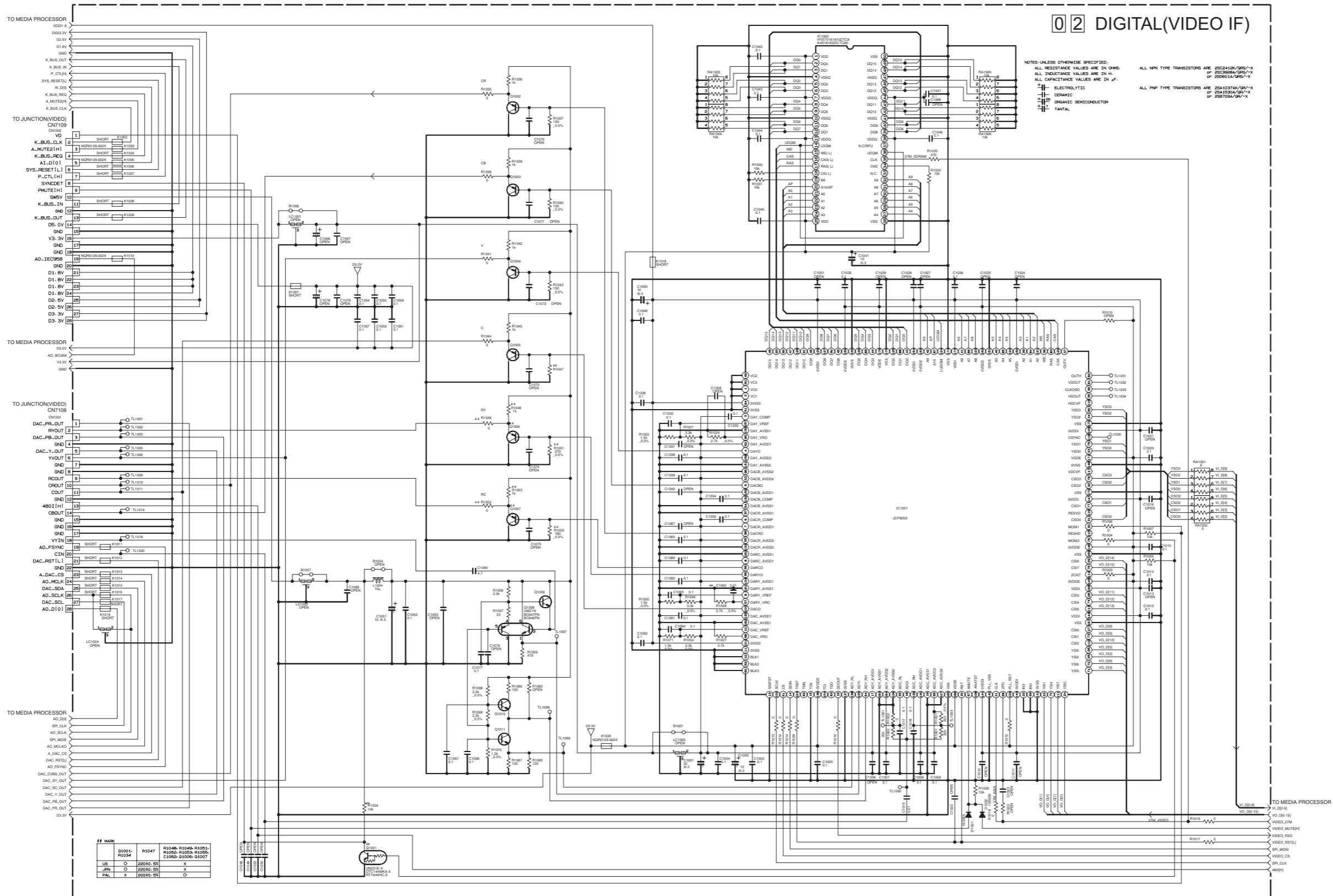

# DIGITAL(FLASH) SCHEMATIC DIAGRAM

5

4

3

2

1

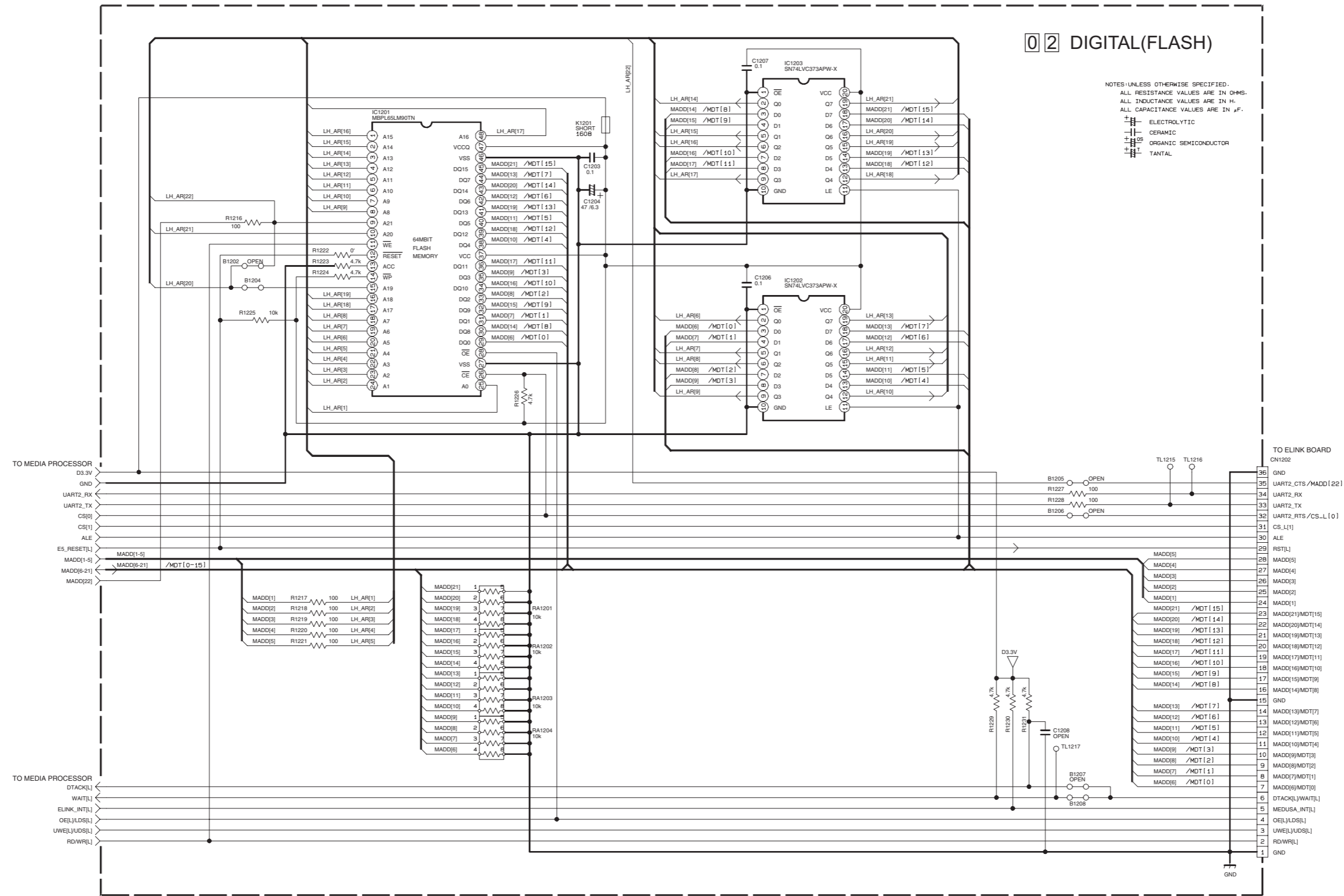

A

B

C

D

2-9

2-10

E

F

G

# DIGITAL(MEDIA PROCESSOR) SCHEMATIC DIAGRAM

5

4

3

2

1

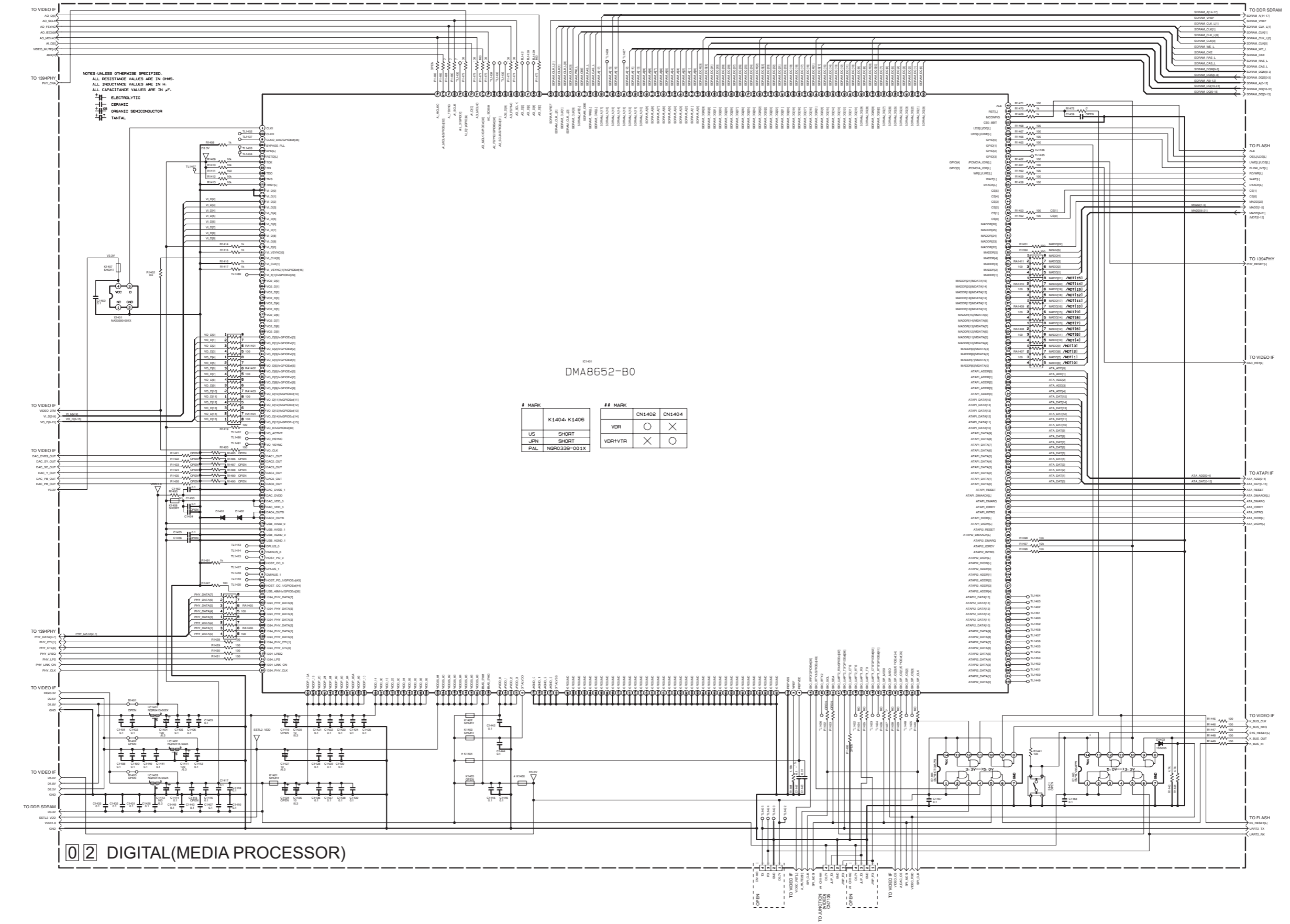

02 DIGITAL(MEDIA PROCESSOR)

# MARK	DESCRIPTION	# MARK	DESCRIPTION
US	SHORT	VDR	○
JPN	SHORT	VDR+VTR	×
PAL	NGR0339-001X		

# DIGITAL(DDR SDRAM) SCHEMATIC DIAGRAM

02 DIGITAL(DDR SDRAM)

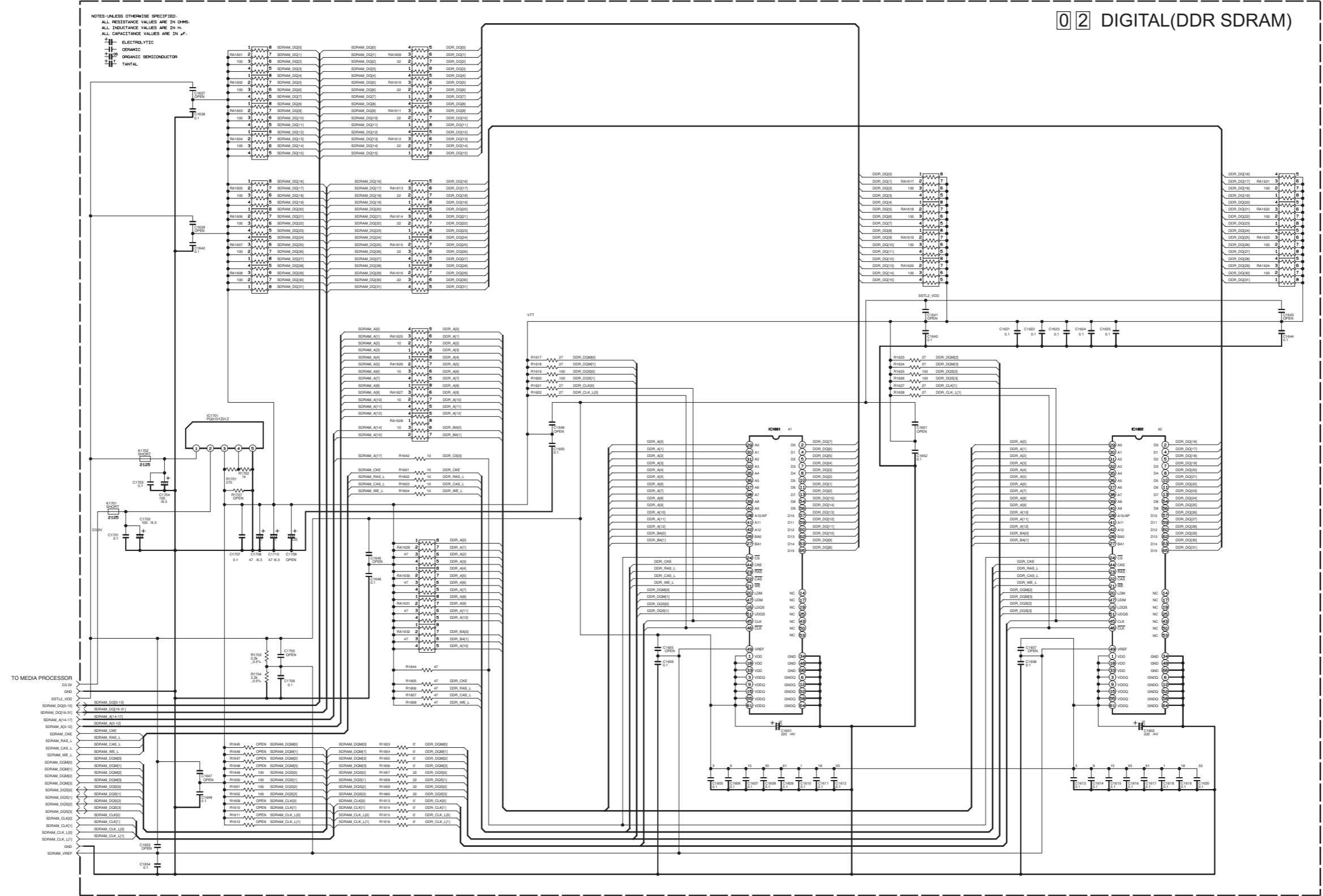

5  
4  
3  
2  
1

A B C D 2-13 2-14 E F G

■ DIGITAL(1394PHY) SCHEMATIC DIAGRAM

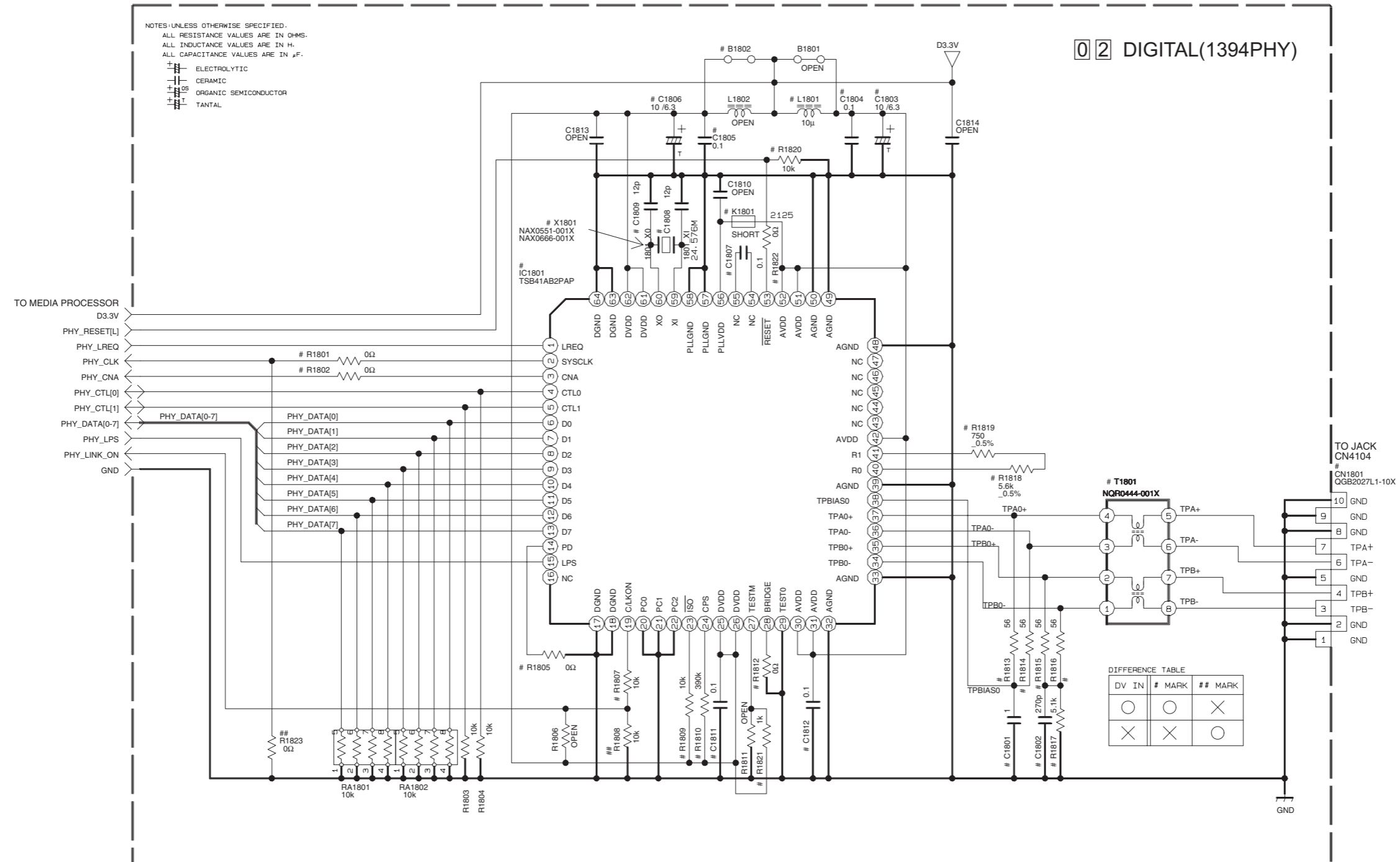



**DIGITAL(ATAPI IF) SCHEMATIC DIAGRAM**

**02 DIGITAL(ATAPI IF)**

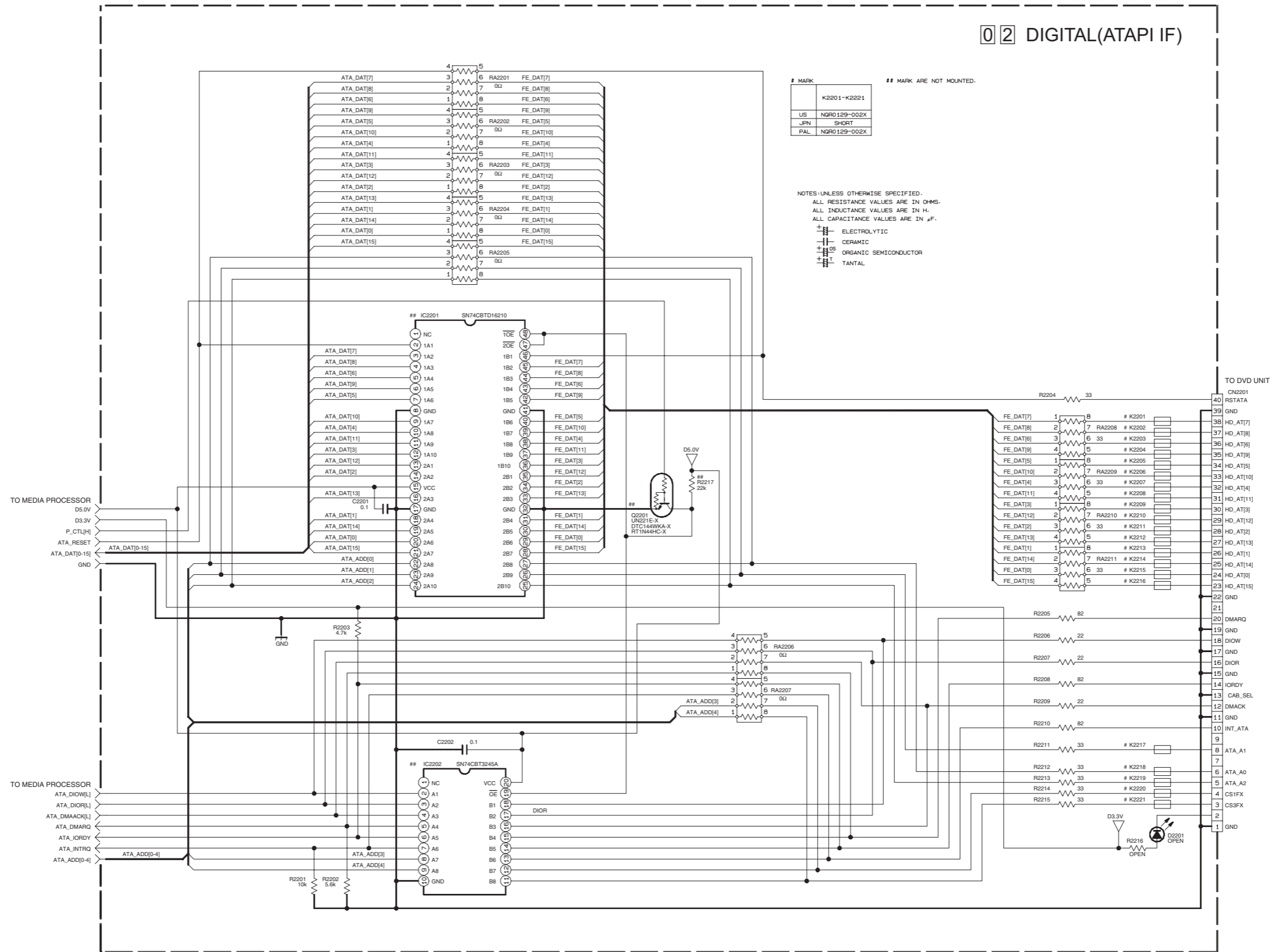

5

4

3

2

1

A

B

C

2-17

2-18

E

F

G

# MAIN(VIDEO/N.AUDIO) SCHEMATIC DIAGRAM

03 MAIN(VIDEO/N. AUDIO)

5

4

3

2

1

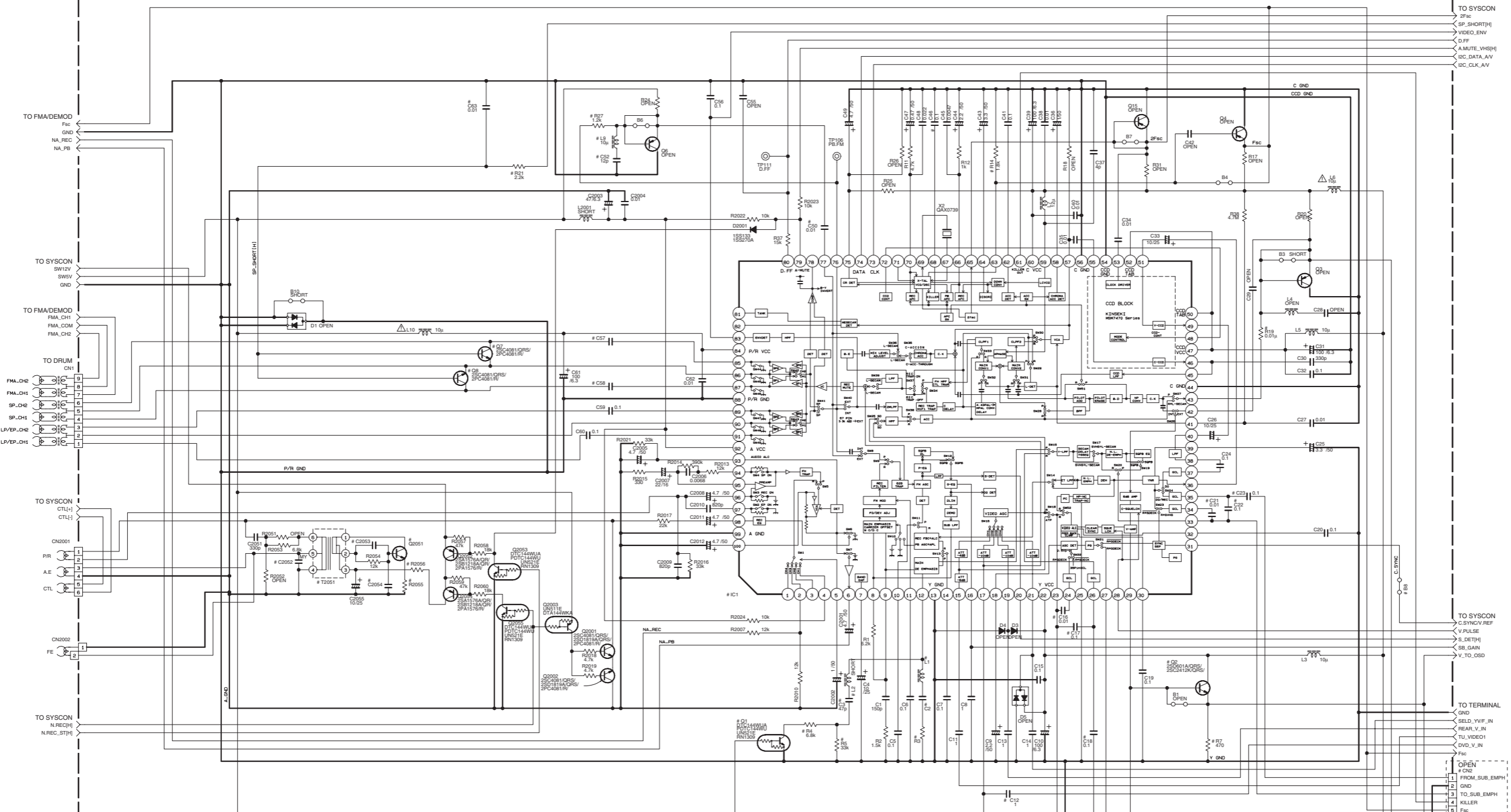

# DIFFERENCE TABLE

IC1	Q1	R3	R4-R5 C3-L2	C2	L1	C16-C18 C21-C23	C12-C17 C24-B6	Q2-R7	R27-L2 C50-C52	R19	CHD.CH3
VHS	JCPB060-NYA	X	8.2k	X	330	X	O	O	X	X	X
S-VHS	JCPB060-NSA	O	120	O	4p	100*	O	X	O	O	O

	Q2, Q6 R21, C63	C57-C58	T2051	Q2051	R2055	R2056	C2052	C2053	C2054	
WITH SEP	O	0.01	JP	69R1197-001A	29C4097/GR/	4.7	47	0.047	0.0033	0.0068
W/O SEP	X	0.1	US	PELNB32	29C4091/GRB/	3.3	82	0.082	0.0047	0.002

NOTES: UNLESS OTHERWISE SPECIFIED,  
 ALL RESISTANCE VALUES ARE IN OHMS.  
 ALL INDUCTANCE VALUES ARE IN H.  
 ALL CAPACITANCE VALUES ARE IN μF.

ELECTROLYTIC  
 CERAMIC  
 MYLAR  
 NON POLAR

TO SYSCON  
 2Fsc  
 SP\_SHORT[H]  
 VIDEO\_ENV  
 D.FF  
 A.MUTE\_VHS[H]  
 C.C. DATA\_AV  
 C.C. CLK\_AV

TO SYSCON  
 C.SYNCV\_REF  
 V.PULSE  
 S.DETH[H]  
 SB\_GAIN  
 V.TO\_OSD

TO TERMINAL  
 GND  
 SELD\_YV\_IN  
 REAR\_V\_IN  
 TU\_VIDEO1  
 DVD\_V\_IN  
 Fsc  
 GND  
 PB\_COLOR  
 OPEN  
 #C21  
 V.TO\_OSD\_SSUB  
 GND  
 V.TO\_AV  
 GND  
 REC\_COLOR  
 SYNC\_OUT  
 VHS[H]  
 Y.TO\_SUB  
 GND  
 V.FROM\_AV  
 GND

# MAIN(VIDEO SW) SCHEMATIC DIAGRAM

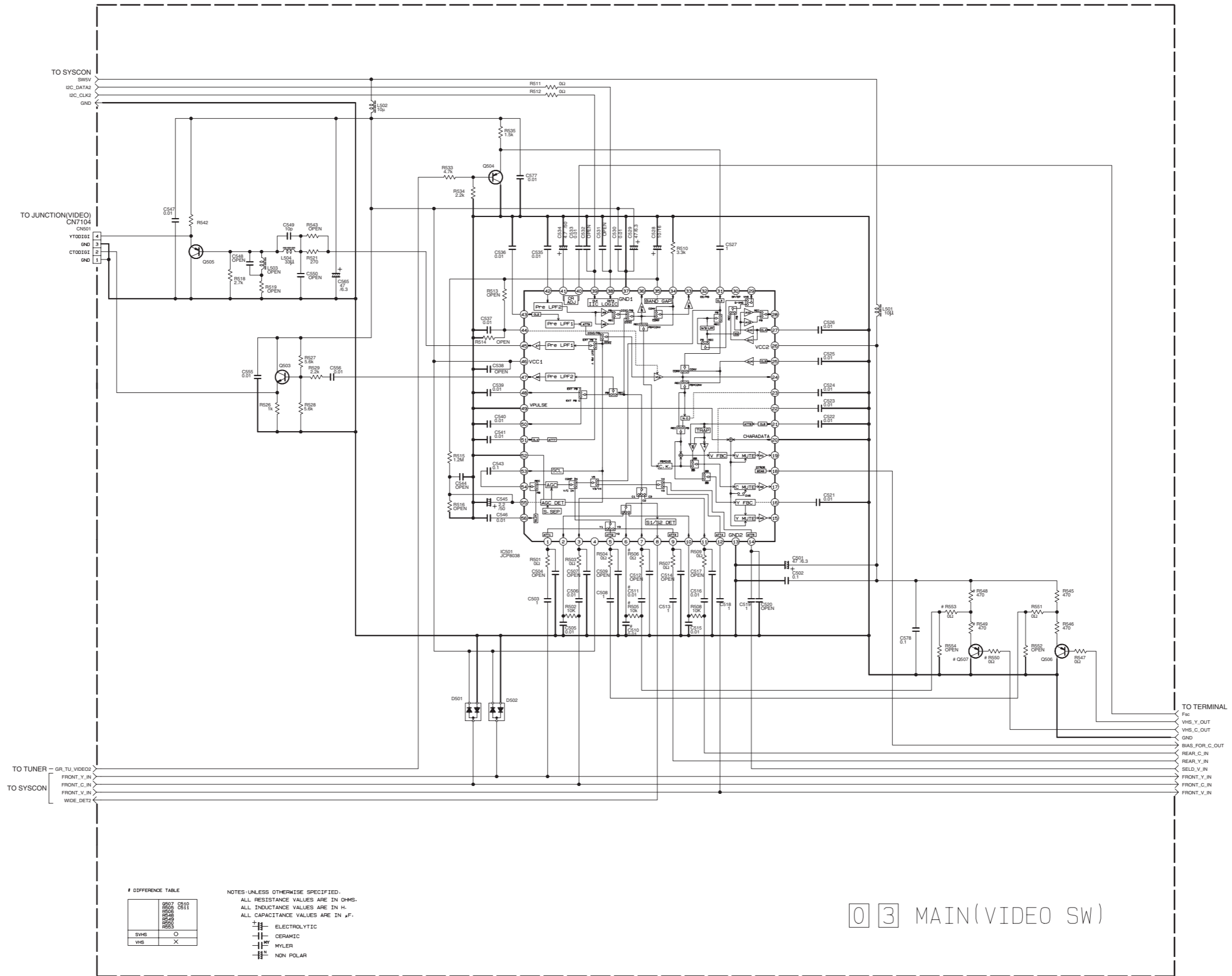

# DIFFERENCE TABLE

SWHS	O	CS10
WHS	X	CS11

NOTES: UNLESS OTHERWISE SPECIFIED.  
 ALL RESISTANCE VALUES ARE IN OHMS.  
 ALL INDUCTANCE VALUES ARE IN H.  
 ALL CAPACITANCE VALUES ARE IN  $\mu$ F.

- ELECTROLYTIC
- CERAMIC
- MYLER
- NON POLAR

03 MAIN(VIDEO SW)

■ MAIN(FMA/DEMOD) SCHEMATIC DIAGRAM

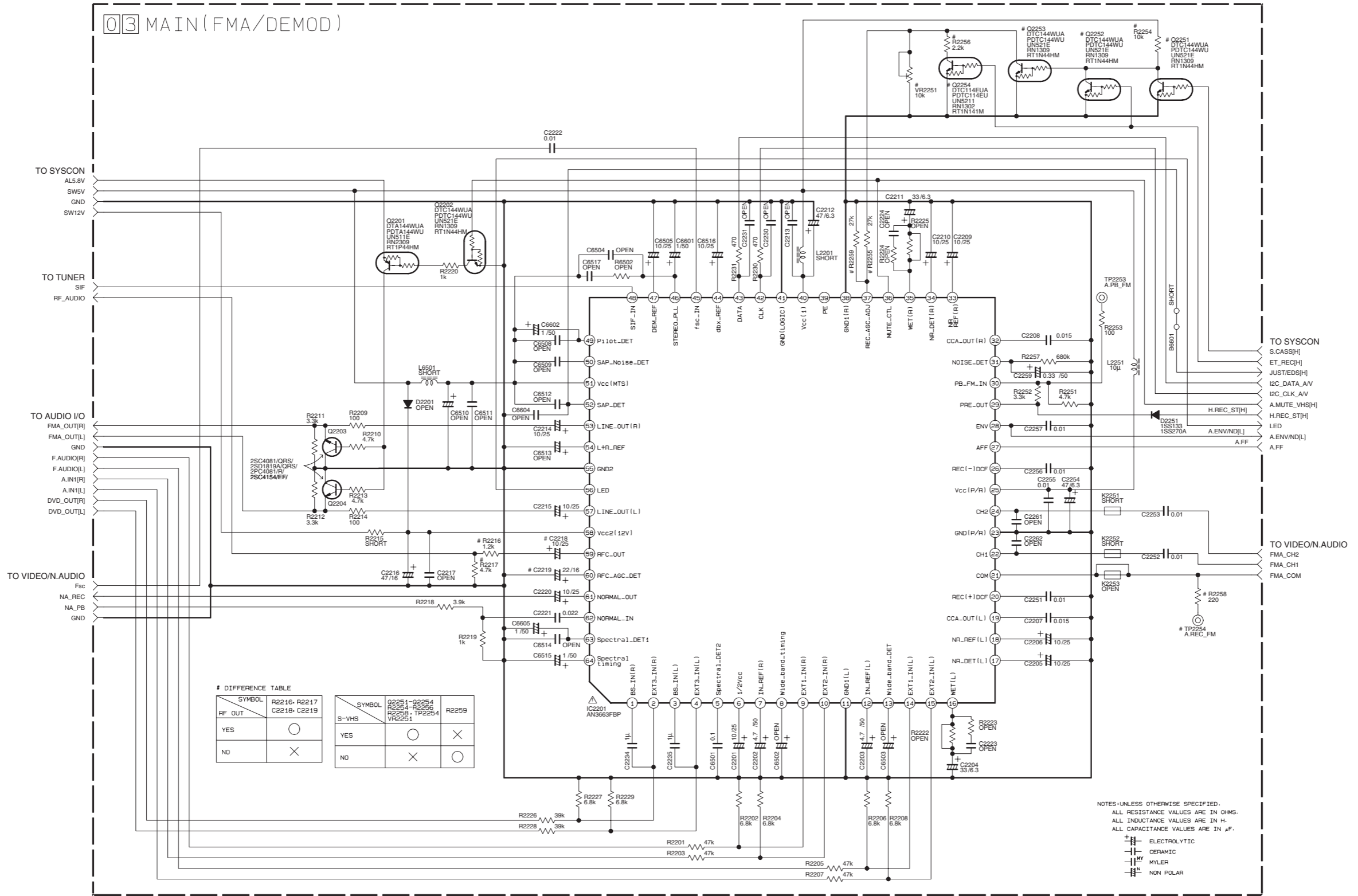

# MAIN(AUDIO I/O) SCHEMATIC DIAGRAM

5  
4  
3  
2  
1

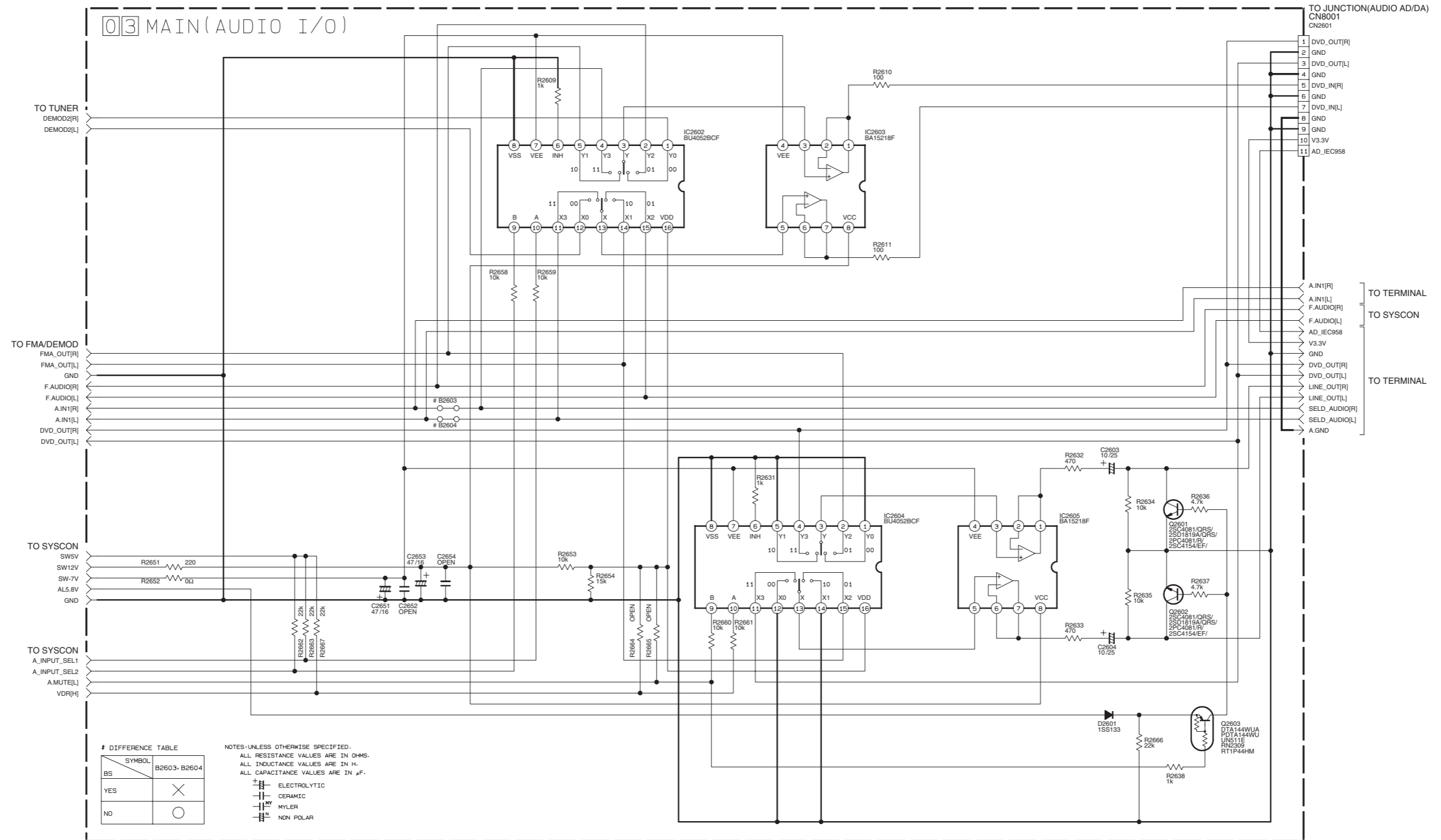

A B C D 2-25 2-26 E F G



# MAIN(TUNER) SCHEMATIC DIAGRAM

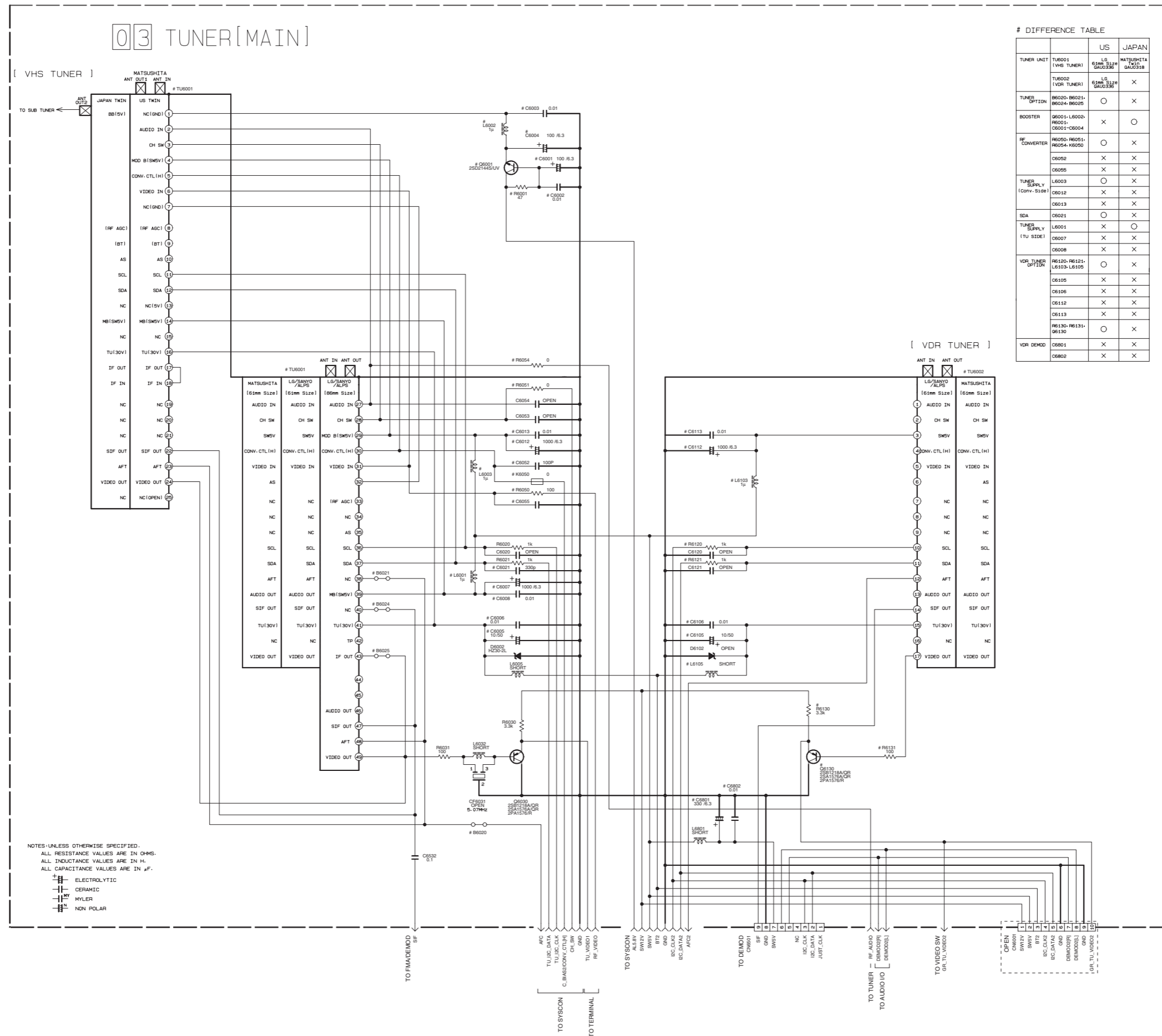

# DIFFERENCE TABLE

	US	JAPAN
TUNER UNIT	TU6001 (VHS TUNER)	MATSUSHITA TU6002 (VDR TUNER)
TUNER OPTION	R6020-R6021-R6024-R6025	R6120-R6121-R6124-R6125
BOOSTER	Q6001-L6002-R6001-C6004	Q6101-L6102-R6101-C6104
RF CONVERTER	R6050-R6051-R6054-K6050	R6150-R6151-R6154-K6150
TUNER SUPPLY (conv. side)	L6003	L6103
SEA	C6021	C6121
TUNER SUPPLY (TU SIDE)	L6001	L6101
VDR TUNER OPTION	R6120-R6121-L6103-L6105	R6020-R6021-L6003-L6005
VDR DEMOD	C6801	C6802

NOTES UNLESS OTHERWISE SPECIFIED:  
 ALL RESISTANCE VALUES ARE IN OHMS.  
 ALL INDUCTANCE VALUES ARE IN H.  
 ALL CAPACITANCE VALUES ARE IN pF.  
 + ELECTROLYTIC  
 - CERAMIC  
 - MYLER  
 - NON POLAR

# MAIN(TERMINAL) AND JACK SCHEMATIC DIAGRAMS

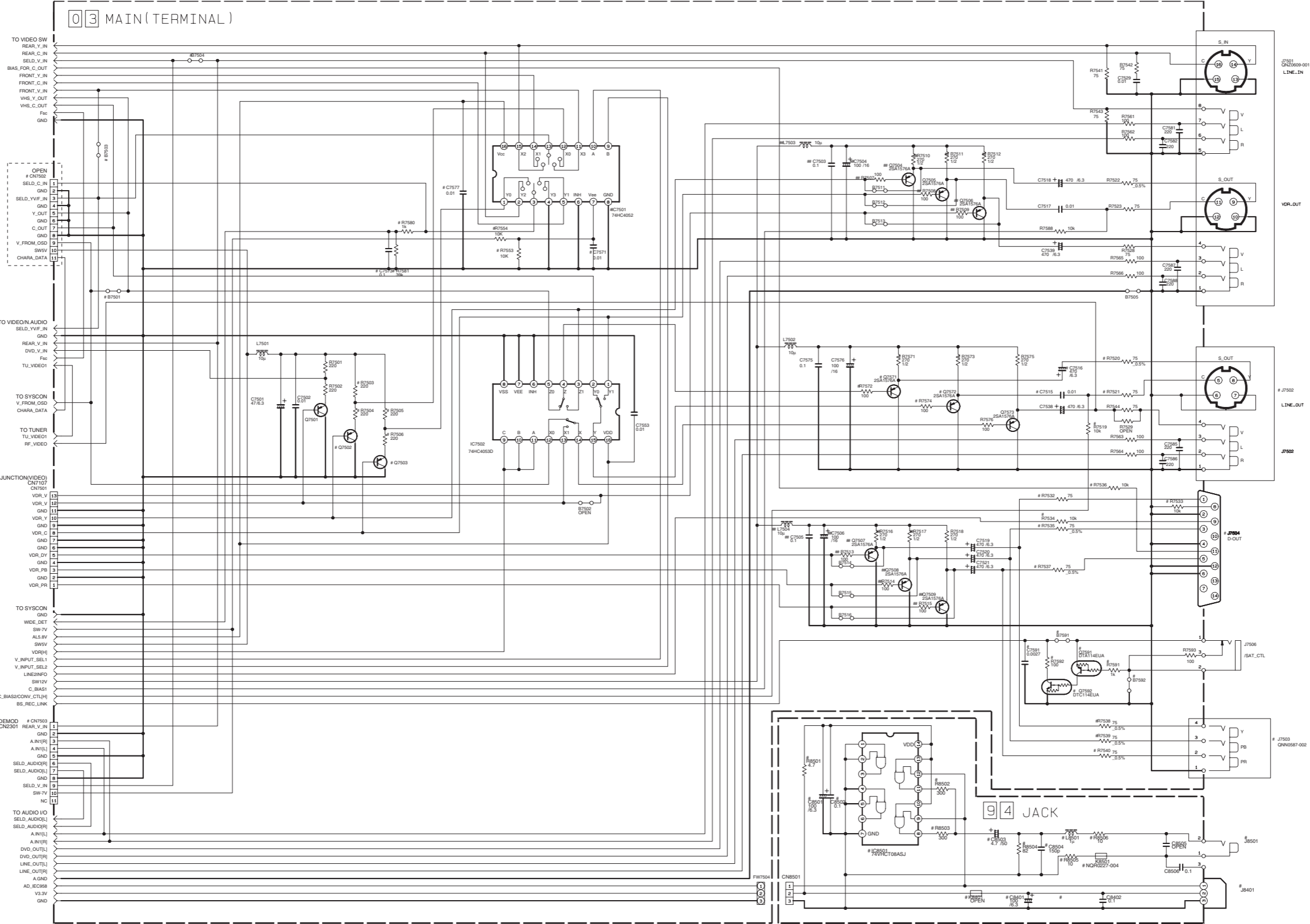

## MARKED PARTS ARE NOT MOUNTED

# DIFFERENCE TABLE

	J7504	R7536	J7503
DOMESTIC MODEL	○	○	×
US MODEL	×	○	○

	IC7501	R7503	R7502	C7512	B7501	J7502
S/PB	○	○	○	○	○	○
WB	○	×	○	○	○	○

	CN7503	B7504
w/ BS	○	×
w/o BS	×	○

	Q7501	Q7502	B7504
BS DIGITAL LINK REC	○	○	×
REMOTE PAUSE	×	○	○

	J8401	IC8001	R8506	L8501
OPT OUT	○	○	○	○
CDAXIAL OUT	×	○	○	○

NOTES-UNLESS OTHERWISE SPECIFIED:  
 ALL RESISTANCE VALUES ARE IN OHMS.  
 ALL INDUCTANCE VALUES ARE IN H.  
 ALL CAPACITANCE VALUES ARE IN μF.

- ⊕ ELECTROLYTIC
- ⊖ CERAMIC
- ⊖ MYLER
- ⊖ NON POLAR

5

4

3

2

1

A

B

C

2-31 D

2-32 E

F

G



■ DEMOD SCHEMATIC DIAGRAM

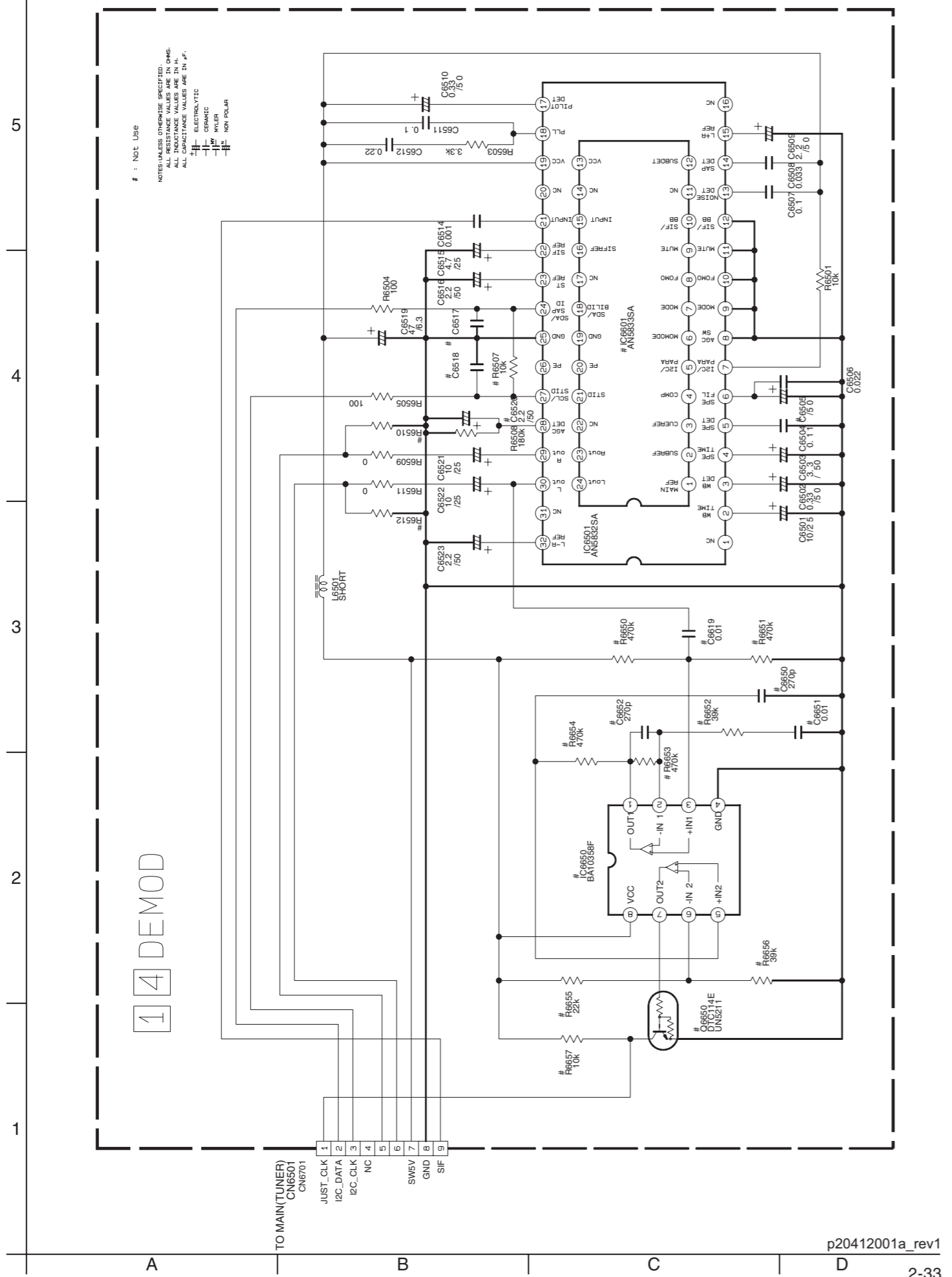

■ DEMOD(RF AUDIO AGC) SCHEMATIC DIAGRAM

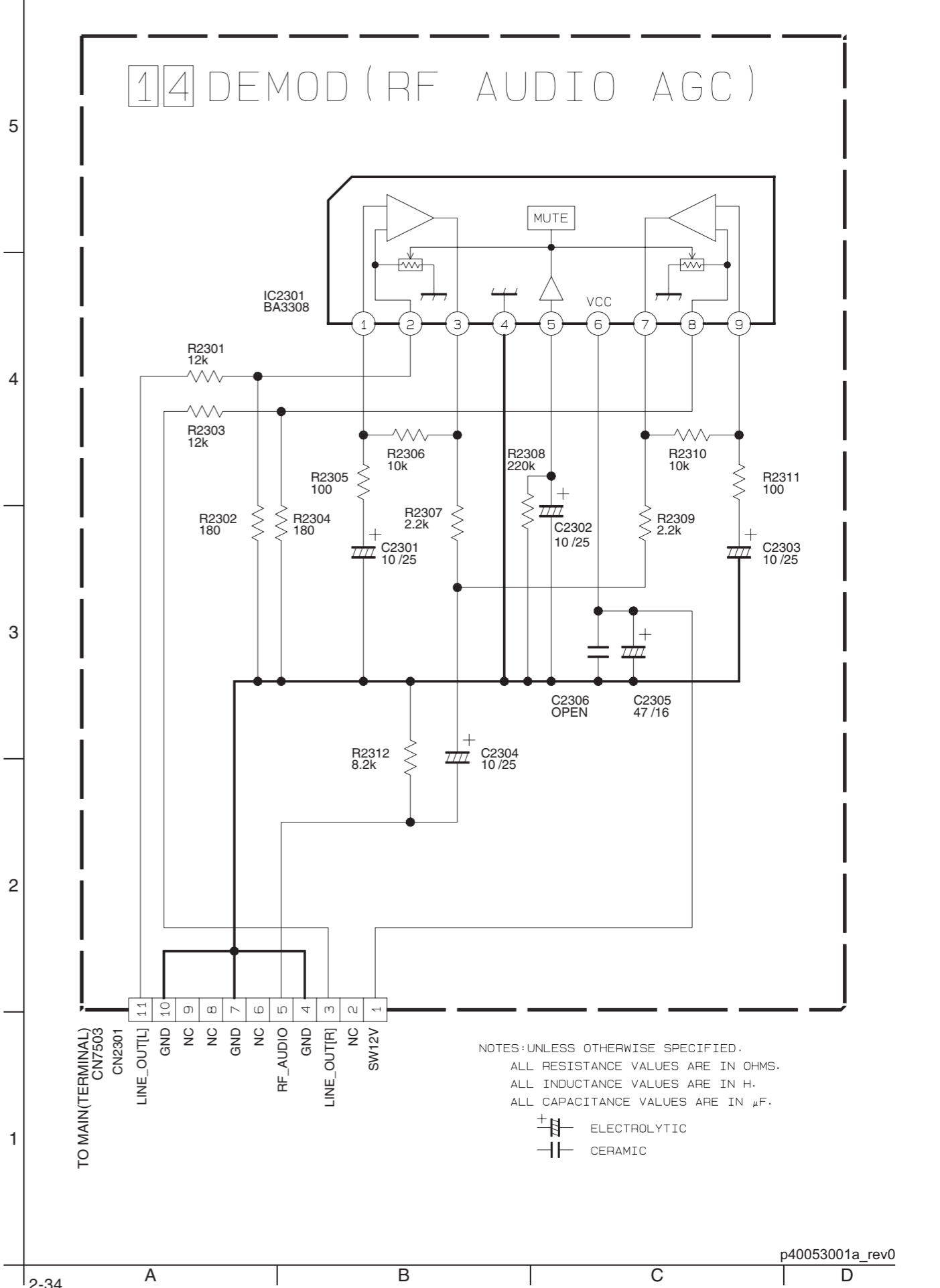

ON SCREEN SCHEMATIC DIAGRAM

17 ON SCREEN

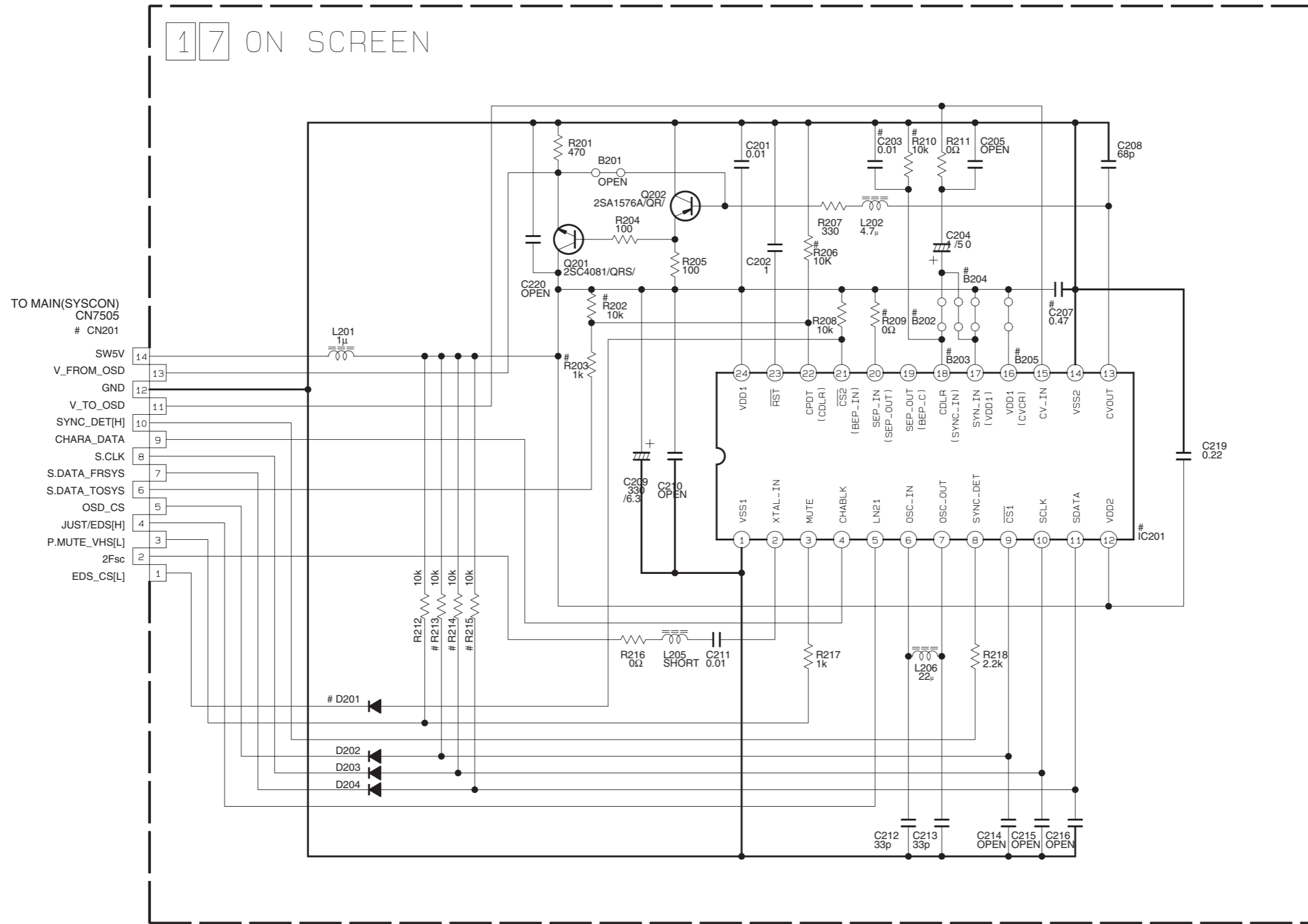

# DIFFERENCE TABLE

	IC201	D201	R202, R203 R209, R210	R206, R213 R214, R215	C203	C207	B202 B204	B203 B205	CN201
DOM	LC74789N	X	X	O	X	O	O	X	2-14
US	LC74785N	O	O	X	O	X	X	O	1-14

NOTES: UNLESS OTHERWISE SPECIFIED,  
ALL RESISTANCE VALUES ARE IN OHMS.  
ALL INDUCTANCE VALUES ARE IN H.  
ALL CAPACITANCE VALUES ARE IN μF.

- ELECTROLYTIC
- CERAMIC
- MYLER
- NON POLAR

■ OPERATION JACK, SWITCH DISPLAY AND JACK SCHEMATIC DIAGRAM

5  
4  
3  
2  
1

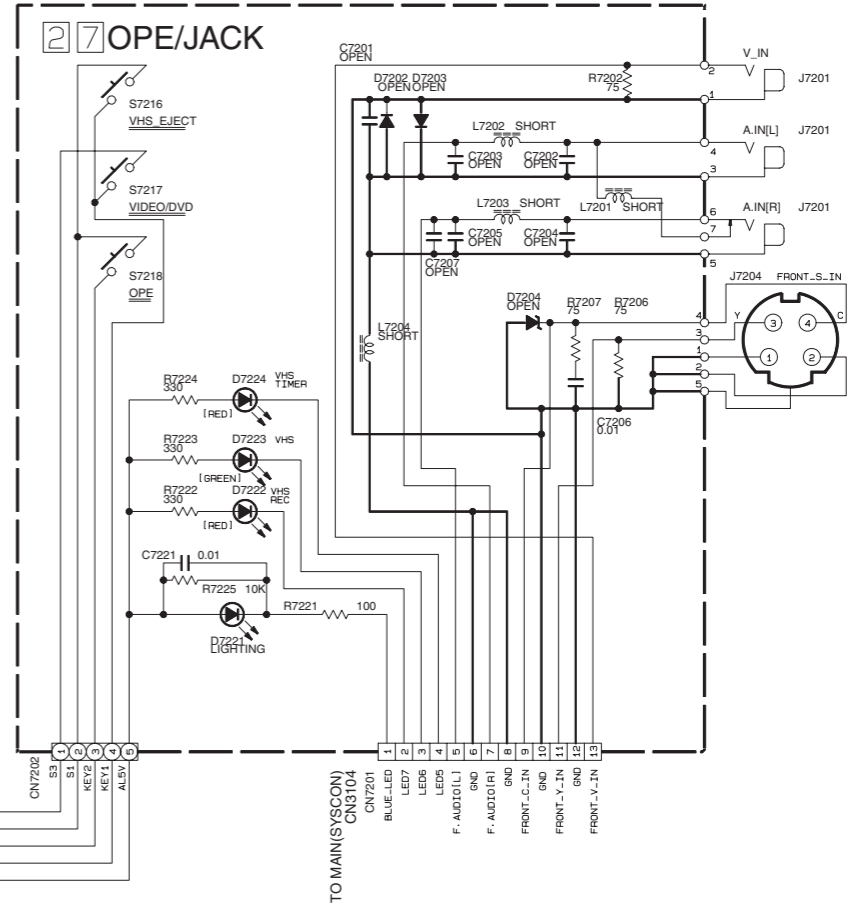
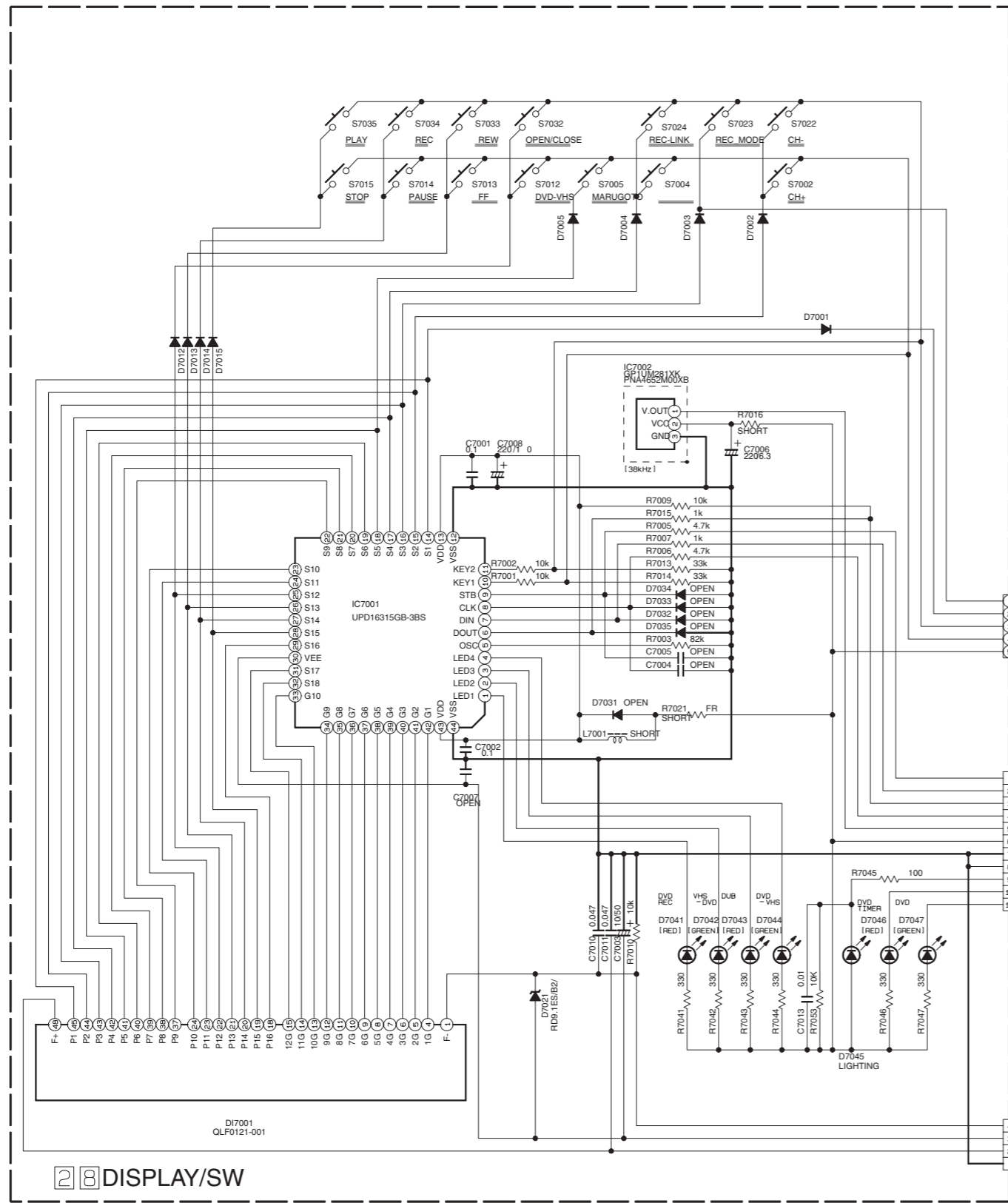

NOTES: UNLESS OTHERWISE SPECIFIED,  
ALL RESISTANCE VALUES ARE IN OHMS.  
ALL INDUCTANCE VALUES ARE IN H.  
ALL CAPACITANCE VALUES ARE IN μF.

ELECTROLYTIC  
 CERAMIC  
 MYLER  
 NON POLAR

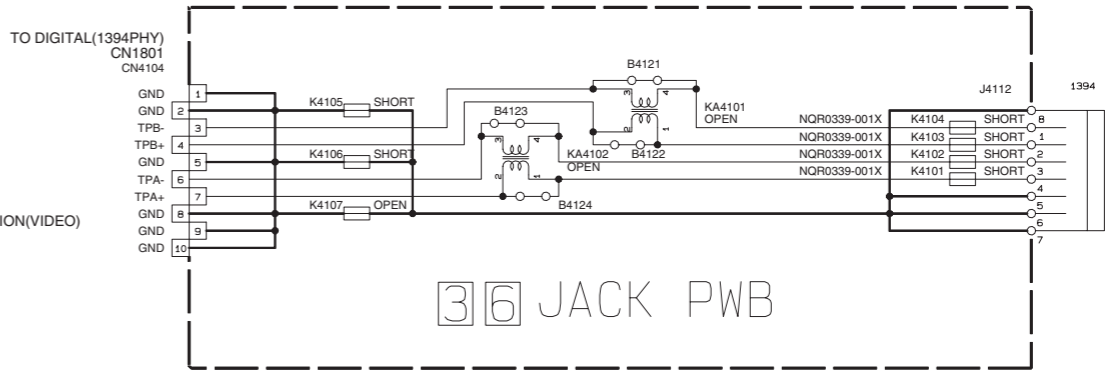

A B C D 2-37 E F G

# VIDEO(JUNCTION) SCHEMATIC DIAGRAM

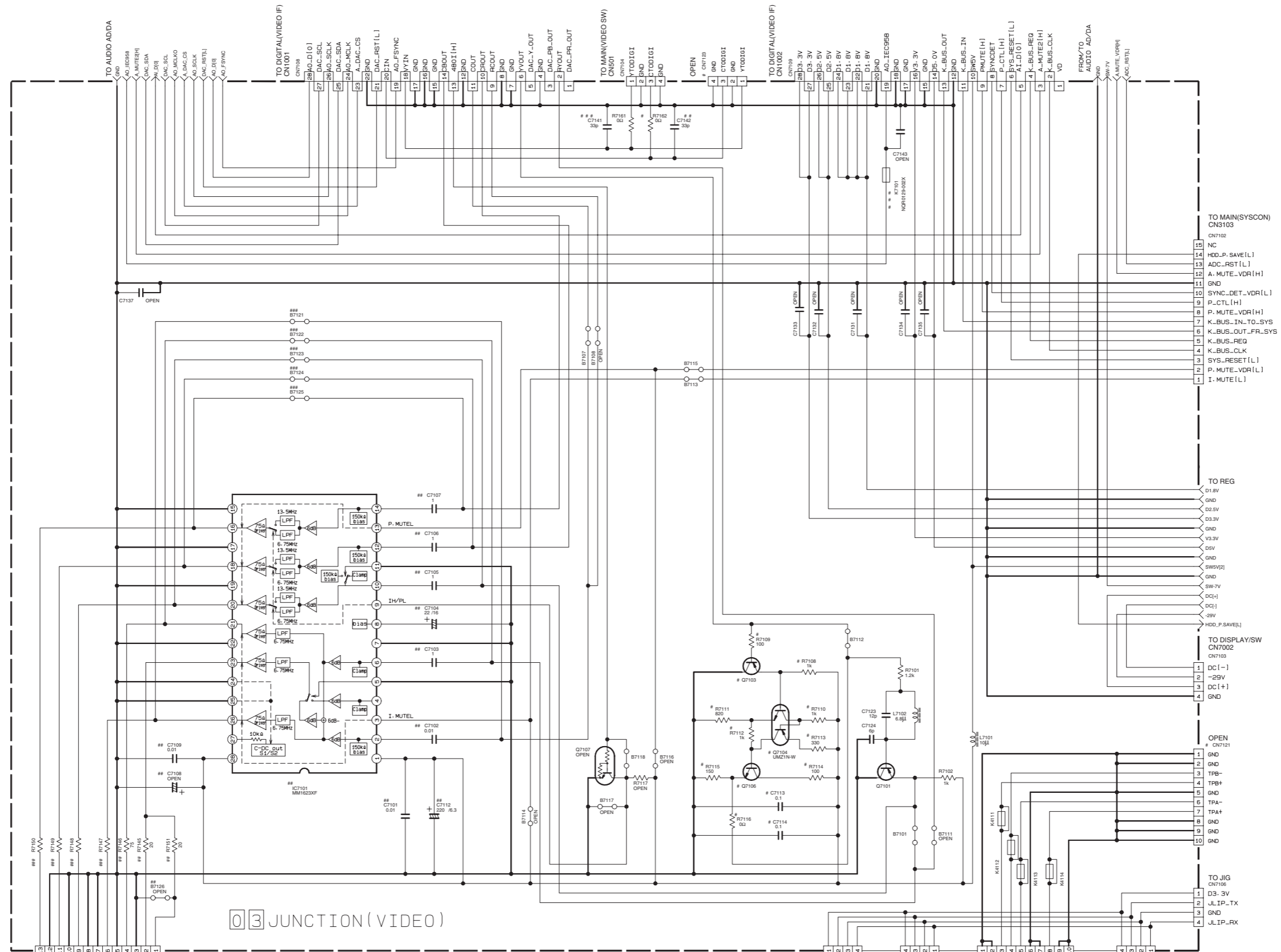

03 JUNCTION (VIDEO)

DIFFERENCE TABLE [ #.#.#.# SYMBOLS ]

#.#.#.# SYMBOLS	B7121-B7125	R7147	R7148-R7150	K7101	C7141
DOM	X	75	20	SHORT	X
PAL	X	0a	0a	SHORT	X
US	X	75	20	NR0129-002X	O

# MARK ARE NOT MOUNTED

NOTES-UNLESS OTHERWISE SPECIFIED.  
 ALL RESISTANCE VALUES ARE IN OHMS.  
 ALL INDUCTANCE VALUES ARE IN H.  
 ALL CAPACITANCE VALUES ARE IN μF.

⊕ ELECTROLYTIC  
 — CERAMIC  
 — MYLAR  
 — NON POLAR

# JUNCTION(AUDIO AD/DA) SCHEMATIC DIAGRAM

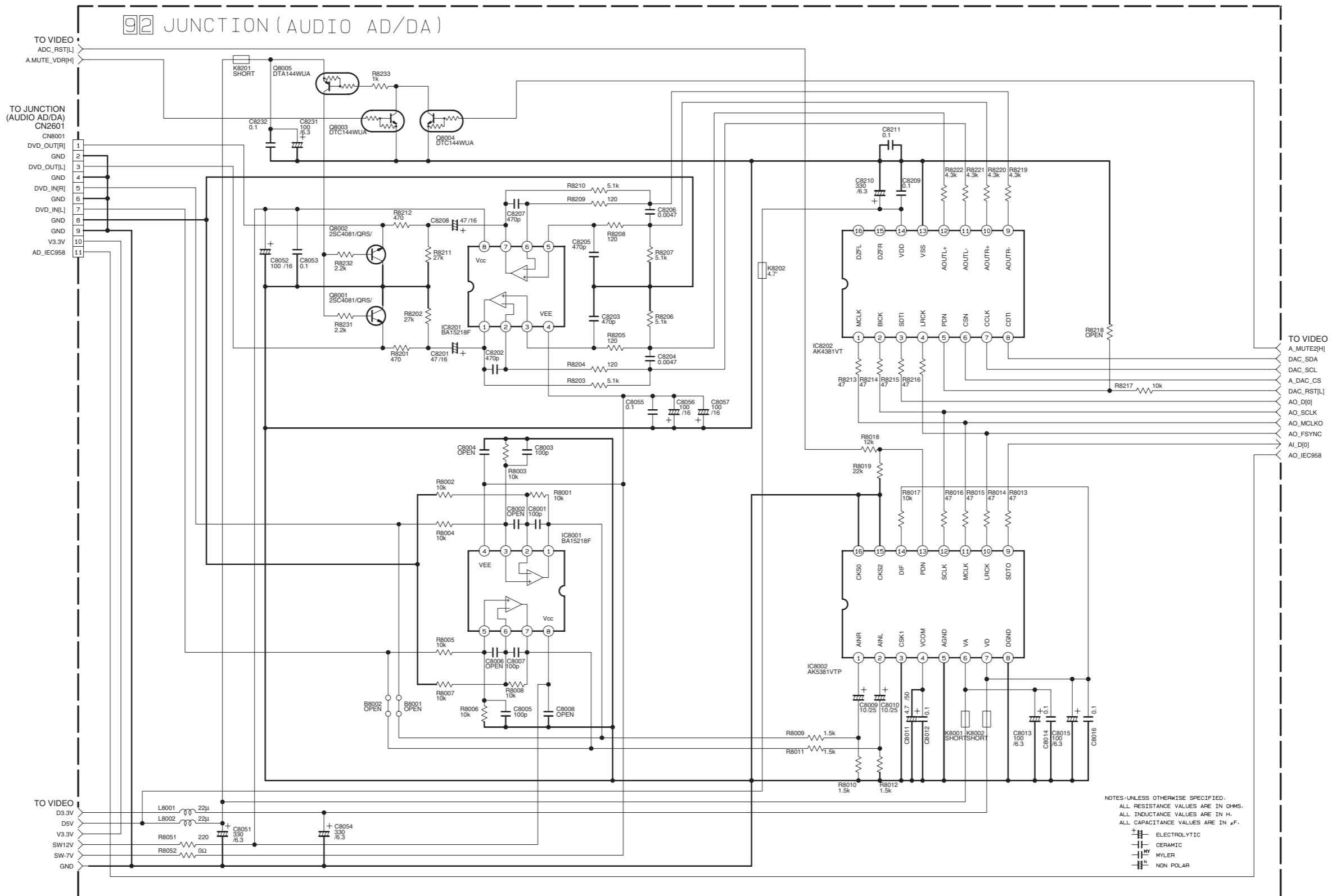



■ JACK, DEMOD, OSD, OPERATION JACK, SWITCH DISPLAY AND JACK CIRCUIT BOARDS

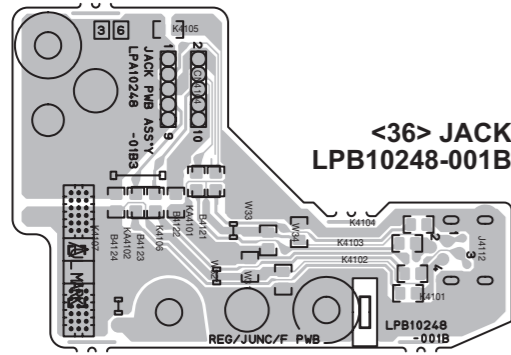

<36> JACK  
LPB10248-001B

<27> OPERATION JACK  
LPB10248-001B

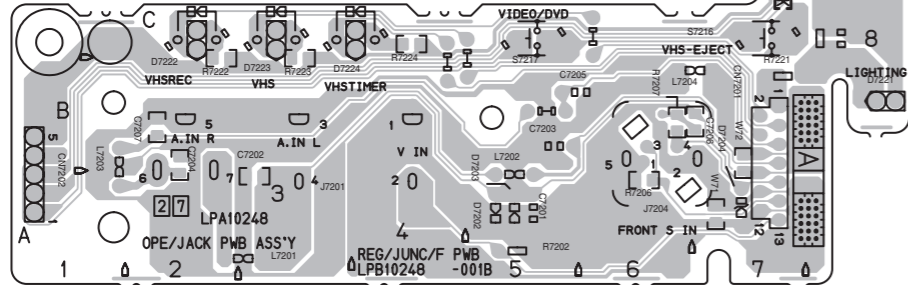

<14> DEMOD  
LPB10243-001C

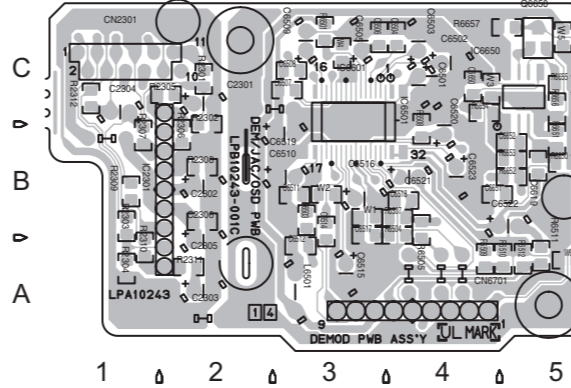

<17> OSD  
LPB10243-001C

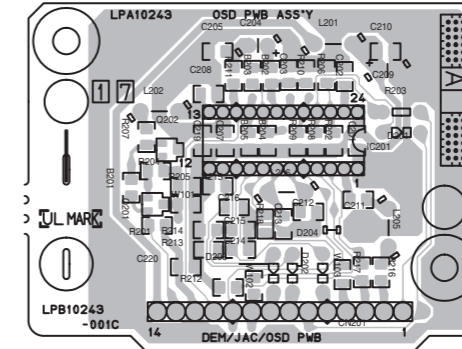

<94> JACK  
LPB10243-001C

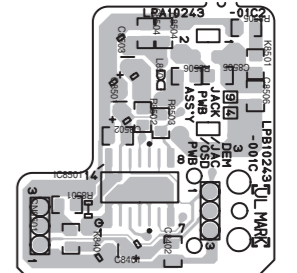

COMPONENT PARTS LOCATION GUIDE <DEMOM> LPB10243-001C

REF.NO.	LOCATION	REF.NO.	LOCATION	REF.NO.	LOCATION	REF.NO.	LOCATION	REF.NO.	LOCATION
<b>CAPACITOR</b>									
C2301	A D 2C	C6508	B C 3C	C6523	A D 4B	IC6650	B C 5C	R2312	B C 1C
C2302	A D 2B	C6510	A D 3C	C6619	B C 5B			R6501	B C 3C
C2303	A D 2A	C6511	B C 3B	C6650	B C 4C	<b>RESISTOR</b>			
C2304	A D 1C	C6512	B C 3A	C6651	B C 4B	R2301	B C 2C	R6503	B C 3B
C2305	A D 2A	C6514	B C 3B	C6652	B C 5B	R2302	B C 2B	R6504	B C 4B
C2306	B C 2B	C6515	A D 3A			R2303	B C 1B	R6505	B C 4B
C6501	A D 4C	C6516	A D 3A	<b>CONNECTOR</b>				R2304	B C 1A
C6502	A D 4C	C6517	B C 3B	CN2301	A D 1C	R2305	B C 2C	R6508	B C 4B
C6503	A D 4C	C6518	B C 4B	CN6701	A D 4A	R2306	B C 2B	R6509	B C 4A
C6504	B C 4C	C6519	A D 3B			R2307	B C 1B	R6510	B C 5A
C6505	A D 3C	C6520	A D 4B	<b>IC</b>				R6511	B C 5A
C6506	B C 3C	C6521	A D 4B	IC2301	A D 2C	R2308	B C 2B	R6512	B C 5A
C6507	B C 3C	C6522	A D 4B	IC6501	B C 3C	R2309	B C 1B	R6650	B C 5B
				IC6601	B C 3C	R2310	B C 1A	R6651	B C 5B
						R2311	B C 2A	R6652	B C 5B
								<b>COIL</b>	
								L6501	A D 3A
								<b>TRANSISTOR</b>	
								Q6650	B C 5C
								<b>OTHER</b>	
								PC044	B C 12P

<28> SWITCH DISPLAY  
LPB10248-001B

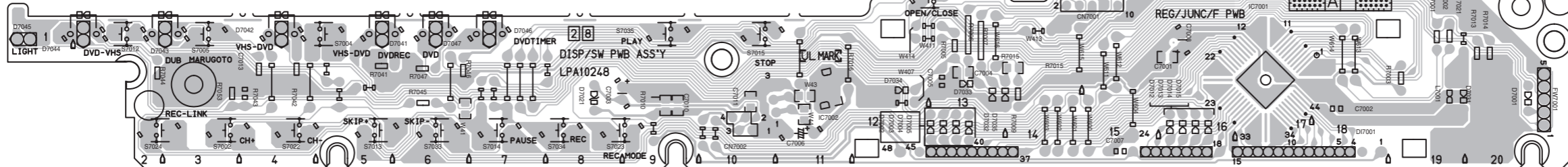

COMPONENT PARTS LOCATION GUIDE <OPERATION JACK> LPB10248-001B

REF.NO.	LOCATION	REF.NO.	LOCATION	REF.NO.	LOCATION	REF.NO.	LOCATION	REF.NO.	LOCATION
<b>CAPACITOR</b>									
C7201	A D 5A			D7221	A D 8B	L7204	A D 7B	R7224	B C 4C
C7202	B C 3A	<b>CONNECTOR</b>				D7222	A D 2C	R7225	A D 8C
C7203	A D 5B	CN7201	A D 7B	D7223	A D 3C				
C7204	B C 2B	CN7202	A D 1A	D7224	A D 4C	<b>RESISTOR</b>			
C7205	A D 5B					R7202	A D 5A	<b>OTHER</b>	
C7206	B C 7B					R7206	B C 6A	J7201	A D 3B
C7207	B C 2B					R7207	B C 6B	J7204	A D 6B
C7221	A D 8C					R7221	A D 7B	S7216	A D 7C
						R7222	B C 2B	S7217	A D 5C
						R7223	B C 3B	S7218	A D 7D

COMPONENT PARTS LOCATION GUIDE <SWITCH DISPLAY> LPB10248-001B

REF.NO.	LOCATION	REF.NO.	LOCATION	REF.NO.	LOCATION	REF.NO.	LOCATION	REF.NO.	LOCATION
<b>CAPACITOR</b>									
C7001	B C 16B			D7015	A D 16A	D7047	A D 6B	R7005	A D 13B
C7002	A D 18A	<b>CONNECTOR</b>				D7021	A D 8B	R7006	A D 13B
C7003	A D 9B	CN7001	A D 14C	D7031	A D 20B			R7007	A D 13B
C7004	B C 13B	CN7002	A D 10A	D7032	A D 13A	<b>IC</b>			
C7005	A D 13B			D7033	A D 13A	IC7001	B C 17B	R7009	A D 14B
C7006	A D 11A			D7034	A D 12B	IC7002	A D 11B	R7010	B C 9A
C7007	A D 15A			D7035	A D 14A			R7013	A D 20B
C7008	A D 16B			D7041	A D 5B	<b>COIL</b>			
C7010	B C 9A			D7042	A D 4B	L7001	A D 19A	R7014	A D 20B
C7011	B C 10A			D7043	A D 3B			R7015	B C 14B
C7013	A D 4A			D7044	A D 1B	<b>REGISTOR</b>			
				D7045	A D 1B	R7001	A D 19B	R7016	A D 11B
				D7046	A D 7B	R7002	A D 19B	FW7001	A D 21A
						R7003	A D 19B	S7002	A D 3A
								S7003	A D 5B
								S7004	A D 8A
								S7005	A D 9B
								S7024	A D 2A
								S7025	A D 13C
								S7032	A D 13C
								S7033	A D 6A
								S7034	A D 8A
								S7035	A D 9B

■ MAIN CIRCUIT BOARD

<03> MAIN  
LPB10238-001B

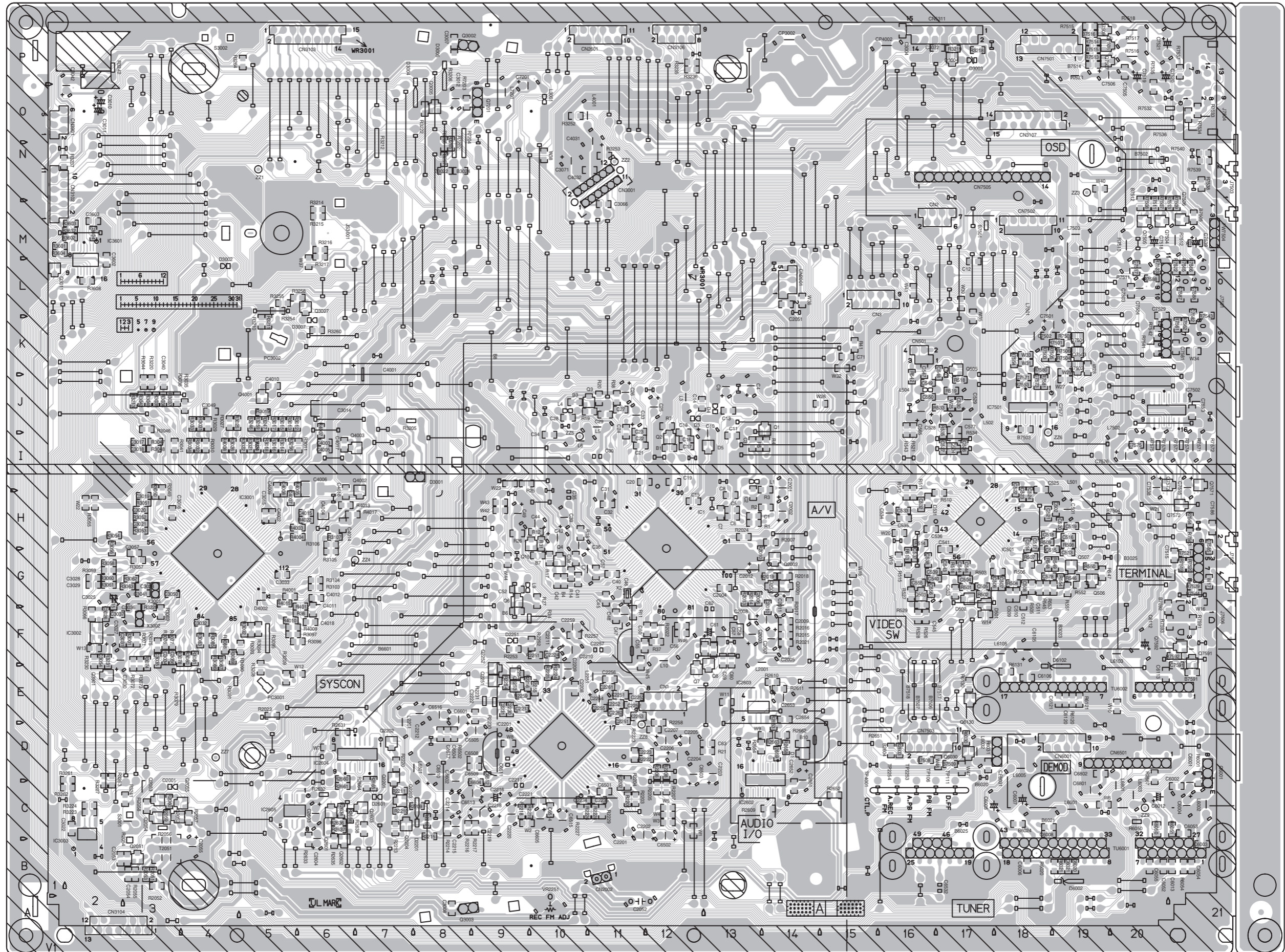



COMPONENT PARTS LOCATION GUIDE <MAIN> LPB10238-001B

Table listing component parts locations with columns for REF.NO., LOCATION, and component names like CAPACITOR, RESISTOR, COIL, TRANSISTOR, CONNECTOR, and DIODE.

FDP GRID ASSIGNMENT AND ANODE CONNECTION

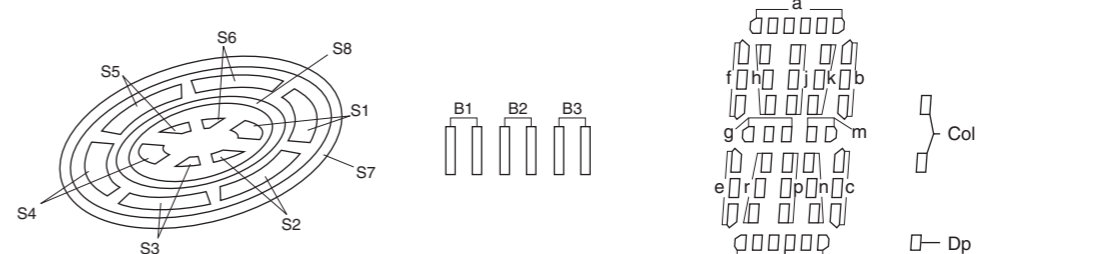
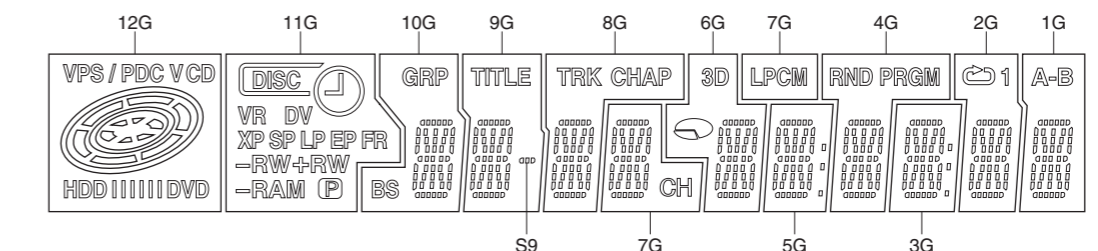
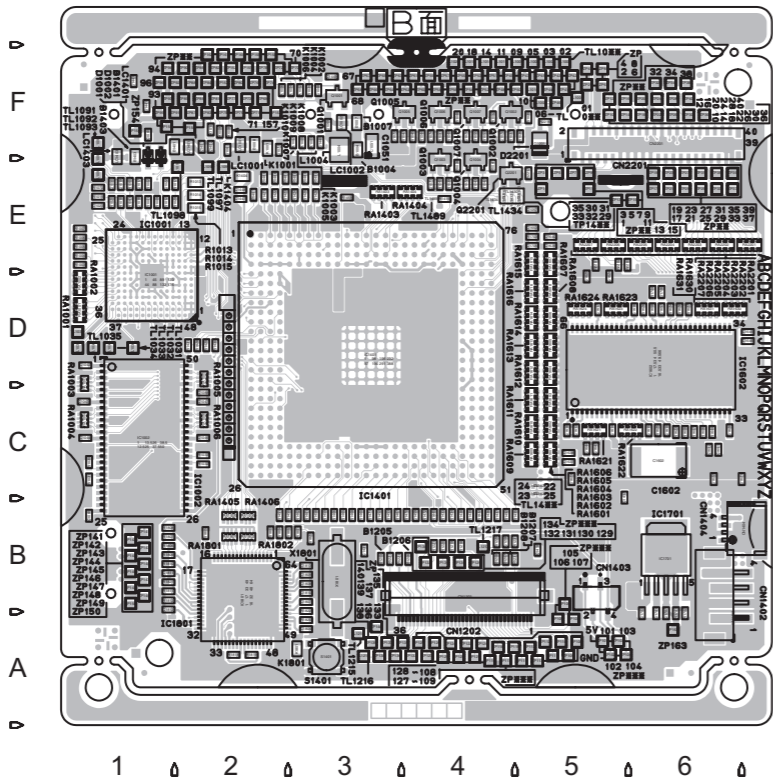

Table mapping FDP Grid assignments (P1-P16) to their corresponding components and anode connections across grids 12G to 1G.



DIGITAL CIRCUIT BOARD

<02> DIGITAL LPB10236-001D -FOIL SIDE-



<02> DIGITAL LPB10236-001D -COMPONENT SIDE-

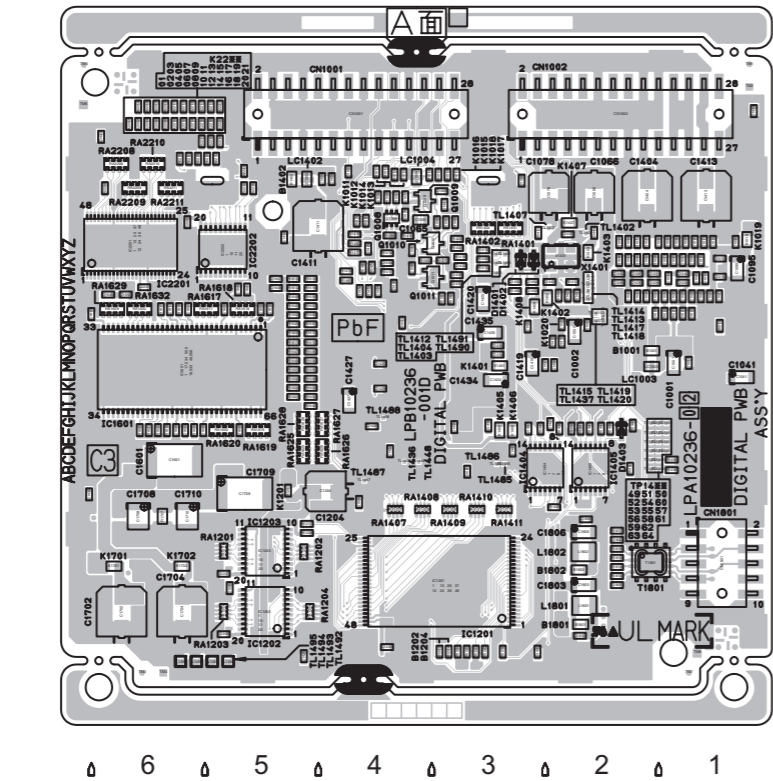

COMPONENT PARTS LOCATION GUIDE <DIGITAL> LPB10236-001D

Table listing component parts locations with columns for REF.NO. and LOCATION across various categories like CAPACITOR, DIODE, IC, COIL, TRANSISTOR, RESISTOR, and CONNECTOR.

## CPU PIN FUNCTION

<SYSCON IC3001>			
PIN NO.	LABEL	IN/OUT	FUNCTION
1	CTL[+]	IN/OUT	CTL(+) SIGNAL
2	SVss	-	GND
3	CTL[-]	IN/OUT	CTL(-) SIGNAL
4	CTLBIAS	-	CTL BIAS VOLTAGE
5	CTLFB	IN	CTL PULSE FEEDBACK
6	CTLAMPOUT	OUT	CTL PULSE OUTPUT
7	CTLSMTIN	IN	CTL PULSE OUTPUT
8	CFG	IN	CAPSTAN FG PULSE INPUT
9	SVcc	-	SYSTEM POWER
10	Avcc	-	SYSTEM POWER
11	NORM/MESEC/S_DET	IN	SQPB:H/MESECAM:M/NORMAL:L
12	WIDE_DET2/AFC2	IN	NOT USED/TUNING CHECK
13	LSA	IN	MECHANISM MODE DETECT (A)
14	START_SENSOR	IN	START SENSOR
15	END_SENSOR	IN	END SENSOR
16	LSB	IN	MECHANISM MODE DETECT (B)
17	LSC	IN	MECHANISM MODE DETECT (C)
18	LED/RF_AGC	IN	DETECT THE MTS MODE
19	WIDE_DET	IN	S1/S2 DETECT
20	BS_ANT/AFC	IN	TUNING CHECK
21	VIDEO_ENV	IN	AUTO TRACKING DTECT/INPUT THE AVERAGE OF PLAYBACK VIDEO SIGNAL
22	A.ENV/ND[L]	IN	AUDIO PB FM ENV. INPUT/NON HI-FI MODE:L
23	Avss	-	GND
24	CTL_GAIN/TEST	OUT	CONTROL AMP OUT FREQUENCY RESPONSE SWITCHIN
25	A.MUTE_VDR[H]	OUT	AUDIO MUTE CONTROL FOR VDR(MUTE:H)
26	P.MUTE_VDR[H]	OUT	PICTURE MUTE CONTROL FOR VDR(MUTE:H)
27	C.BIAS2/CONV_CTL	OUT	ADD THE DC BIAS TO COLOR OUTPUT/RF CONVERTER CONTROL
28	CAP_M_F/R	OUT	CAPSTAN MOTOR REVERSE CONTROL (FWD:L/REV:H)
29	RC_IN	IN	REMOTE CONTROL DATA INPUT
30	INPUT_SEL1	OUT	VIDEO SIGNAL INPUT SELECT
31	GR_ON[L]	-	NOT USED
32	BS_REC_LINK/COMPU_IN	-	NOT USED
33	INPUT_SEL5/COMPU_OUT	-	NOT USED
34	INPUT_SEL2	OUT	VIDEO SIGNAL INPUT SELECT
35	LM_F/R[S/LMC1]	OUT	LOADING MOTOR DRIVE
36	LSD[LMC2]	IN	MECHANISM MODE DETECT (D)
37	BS_P_CTL[H]/EDS_CS[L]	OUT	EDS CHIP SELECT
38	SB_GAIN[PWM]	OUT	VOLTAGE CONTROL SIGNAL FOR VIDEO FREQUENCY RESPONSE
39	STB	OUT	CLOCK OUTPUT PERMISSION
40	POWER_DET	IN	DETECTION SIGNAL FOR POWER DOWN OF AC POWER SUPPLY
41	REC_SAFETY	IN	REC SAFETY SWITCH DETECT (SW ON:L)
42	PROTECT	IN	DETECTION VOLTAGE FOR SW POWER SUPPLY
43	Vss	-	GND
44	C_BIAS1/RMO	OUT	ADD THE DC BIAS TO COLOR OUTPUT
45	Vcc	-	SYSTEM POWER
46	KBUS_DATA_IN	IN	SERIAL DATA TRANSFER INPUT FROM DVD CPU
47	KBUS_DATA_OUT	OUT	SERIAL DATA TRANSFER OUTPUT TO DVD CPU
48	KBUS_CLK	OUT	SERIAL DATA TRANSFERER CLOCK FOR DVD CPU
49	12C_DATA_AV	OUT	SERIAL DATA TRANSFER OUTPUT FOR AV IC
50	12C_CLK_AV	IN/OUT	SERIAL DATA TRANSFER CLOCK FOR AV IC
51	S.DATA_TO_SYS	IN	SERIAL DATA TRANSFER OUTPUT FROM THE ON-SCREEN TO THE FDP DRIVER
52	S.DATA_FR_SYS	OUT	SERIAL DATA TRANSFER OUTPUT FROM THE FDP DRIVER TO THE ON-SCREEN
53	S.CLK	OUT	SERIAL DATA TRANSFERER CLOCKFOR ONSCREEN IC
54	SP_FG	IN	DETECTION SIGNAL FOR SUPPLY REEL ROTATION/TAPE REMAIN
55	TU_FG	IN	DETECTION SIGNAL TAKE-UP REEL ROTATION/TAPE REMAIN
56	KBUS_REQ(IN)	OUT	SERIAL DATA TRANSFER REQUEST TO DVD CPU

PIN NO.	LABEL	IN/OUT	FUNCTION
57	BS_12C_CLK	-	NOT USED
58	N_REC_ST[H]	OUT	NORMAL AUDIO SOUND RECORDING START
59	JUST_CLOCK/EDS[H]	IN	VIDEO SIGNAL FIELD DETECT
60	TU_12C_DATA	OUT	DATA OUTPUT TO TUNER
61	TU_12C_CLK	OUT	CLOCK OUTPUT TO TUNER
62	FWE	-	FLASH WRITE ENABLE
63	NMI	-	NOT USED
64	X2	-	TIMER CLOCK(32kHz)
65	X1	-	TIMER CLOCK(32kHz)
66	RES	-	RESET TERMINAL(RESET ON:L)
67	OSC1[IN]	IN	MAIN SYSTEM CLOCK(10MHz)
68	Vss	-	GND
69	OSC2[OUT]	IN	MAIN SYSTEM CLOCK(10MHz)
70	Vcc	-	SYSTEM POWER
71	MODE	-	NOT USED
72	SYNC_DET[H]	IN	DETECTION OF VIDEO SYNC SIGNAL (DETECTED : H)
73	S.CASS[H]	IN	DETECTION SIGNAL FOR SVHS CASSETTE(SVHS:H)
74	A.MUTE_VHS[H]	OUT	AUDIO MUTE CONTROL FOR VHS(MUTE:H)
75	12C_CLK2	OUT	SERIAL DATA TRANSFER CLOCK FOR MEMORY IC
76	12C_DATA2	IN/OUT	SERIAL DATA TRANSFER OUTPUT FOR MEMORY IC
77	BS_12C_DATA	-	NOT USED
78	SYNC_DET_VDR[L]	IN	DETECTION OF VIDEO SYNC SIGNAL FOR VDR (DETECTED : L)
79	EXP_CLK	OUT	EXPANDER IC DATA TRANSFER CLOCK
80	I.MUTE[L]	OUT	INTERFACE VIDEO SIGNAL MUTING CONTROL OUTPUT
81	TRICK[H]	OUT	SLOW/STILL/SEARCH MODE : H
82	Vcc	-	SYSTEM POWER
83	A.MUTE[H]	OUT	AUDIO MUTE CONTROL (MUTE:H)
84	Vss	-	GND
85	SP_SHORT[H]	OUT	MODE SELECT
86	SLOW_PULSE	-	NOT USED
87	VP_CTL	-	NOT USED
88	H_REC_ST[H]	OUT	HI-FI AUDIO SOUND RECORDING START
89	LINE2INFO	-	NOT USED
90	ANT_CTL/CH_SW	OUT	NOT USED/RF CONVERTER CHANNEL SELECT
91	OSD_CS	OUT	ONSCREEN IC CHIP SELECT
92	E5_RESET	OUT	RESET OUTPUT TO IC1401
93	HI_S_FFREW	OUT	HIGH SPEED FF/REW CONTROL
94	ADC_RST[L]	OUT	STEREO A/D CONVERTER RESET PULSE
95	EXP1_DATA	OUT	SERIAL DATA TO EXPAND IC
96	P.SAVE[L]	OUT	POWER SAVE MODE:H
97	P_CTL[H]	OUT	POWER ON/OFF CONTRPL (POWER ON:H)
98	C_SYNC	IN	COMPOSITE SYNC INPUT
99	A_FF	OUT	AUDIO FF OUTPUT
100	V_FF	OUT	ROTATION DETECTION SIGNAL FOR DRUM MOTOR /TIMING CONTROL SIGNAL FOR REC
101	CAPPWM	OUT	CAPSTAN MOTOR CONTROL
102	DRUMPWM	OUT	DRUM MOTOR CONTROL
103	BIT_IN[H]	-	NOT USED
104	P.MUTE_VDR[L]	OUT	PICTURE MUTE CONTROL FOR DVD (MUTE ON:L)
105	ET_REC[H]	OUT	S-VHS ET REC MODE:H
106	P.MUTE_VHS[L]	OUT	PICTURE MUTE CONTROL FOR VHS (MUTE ON:L)
107	DFG	IN	DRUM FG PULSE INPUT
108	DFG	IN	DRUM FG PULSE INPUT
109	Vcc	-	SYSTEM POWER
110	V.PULSE	OUT	V.PULSE ADDITION TIMING CONTROL
111	Vss	-	GND
112	CTLREF	-	CTL REFERENCE VOLTAGE

## SYSTEM CONTROL BLOCK DIAGRAM

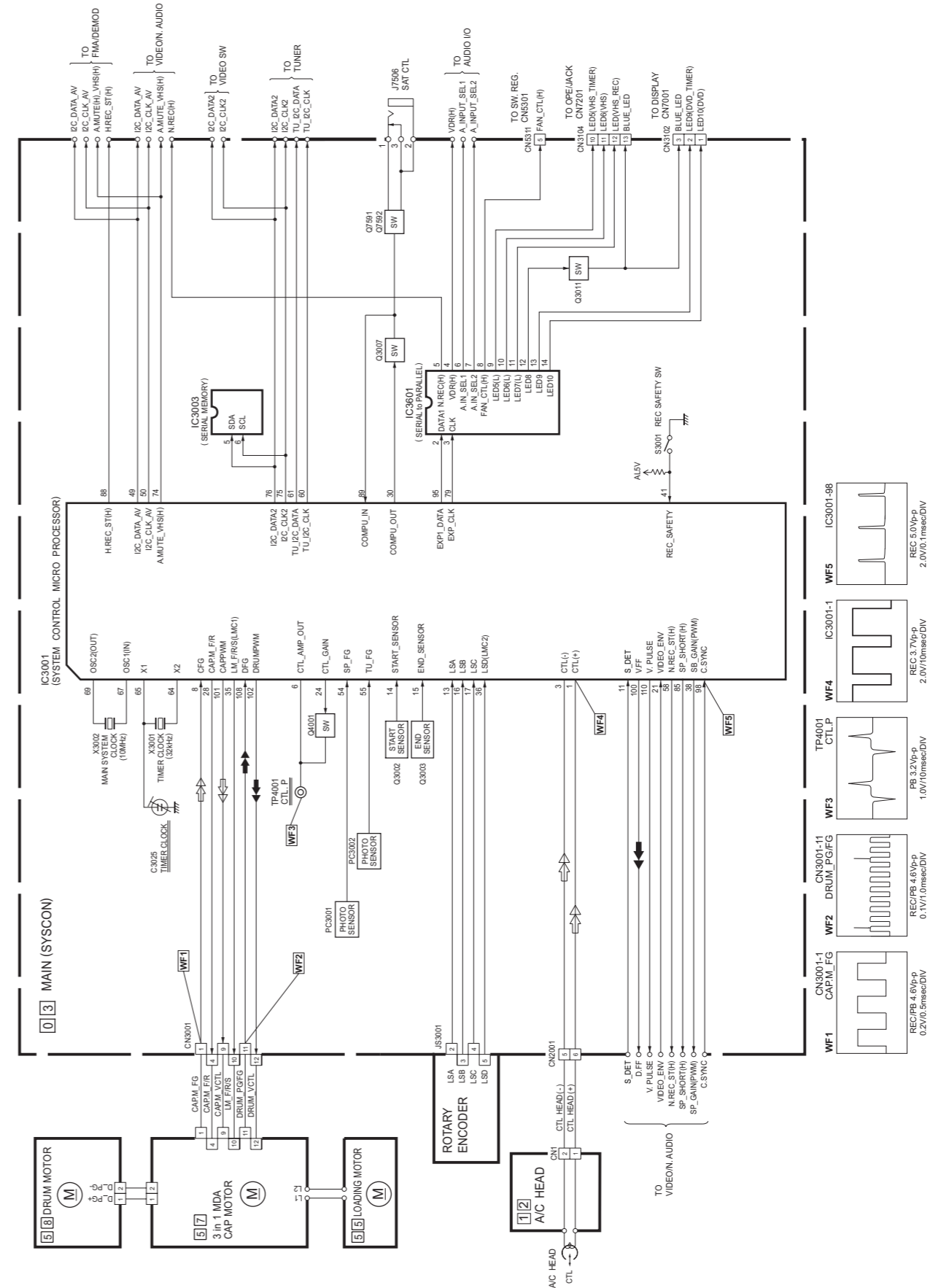

# AUDIO BLOCK DIAGRAM

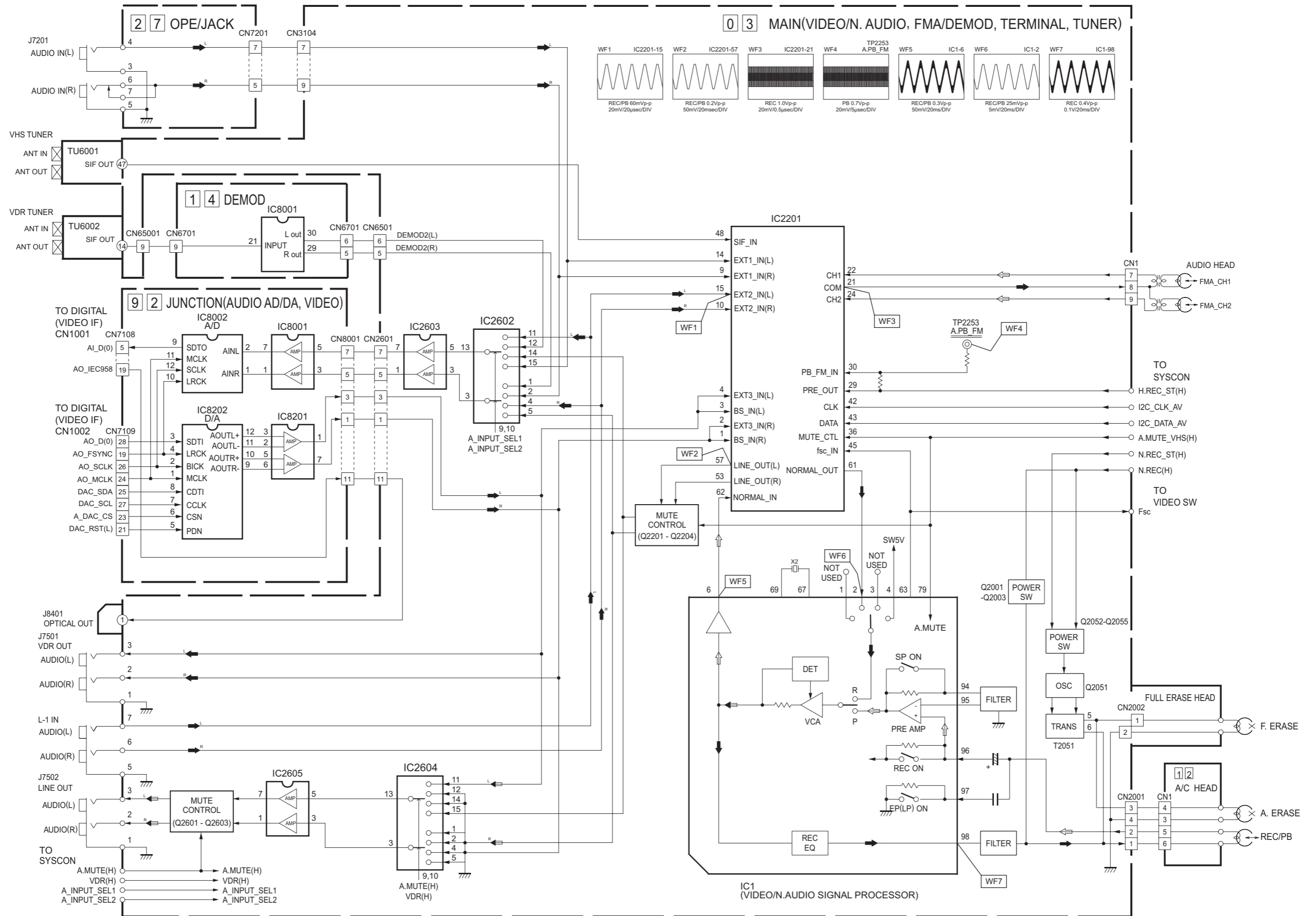

VIDEO BLOCK DIAGRAM(1)

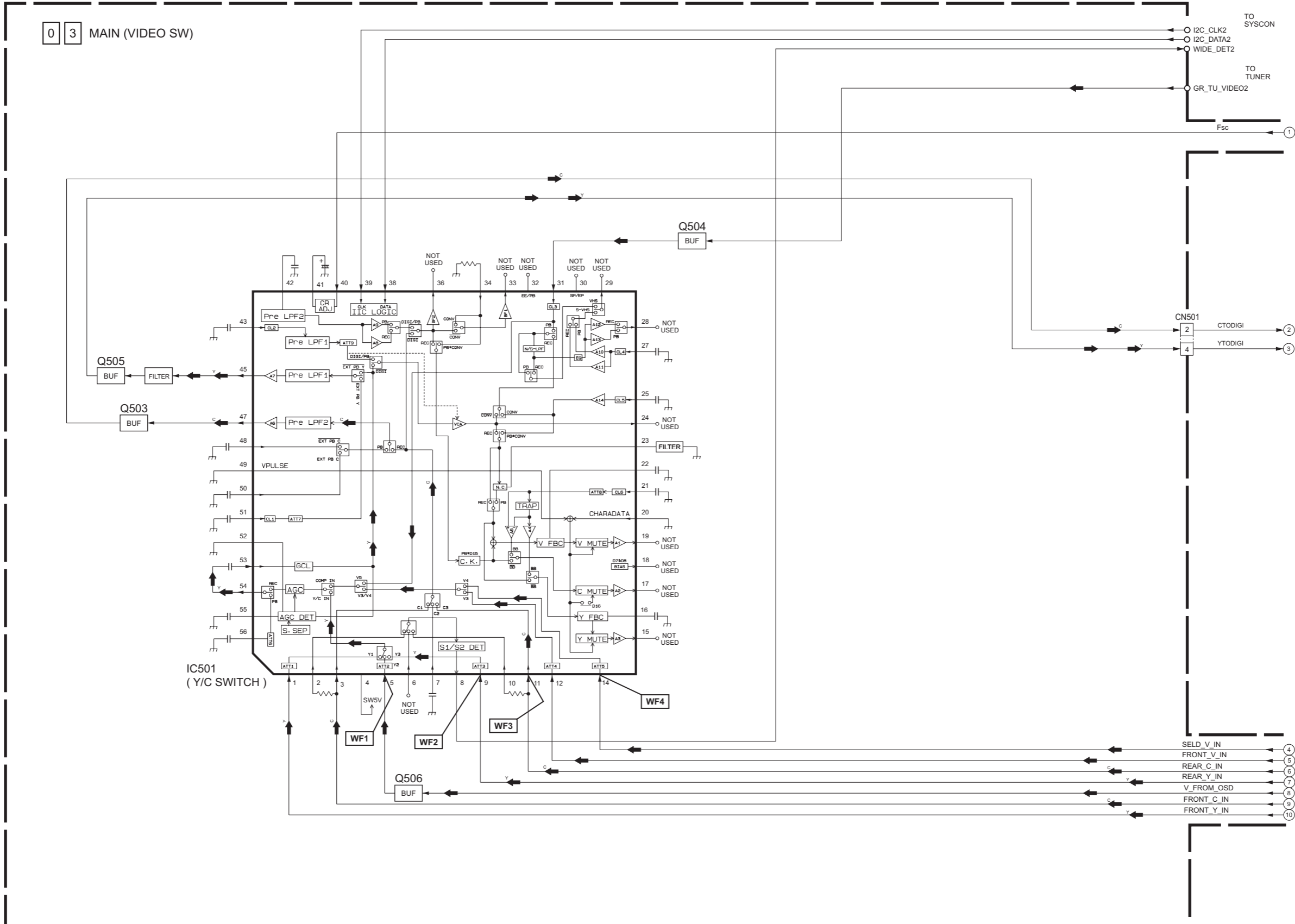
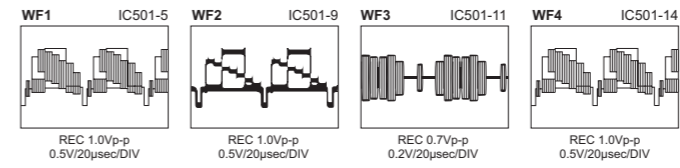

**VIDEO BLOCK DIAGRAM(2)**

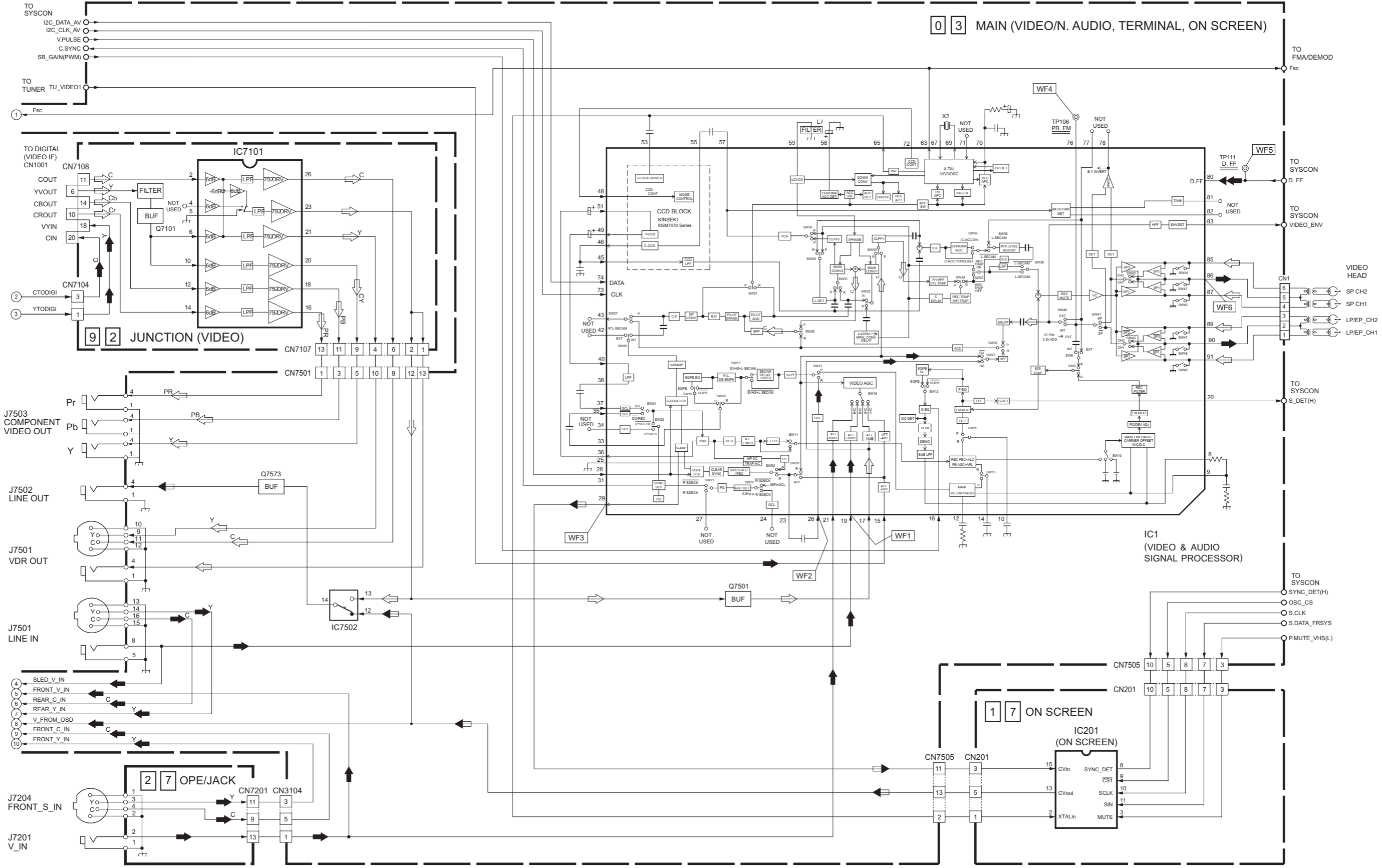
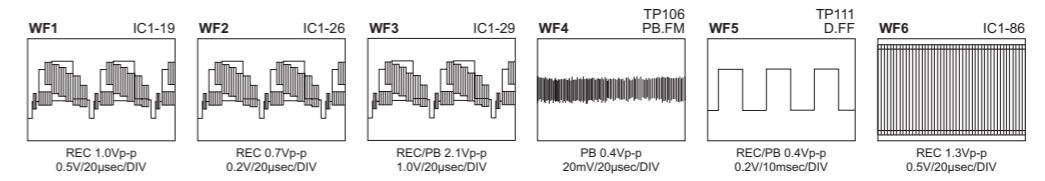

■ DIGITAL BLOCK DIAGRAM

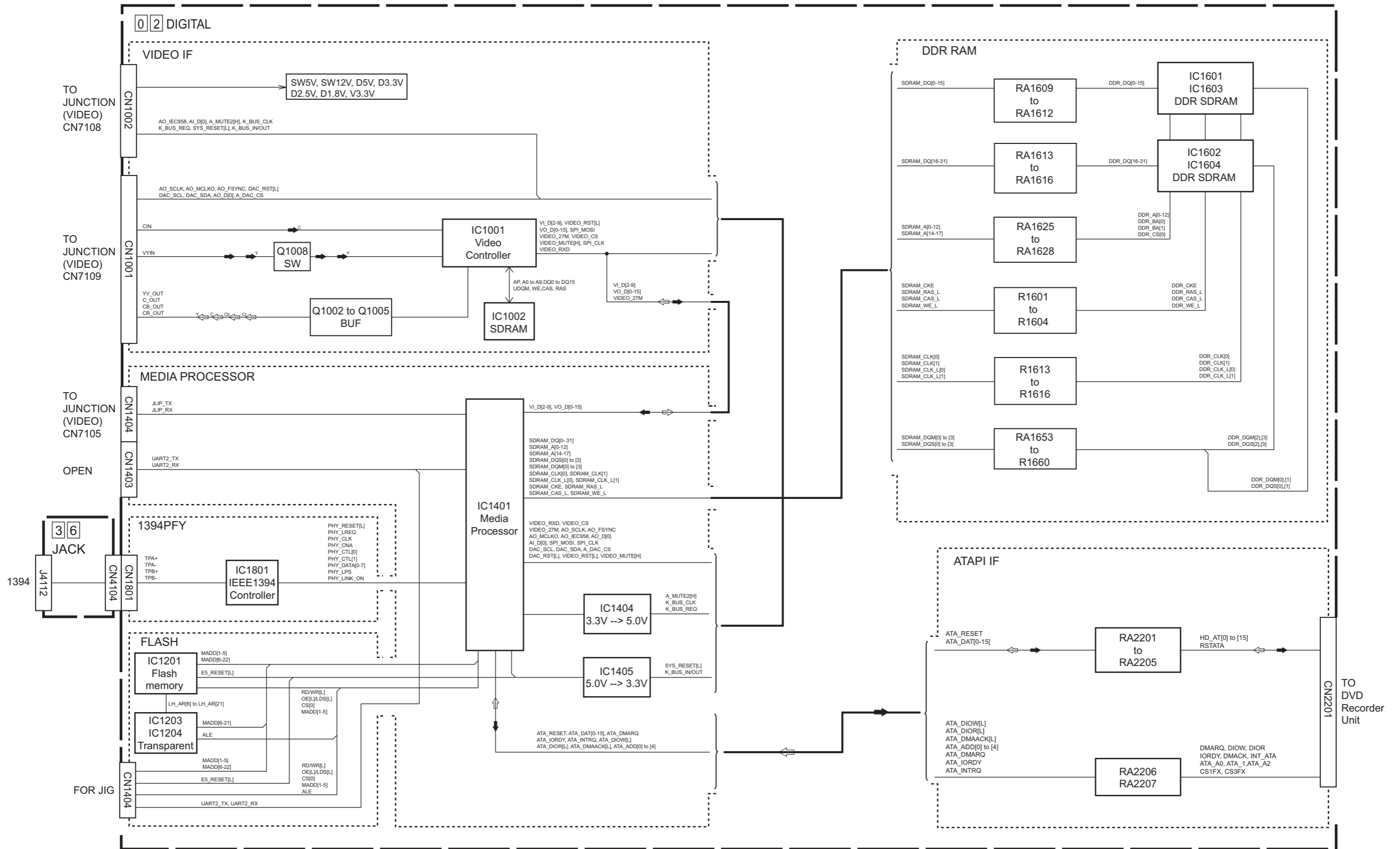



# PARTS LIST

## SAFETY PRECAUTION

Parts identified by the  $\triangle$  symbol are critical for safety. Replace only with specified part numbers.

## BEWARE OF BOGUS PARTS

Parts that do not meet specifications may cause trouble in regard to safety and performance. We recommend that genuine JVC parts be used.

### 1. EXPLODED VIEW

#### 1.1 PACKING AND ACCESSORY ASSEMBLY <M1>

The instruction manual to be provided with this product will differ according to the destination.

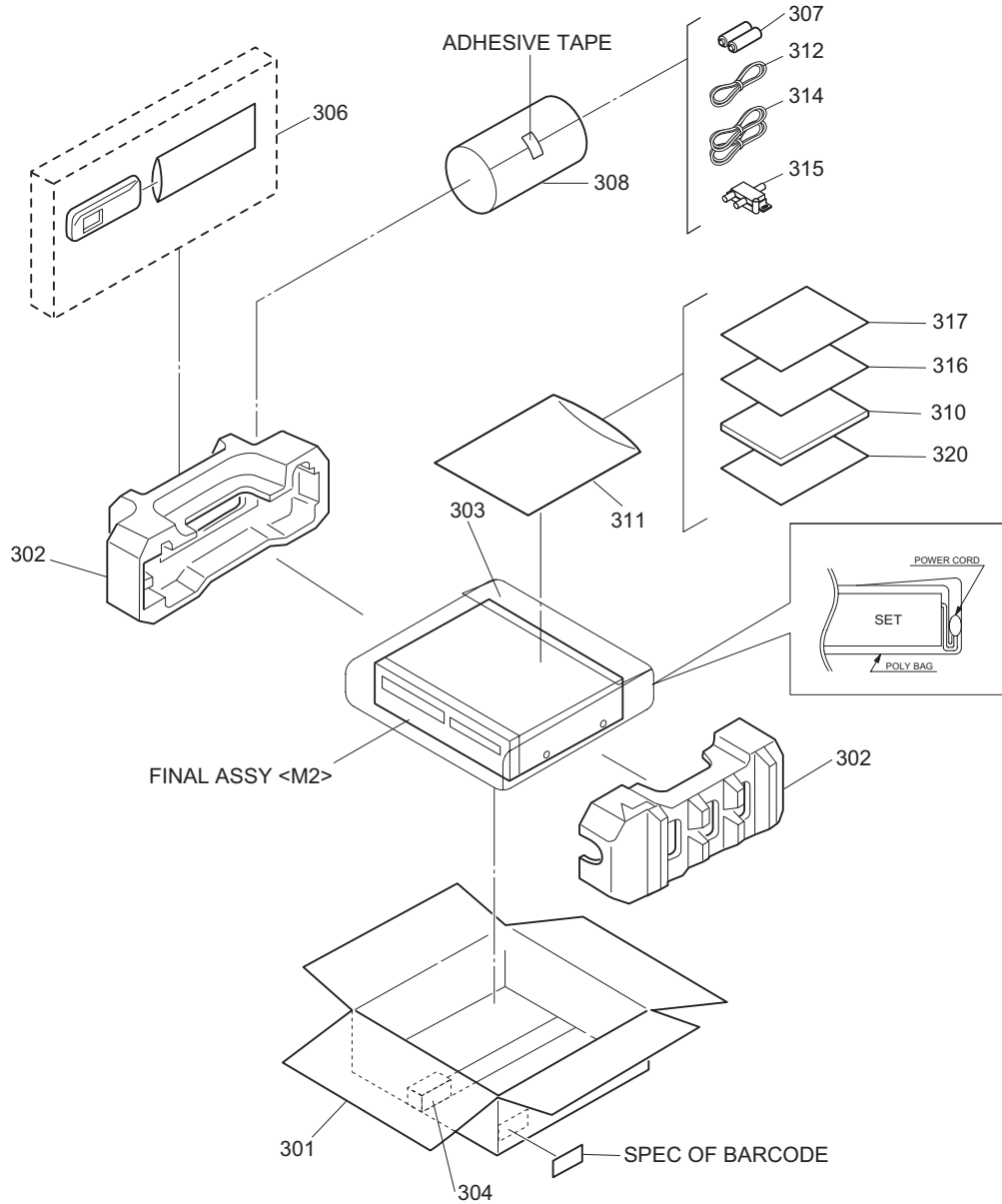

## 1.2 FINAL ASSEMBLY <M2>

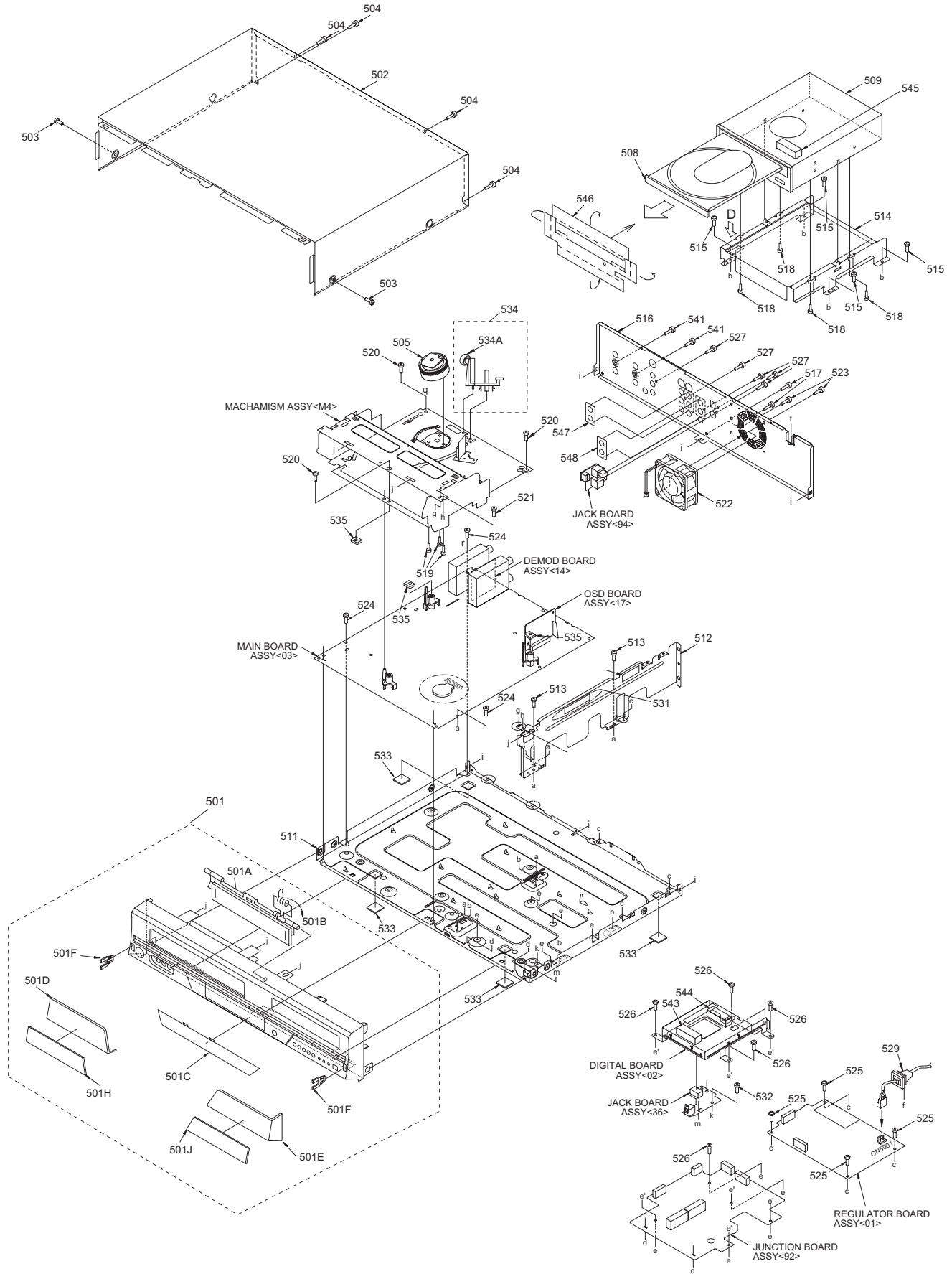

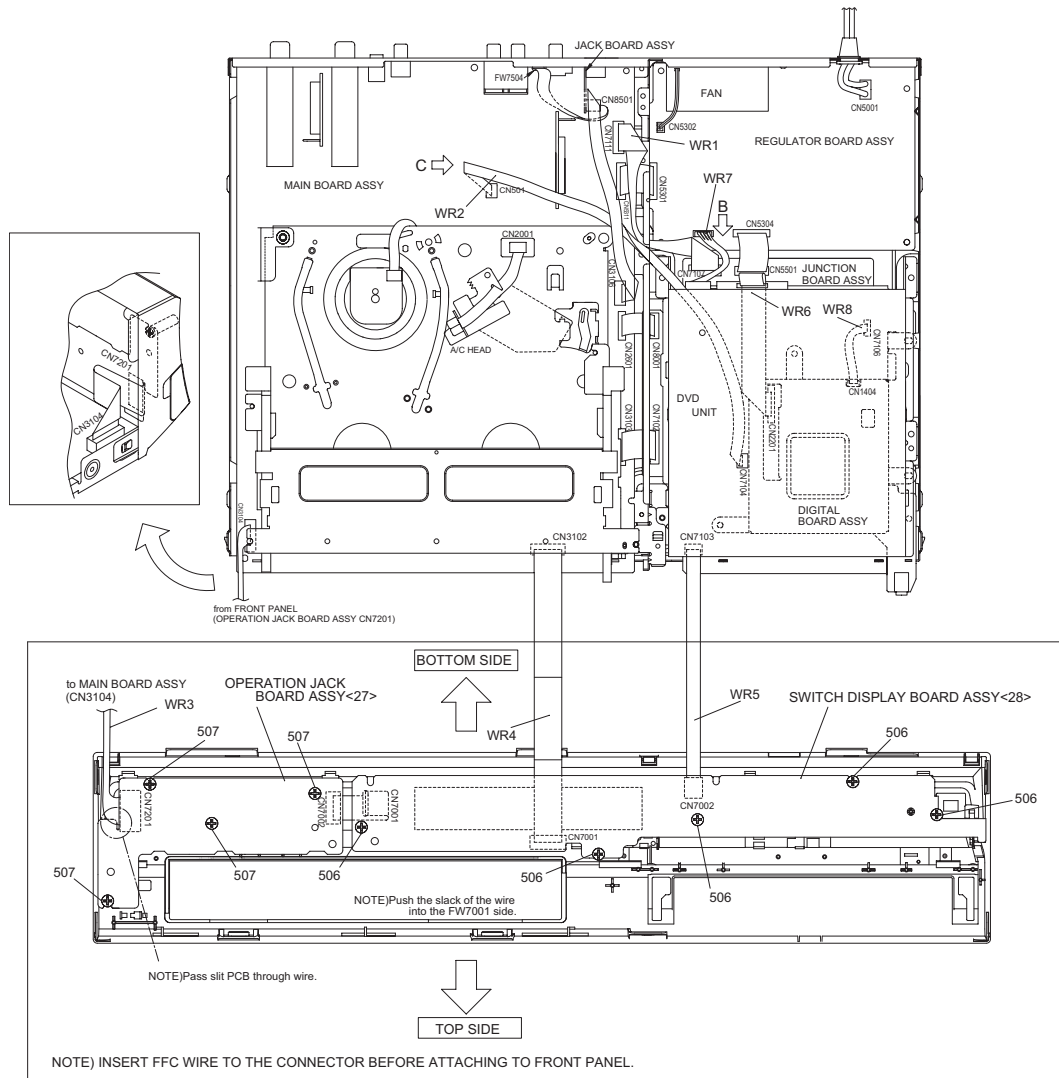

5. Insert direction of FCC WIRE as follows.



6. FFC WIRE and DRUM FPC WIRE should be inserted as follows.

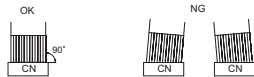

7. Insert direction of POWER CORD.

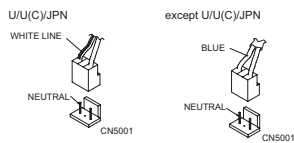

8. Insert the wire to even the root of connector completely at the same time as inserting each wire.

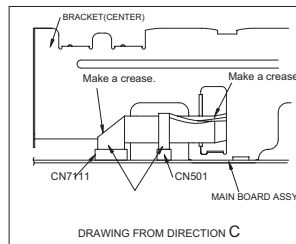

NOTE) FJ CONN should be insert as follows.

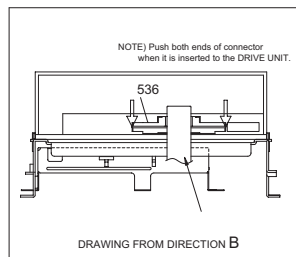
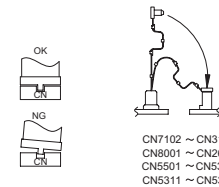

NOTE) Replace the attached FITTING.

<HOW TO REMOVE>

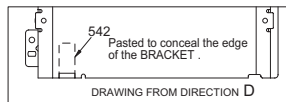
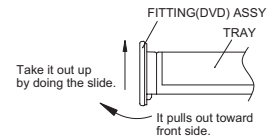

### 1.3 MECHANISM ASSEMBLY <M4>

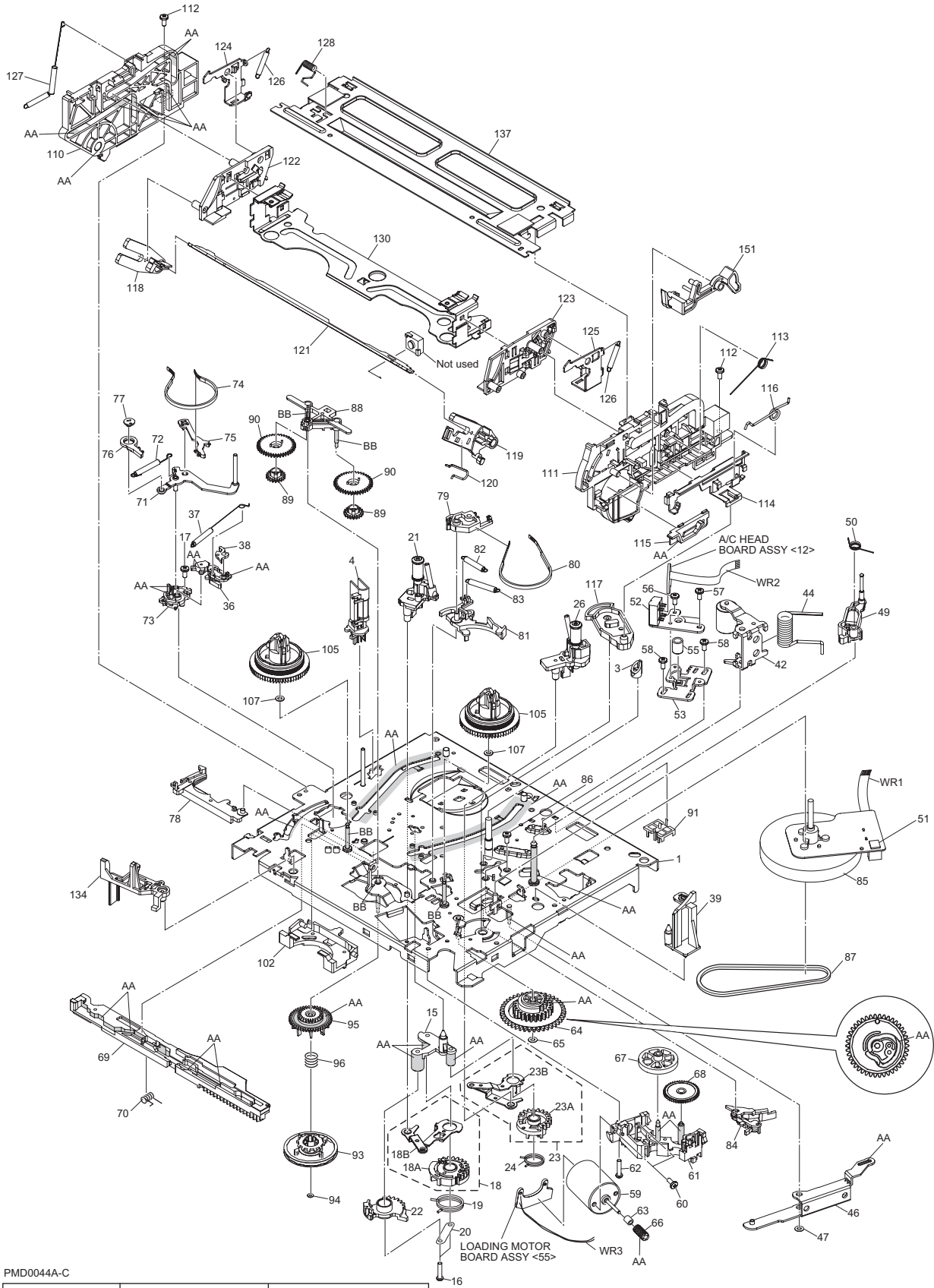

PMD0044A-C

Classification	Part No.	Symbol in drawing
Grease	KYODO-SH-JB	AA
Oil	COSMO-HV56	BB

**NOTE:** The section marked in **AA** and **BB** indicate lubrication and greasing areas.

MODEL	MARK
DR-MV1SUC	A
DR-MV1SUS	B

## 2. PARTS LIST

### PACKING AND ACCESSORY ASSEMBLY <M1>

△ Symbol No.	Part No.	Part Name	Description	Local
	301	LP31338-010A	PACKING CASE	
	302	LP31340-001A	CUSHION ASSY	
	303	PQM30021-105	POLY BAG	
	304	LP31258-001A	MINI CUSHION	
	306	RM-SDR013J	REMOCON	
	307	-----	BATTERY	R6 TYPE(x2)
	308	QPC02202230P	POLY BAG	22cm x 22cm
△	310	LPT0952-001A	INST.BOOK	(ENGLISH) A
△	310	LPT0952-002A	INST.BOOK	(FRENCH) A
△	310	LPT0918-001A	INST.BOOK	(ENGLISH) B
	311	QPC02503530P	POLY BAG	25cm x 35cm
	312	QAM0501-003	RF CABLE	
	314	QAM0523-003	RF CABLE	ANT. SPLITTER(x2) B
	315	QAU0361-001	ANT. SPLITTER	B
	316	BT-52006-2	WARRANTY CARD	A
	317	BT-51034-2	REGIST CARD	B
	320	LP30666-005C	SHEET(COUPON)	

### FINAL ASSEMBLY <M2>

△ Symbol No.	Part No.	Part Name	Description	Local
△	501	LP10526-005A	FRONT PANEL ASSY	
	501A	LP21232-002A	CASSETTE DOOR	
	501B	PQ46448	TORSION SPRING	
	501C	LP31358-003A	DISPLAY WINDOW	
	501D	LP31353-001A	DOOR(L)	
	501E	LP31354-001A	DOOR(R)	
	501F	PU60109	CATCHER	(x2)
	501H	LP31356-005A	WINDOW(L)	
	501J	LP31357-004A	WINDOW(R)	
△	502	LP10460-004B	TOP COVER	
	503	QYSBSG3006NA	TAP SCREW	M3 x 6mm TOP SIDE(x2)
	504	QYSBSG3006NA	TAP SCREW	M3 x 6mm TOP REAR(x4)
	505	PDV2531C	DRUM FINAL ASSY	
	506	QYTDSF2608ZA	TAP SCREW	M2.6 x 8mm SWITCH DISPLAY(x5)
	507	QYTDSF2608ZA	TAP SCREW	M2.6 x 8mm OPERATION JACK(x4)
	508	LP31372-002A	FITTING(DVD) ASSY	
△	509	QAL0551-001	DRIVE UNIT	
△	511	LP10525-001D	BOTTOM CHASSIS	
	512	LP21222-001B	BRACKET(CENTER)	
	513	LP31391-001A	SPECIAL SCREW	BRACKET(CENTER)(x2)
	514	LP21223-001A	BRACKET(DVD UNIT)	
	515	LP31391-001A	SPECIAL SCREW	BRACKET(DVD)(x4)
△	516	LP21134-012A	REAR COVER	
	517	QYSBSG3006NA	TAP SCREW	M3 x 6mm REAR COVER(x2)
	518	QYTDST3006ZA	TAP SCREW	M3 x 8mm DVD UNIT(x4)
	519	QYSPSPD3008ZA	SCREW	M3 x 8mm DRUM(x3)
	520	LP31391-002A	SPECIAL SCREW	MECHANISM(x3)
	521	LP31391-001A	SPECIAL SCREW	HOUSING
	522	QAR0310-001	FAN MOTOR	
	523	QYTDSF3008MA	TAP SCREW	M3 x 8mm FAN(x2)
	524	LP31391-001A	SPECIAL SCREW	MAIN(x3)
	525	LP31391-001A	SPECIAL SCREW	REGULATOR(x4)
	526	LP31391-001A	SPECIAL SCREW	JUNCTION(x5)
	527	QYTDSF3008MA	TAP SCREW	M3 x 8mm JACK(x5)
△	529	QMPD190-170-K	POWER CORD(JP)	1.7m BLACK
	531	LP31390-001A	BARCODE LABEL	
	532	LP31391-001A	SPECIAL SCREW	JACK
	533	LP31348-001A	FOOT	(x4)
	534	LP40910-002G	HEAD CLEANER ASSY	
	534A	PQ46419-2	CLEANER	
	535	LP41140-001A	INSULATOR	(x3)
	536	QGZ0018A1-40	CONNECTOR	(1-40)
	541	QYTDST3005MA	TAP SCREW	M3 x 5mm TUNER(x2)
	542	LP30002-0F6A	SPACER	
	543	LP41171-001A	SHIELD TIGHT	
	544	LP41171-001A	SHIELD TIGHT	
	545	LP41171-001A	SHIELD TIGHT	
	546	LP31417-001A	SHIELD PLATE	

△ Symbol No.	Part No.	Part Name	Description	Local
	547	LP31345-001A	EARTH PLATE	
	548	LP31345-001A	EARTH PLATE	
	WR1	QUQ112-1318CG	FFC WIRE	JUNCTION CN7107A/MAIN CN7501
	WR2	QUQ212-0430CG	FFC WIRE	JUNCTION CN7104/MAIN CN501
	WR3	QUQ112-1308CG	FFC WIRE	OPERATION JACK CN7201/MAIN CN3104
	WR4	WJT0151-001A	E-CARD WIRE	SWITCH DISPLAY CN7001/MAIN CN3102
	WR5	QUQ212-0410CG	FFC WIRE	JUNCTION CN7103/SWITCH DISPLAY CN7002
	WR6	QUQ105-4020AF	FFC WIRE	DVD UNIT/DIGITAL CN2201
	WR7	QJJ032-040804	SIN CR C-C WIRE	REGULATOR CN6303/DVD UNIT
	WR8	QUQ210-0406CC	FFC WIRE	DIGITAL CN404/JUNCTION CN7105

### MECHANISM ASSEMBLY <M4>

△ Symbol No.	Part No.	Part Name	Description	Local
	1	LP21039-003A	MAIN DECK ASSY	
	3	LP40097-002E	GUIDE POLE CAP	
	4	NAH0004-001	FULL ERASE HEAD	
	15	LP30958-001B	LOADING GEAR BASE	
	16	QYTPST2620ZA	TAP SCREW	M2.6 x 20mm(x2)
	17	QYTDST2606ZA	TAP SCREW	M2.6 x 6mm
	18	LP40798-002A	LOADING GEAR(SUPPLY) ASSY	
	18A	LP21040-001A	LOADING GEAR(SUPPLY)	
	18B	LP40799-002A	LOADING ARM(SUPPLY) ASSY	
	19	LP40837-001A	TORSION SPRING(SUPPLY)	
	20	LP40903-004A	FIXING PLATE	
	21	LP40806-001D	POLE BASE ASSY(SUPPLY)	
	22	LP30959-001B	LOADING GEAR	
	23	LP40802-002A	LOADING GEAR(TAKE UP) ASSY	
	23A	LP21041-001D	LOADING GEAR(TAKE UP)	
	23B	LP40803-002A	LOADING ARM(TAKE UP) ASSY	
	24	LP40838-001A	TORSION SPRING(TAKE UP)	
	26	LP40808-001E	POLE BASE ASSY(TAKE UP)	
	36	LP21055-001G	TAKE UP LEVER	
	37	LP40943-001A	TENSION SPRING	
	38	LP40859-001D	T-UP HEAD	
	39	LP30961-001C	LID GUIDE	
	42	LP40810-003A	PINCH ROLLER ARM ASSY	
	44	LP40840-001D	TORSION SPRING	
	46	LP30963-002A	PRESS LEVER	
	47	PQM30017-24	SLIT WASHER	
	49	LP40813-001D	GUIDE ARM ASSY	
	50	LP40841-001A	TORSION SPRING	
	51	LP30002-090A	SPACER	
	52	NAH0003-001	AC HEAD	
	53	LP30965-003A	HEAD BASE	
	55	LP40842-001D	COMPRESSION SPRING	
	56	QYTDST2006MA	TAP SCREW	M2 x 6mm
	57	LP41036-002A	A/C ADJ. SCREW	(x2)
	58	QYTDST2606ZA	TAP SCREW	M2.6 x 6mm(x2)
	59	QAR0289-001	LOADING MOTOR	
	60	QYTPSP3003ZA	SCREW	M3 x 3mm(x2)
	61	LP21056-002J	MOTOR BRACKET	
	62	QYTPST2620ZA	TAP SCREW	M2.6 x 20mm
	63	LP40814-001B	WORM BEARING	
	64	LP21044-001E	CONTROL CAM	
	65	PQM30017-24	SLIT WASHER	
	66	LP40815-001A	WORM GEAR	
	67	LP40816-001B	HELICAL GEAR	
	68	LP40817-001A	CONNECT GEAR	
	69	LP10400-001N	CONTROL PLATE	
	70	LP40843-001A	TORSION SPRING	
	71	LP40818-002A	TENSION ARM ASSY	
	72	LP40844-001F	TENSION SPRING	
	73	LP21045-001E	TENSION ARM BASE	
	74	LP40821-001A	TENSION BAND ASSY	
	75	LP30967-001B	BAND HOLDER-1	
	76	LP30968-001C	BAND HOLDER-2	
	77	LP40822-002B	ADJUST PIN	
	78	LP31000-005E	TENSION ARM LEVER	
	79	LP21046-001C	MAIN BRAKE(TAKE UP)	
	80	LP40824-001A	BAND BRAKE ASSY	
	81	LP30969-002B	BRAKE LEVER	
	82	LP30003-033B	TENSION SPRING	

MODEL	MARK
DR-MV1SUC	A
DR-MV1SUS	B

△ Symbol No.	Part No.	Part Name	Description	Local	△ Symbol No.	Part No.	Part Name	Description	Local
83	LP30003-035B	TENSION SPRING			D5001	or D3SBA60	DIODE		
84	LP40825-001B	CAPSTAN BRAKE ASSY			D5101	SARS01-T2	SI DIODE		
△ 85	QAR0267-002	CAPSTAN MOTOR			D5103	1F4G-T2	FR DIODE		
86	QYTPSG2606ZA	TAP SCREW	M2.6 x 6mm(x3)		D5103	or 10ERB20-T2	FR DIODE		
87	LP30005-010A	BELT	CAPSTAN MOTOR		D5103	or ERA18-02-T2	FR DIODE		
88	LP30970-001A	IDLER ARM			D5103	or AU01Z-T2	FR DIODE		
89	LP40828-004A	IDLER GEAR 1	(x2)		D5103	or 1SR153-400-T2	FR DIODE		
90	LP40829-002A	IDLER GEAR 2	(x2)		D5104	1SS133-T2	DIODE		
91	LP31014-002A	WIRE HOLDER			D5104	or 1SS270A-T2	SI DIODE		
93	LP40934-001B	CLUTCH UNIT			D5105	10ERB20-T2	FR DIODE		
94	PQM30017-47	SLIT WASHER			D5105	or ERA18-02-T2	FR DIODE		
95	LP30973-001A	DIRECT GEAR			D5105	or AU01Z-T2	FR DIODE		
96	LP40939-001A	COMPRESSION SPRING			D5105	or 1SR153-400-T2	FR DIODE		
102	LP30974-001C	CHANGE LEVER			D5105	or 1F4G-T2	FR DIODE		
105	LP21049-001A	REEL DISK	(x2)		D5106	10ERB20-T2	FR DIODE		
107	LP30017-004A	SPACER	REEL DISK(x2)		D5106	or ERA18-02-T2	FR DIODE		
110	LP10401-001L	SIDE FRAME(L)			D5106	or AU01Z-T2	FR DIODE		
111	LP10402-001M	SIDE FRAME(R)			D5106	or 1SR153-400-T2	FR DIODE		
112	QYTDST2606ZA	TAP SCREW	M2.6 x 6mm(x2)		D5106	or 1F4G-T2	FR DIODE		
113	LP40917-001D	TORSION SPRING			D5202	1SR156-400-X	SI DIODE		
114	LP30976-002A	SIDE PLATE			D5203	RL2Z-LFB2	FRD		
115	LP30977-002D	LIMIT PLATE			D5204	D1FS4A-X	SB DIODE		
116	LP40846-001C	LIMIT SPRING			D5205	RK34-LFB2	SB DIODE		
117	LP31100-002A	DRIVE LEVER			D5207	D1FS4A-X	SB DIODE		
118	LP30978-001B	DRIVE ARM(L)			D5208	RK34-LFB2	SB DIODE		
119	LP30979-001S	DRIVE ARM(R)			D5209	RK34-LFB2	SB DIODE		
120	LP40847-001B	TORSION SPRING			D5210	1F4G-T2	FR DIODE		
121	LP30980-002A	CONNECT PLATE			D5210	or PG104RS-T2	FR DIODE		
122	LP10403-001C	SIDE HOLDER(L)			D5210	or 10ERB20-T2	FR DIODE		
123	LP10404-001E	SIDE HOLDER(R)			D5210	or 1SR153-400-T2	FR DIODE		
124	LP30983-002A	LOCK LEVER(L)			D5210	or ERA18-02-T2	FR DIODE		
125	LP30984-002A	LOCK LEVER(R)			D5211	ERA18-02-T2	FR DIODE		
126	LP40924-001D	TENSION SPRING	(x2)		D5211	or 1SR153-400-T2	FR DIODE		
127	LP40972-001A	EARTH SPRING(1)			D5211	or 10ERB20-T2	FR DIODE		
128	LP40857-001B	EARTH SPRING(2)			D5211	or 1F4G-T2	FR DIODE		
130	LP30981-003A	CASSETTE HOLDER ASSY			D5212	D1FS4A-X	SB DIODE		
134	LP21051-002C	REC SAFETY LEVER			D5213	1F4G-T2	FR DIODE		
137	LP21052-002A	TOP FRAME			D5213	or 10ERB20-T2	FR DIODE		
151	LP30985-002M	DOOR OPENER			D5213	or ERA18-02-T2	FR DIODE		
WR1	WJT0117-001A	E-CARD WIRE	DRUM		D5213	or AU01Z-T2	FR DIODE		
WR2	WJT0067-001B	E-CARD WIRE	A/C HEAD CN2001		D5213	or 1SR153-400-T2	FR DIODE		
WR3	WJS0022-001A	E-FL/RB WIRE	LOADING MOTOR		D5301	MTZJ15A-T2	Z DIODE		

### REGULATOR BOARD ASSEMBLY <01>

△ Symbol No.	Part No.	Part Name	Description	Local	△ Symbol No.	Part No.	Part Name	Description	Local
PW1	LPA10248-02C1	REGULATOR BOARD ASSY			D5301	or RD15ES/B1/-T2	Z DIODE		
IC5101	STR-G6653-F9	IC			D5303	MTZJ11C-T2	Z DIODE		
IC5301	UTCTL431-T	IC			D5303	or RD11ES/B3/-T2	Z DIODE		
IC5301	or MM1431AT-T	IC			D5304	MTZJ5.6C-T2	Z DIODE		
IC5301	or L5431-T	IC			D5304	or RD5.6ES/B3/-T2	Z DIODE		
IC5301	or TL431/A/-T	IC			D5306	RK34-LFB2	SB DIODE		
IC5302	PQ5EV3	IC			D5307	RK34-LFB2	SB DIODE		
Q5304	UMD12N-W	DIGI TRANSISTOR			D5308	RK34-LFB2	SB DIODE		
Q5304	or XP4313-W	DIGI TRANSISTOR			D5309	1S4-T2	SB DIODE		
Q5305	2SD2144S/UV/-T	TRANSISTOR			D5309	or SBO40-T2	SB DIODE		
Q5305	or 2SC3576-JVC-T	TRANSISTOR			D5309	or AW04-T2	SB DIODE		
Q5306	2SC5739/QP/-	TRANSISTOR			D5312	1SS133-T2	DIODE		
Q5307	2SA1585S/QR/-T	TRANSISTOR			D5312	or 1SS270A-T2	SI DIODE		
Q5308	PDTC114EU-X	DIGI TRANSISTOR			D5313	1A3G-T2	SI DIODE		
Q5308	or DTC114EUA-X	DIGI TRANSISTOR			D5313	or ERA15-02-T2	SI DIODE		
Q5308	or UN5211-X	DIGI TRANSISTOR			D5313	or 10EDB20-T2	SI DIODE		
Q5308	or RN1302-X	DIGI TRANSISTOR			△ PC5101	PC123Y22FZ	PHOTO COUPLER		
Q5313	2SA1585S/QR/-T	TRANSISTOR			△ C5001	QFZ9073-683	MM CAPACITOR	0.068uF AC250V M	
Q5314	2SA1585S/QR/-T	TRANSISTOR			△ C5002	QFZ9051-223	MM CAPACITOR	0.022uF 250V M	
Q5315	PDTC114EU-X	DIGI TRANSISTOR			C5003	QE20639-337	E CAPACITOR	330uF 200V M	
Q5315	or DTC114EUA-X	DIGI TRANSISTOR			△ C5004	QCZ9079-472	C CAPACITOR	4700pF AC250V M	
Q5315	or UN5211-X	DIGI TRANSISTOR			△ C5005	QCZ9071-101	C CAPACITOR	100pF AC400V K	
Q5315	or RN1302-X	DIGI TRANSISTOR			C5101	QCZ0339-101Z	C CAPACITOR	100pF 1kV K	
D5001	GBJ4J	BRIDGE DIODE			C5102	QCZ0349-472Z	C CAPACITOR	4700pF 1kV K	
					C5103	QEMU1VM-276Z	E CAPACITOR	27uF 35V M	
					C5104	QCZ0136-471Z	C CAPACITOR	470pF 1kV K	
					C5105	QFLC1HJ-471Z	M CAPACITOR	470pF 50V J	
					C5106	NCB21HK-103X	C CAPACITOR	0.01uF 50V K	
					C5107	NCB21HK-221X	C CAPACITOR	220pF 50V K	
					C5202	QETN2AM-475Z	E CAPACITOR	4.7uF 100V M	
					C5203	QEMT1CM-687	E CAPACITOR	680uF 16V M	
					C5204	QEMT1CM-687	E CAPACITOR	680uF 16V M	
					C5205	QEMT1AM-128	E CAPACITOR	1200uF 10V M	
					C5206	QEC51AM-128	E CAPACITOR	1200uF 10V M	

MODEL	MARK
DR-MV1SUC	A
DR-MV1SUS	B

Symbol No.	Part No.	Part Name	Description	Local
C5207	QECS0JM-158	E CAPACITOR	1500uF 6.3V M	
C5208	QEMT1AM-108	E CAPACITOR	1000uF 10V M	
C5209	QEMU1HM-186Z	E CAPACITOR	18uF 50V M	
C5210	QEMX0JM-227Z	E CAPACITOR	220uF 6.3V M	
C5301	QFVF1HJ-154Z	MF CAPACITOR	0.15uF 50V J	
C5302	QFLC1HJ-333Z	M CAPACITOR	0.033uF 50V J	
C5303	QETN1CM-107Z	E CAPACITOR	100uF 16V M	
C5304	QETN1CM-107Z	E CAPACITOR	100uF 16V M	
C5305	QETN1AM-107Z	E CAPACITOR	100uF 10V M	
C5306	QETN1AM-107Z	E CAPACITOR	100uF 10V M	
C5307	QETN1CM-107Z	E CAPACITOR	100uF 16V M	
C5308	QETN1CM-107Z	E CAPACITOR	100uF 16V M	
C5310	QETN1HM-225Z	E CAPACITOR	2.2uF 50V M	
C5311	QETN1AM-107Z	E CAPACITOR	100uF 10V M	
C5312	QETN1AM-107Z	E CAPACITOR	100uF 10V M	
C5313	NCB21HK-471X	C CAPACITOR	470pF 50V K	
C5314	QETN1AM-107Z	E CAPACITOR	100uF 10V M	
C5315	NCB21HK-103X	C CAPACITOR	0.01uF 50V K	
△ R5001	QRZ9046-475Z	C RESISTOR	4.7MΩ 1/2W K	
R5101	QRG02GJ-683	OMF RESISTOR	68kΩ 2W J	
R5102	NRSA02J-122X	MG RESISTOR	1.2kΩ 1/10W J	
R5103	QRE141J-684Y	C RESISTOR	680kΩ 1/4W J	
R5104	NRSA02J-102X	MG RESISTOR	1kΩ 1/10W J	
R5105	QRE141J-680Y	C RESISTOR	68Ω 1/4W J	
R5106	QRE141J-392Y	C RESISTOR	3.9kΩ 1/4W J	
R5107	NRSA02J-681X	MG RESISTOR	680Ω 1/10W J	
R5108	QRT01DJ-R33X	MF RESISTOR	0.33Ω 1W J	
△ R5109	QRZ9005-470X	FUSI RESISTOR	47Ω 1/4W G	
R5301	NRSA02J-221X	MG RESISTOR	220Ω 1/10W J	
R5302	NRSA02J-472X	MG RESISTOR	4.7kΩ 1/10W J	
R5303	NRVA02D-152X	CMF RESISTOR	1.5kΩ 1/10W D	
R5304	NRVA02D-682X	CMF RESISTOR	6.8kΩ 1/10W D	
R5305	NRVA02D-243X	CMF RESISTOR	24kΩ 1/10W D	
R5306	NRVA02D-392X	CMF RESISTOR	3.9kΩ 1/10W D	
R5308	NRSA02J-122X	MG RESISTOR	1.2kΩ 1/10W J	
R5309	NRSA02J-102X	MG RESISTOR	1kΩ 1/10W J	
R5312	NRSA02J-103X	MG RESISTOR	10kΩ 1/10W J	
R5313	NRSA02J-103X	MG RESISTOR	10kΩ 1/10W J	
R5314	NRSA02J-471X	MG RESISTOR	470Ω 1/10W J	
R5315	QRE121J-820Y	C RESISTOR	82Ω 1/2W J	
R5316	NRSA02J-103X	MG RESISTOR	10kΩ 1/10W J	
R5317	NRSA02J-102X	MG RESISTOR	1kΩ 1/10W J	
R5318	NRVA02D-302X	CMF RESISTOR	3kΩ 1/10W D	
R5319	NRVA02D-472X	CMF RESISTOR	4.7kΩ 1/10W D	
R5325	QRE141J-8R2Y	C RESISTOR	8.2Ω 1/4W J	
△ R5326	QRZ9005-470X	FUSI RESISTOR	47Ω 1/4W G	
R5327	NRSA02J-103X	MG RESISTOR	10kΩ 1/10W J	
R5328	NRSA02J-471X	MG RESISTOR	470Ω 1/10W J	
R5329	NRSA02J-103X	MG RESISTOR	10kΩ 1/10W J	
R5330	NRSA02J-471X	MG RESISTOR	470Ω 1/10W J	
L5201	PELN1184	CHOKE COIL		
L5202	PELN1184	CHOKE COIL		
L5204	PELN1184	CHOKE COIL		
L5205	PELN1184	CHOKE COIL		
L5206	PELN1184	CHOKE COIL		
L5207	PELN1184	CHOKE COIL		
L5301	QQR0678-001Z	FERRITE BEADS		
L5302	QQR0678-001Z	FERRITE BEADS		
△ T5001	QQS0263-001	SW TRANSF		
B5301	NRSA02J-0R0X	MG RESISTOR	0Ω 1/10W J	
B5305	NRSA02J-0R0X	MG RESISTOR	0Ω 1/10W J	
△ CN5001	QGA7901C3-02	CONNECTOR	W-B (1-2)	
CN5301	QGB1231L1-15	CONNECTOR	B-B (1-15)	
CN5302	QGA2001C1-02	CONNECTOR	W-B (1-2)	
CN5303	QGA2501C1-04	CONNECTOR	W-B (1-4)	
CN5304	QGB1231L1-15	CONNECTOR	B-B (1-15)	
△ CP5301	QMFZ049-1R5Z-E	FUSE	1.5A 125V	
△ F5001	QMF51N2-1R6-J1	FUSE	1.6A AC250V	
FC5001	QNG0020-001Z	FUSE CLIP		
FC5002	QNG0020-001Z	FUSE CLIP		
△ LF5002	QQR0908-001	LINE FILTER		
△ VA5001	QAF0039-431Z	VARISTOR	430V	
W5501	NRSA02J-0R0X	MG RESISTOR	0Ω 1/10W J	

## DIGITAL BOARD ASSEMBLY <02>

Symbol No.	Part No.	Part Name	Description	Local
PW1	LPA10236-05C	DIGITAL BOARD ASSY		
IC1001	JCP8059	IC		
IC1002	HY57V161610DTC7	IC		
IC1002	or K4S161622H-TC80	IC		
IC1002	or MT48LC1M16A1TG8	IC		
IC1002	or HY57V161610DTC8	IC		
IC1002	or MT48LC1M16TG-7S	IC		
IC1201	MBPL65LM90TN	IC		
IC1202	SN74LVC373APW-X	IC(DIGITAL)		
IC1203	SN74LVC373APW-X	IC(DIGITAL)		
IC1401	DMN8652-B0	IC(DIGITAL)		
IC1404	SN74HCT08APW-X	IC		
IC1405	SN74LV08APW-X	IC		
IC1601	HY5DU561622CT-J	IC		
IC1602	HY5DU561622CT-J	IC		
IC1701	PQ015YZ01Z-X	IC		
IC1801	TSB41AB2PAP	IC		
Q1001	UN221E-X	TRANSTSTOR		
Q1001	or DTC144WKA-X	DIGI TRANSISTOR		
Q1001	or RT1N44HC-X	DIGI TRANSISTOR		
Q1002	2SA1037AK/QR/-X	TRANSISTOR		
Q1002	or 2SA1530A/QR/-X	TRANSISTOR		
Q1002	or 2SB709A/QR/-X	TRANSISTOR		
Q1003	2SA1037AK/QR/-X	TRANSISTOR		
Q1003	or 2SA1530A/QR/-X	TRANSISTOR		
Q1003	or 2SB709A/QR/-X	TRANSISTOR		
Q1004	2SA1037AK/QR/-X	TRANSISTOR		
Q1004	or 2SA1530A/QR/-X	TRANSISTOR		
Q1004	or 2SB709A/QR/-X	TRANSISTOR		
Q1005	2SA1037AK/QR/-X	TRANSISTOR		
Q1005	or 2SA1530A/QR/-X	TRANSISTOR		
Q1005	or 2SB709A/QR/-X	TRANSISTOR		
Q1008	UMZ1N-W	PAIR TRANSISTOR		
Q1008	or BC847PN-X	PAIR TRANSISTOR		
Q1008	or BC846PN-X	PAIR TRANSISTOR		
Q1009	2SC2412K/QRS/-X	TRANSISTOR		
Q1009	or 2SC3928A/QRS/-X	TRANSISTOR		
Q1009	or 2SD601A/QRS/-X	TRANSISTOR		
Q1010	2SC2412K/QRS/-X	TRANSISTOR		
Q1010	or 2SC3928A/QRS/-X	TRANSISTOR		
Q1010	or 2SD601A/QRS/-X	TRANSISTOR		
Q1011	2SC2412K/QRS/-X	TRANSISTOR		
Q1011	or 2SC3928A/QRS/-X	TRANSISTOR		
Q1011	or 2SD601A/QRS/-X	TRANSISTOR		
D1001	1SS355-X	SI DIODE		
D1001	or MA111-X	SI DIODE		
D1002	1SS355-X	SI DIODE		
D1002	or MA111-X	SI DIODE		
D1401	1SS355-X	SI DIODE		
D1401	or MA111-X	SI DIODE		
D1402	1SS355-X	SI DIODE		
D1402	or MA111-X	SI DIODE		
D1403	1SS355-X	SI DIODE		
D1403	or MA111-X	SI DIODE		
C1001	NBE20JM-226X	TA E CAPACITOR	22uF 6.3V M	
C1002	NBE20JM-106X	TA E CAPACITOR	10uF 6.3V M	
C1003	NCB31CK-104X	C CAPACITOR	0.1uF 16V K	
C1004	NCB31CK-104X	C CAPACITOR	0.1uF 16V K	
C1005	NCB31CK-104X	C CAPACITOR	0.1uF 16V K	
C1007	NCB31CK-104X	C CAPACITOR	0.1uF 16V K	
C1008	NCB31CK-104X	C CAPACITOR	0.1uF 16V K	
C1009	NCB31CK-104X	C CAPACITOR	0.1uF 16V K	
C1012	NCB31CK-104X	C CAPACITOR	0.1uF 16V K	
C1014	NCB31CK-104X	C CAPACITOR	0.1uF 16V K	
C1015	NCB31CK-104X	C CAPACITOR	0.1uF 16V K	
C1017	NCB31CK-104X	C CAPACITOR	0.1uF 16V K	
C1018	NCB31CK-104X	C CAPACITOR	0.1uF 16V K	
C1019	NCB31EK-103X	C CAPACITOR	0.01uF 25V K	
C1020	NCB31CK-104X	C CAPACITOR	0.1uF 16V K	
C1026	NCB31CK-104X	C CAPACITOR	0.1uF 16V K	
C1030	NCB31CK-104X	C CAPACITOR	0.1uF 16V K	
C1032	NCB31CK-104X	C CAPACITOR	0.1uF 16V K	

MODEL	MARK
DR-MV1SUC	A
DR-MV1SUS	B

△ Symbol No.	Part No.	Part Name	Description	Local	△ Symbol No.	Part No.	Part Name	Description	Local
C1033	NCB31CK-104X	C CAPACITOR	0.1uF 16V K		C1443	NCB31CK-104X	C CAPACITOR	0.1uF 16V K	
C1034	NCB31CK-104X	C CAPACITOR	0.1uF 16V K		C1444	NCB31CK-104X	C CAPACITOR	0.1uF 16V K	
C1035	NCB31CK-104X	C CAPACITOR	0.1uF 16V K		C1445	NCB31CK-104X	C CAPACITOR	0.1uF 16V K	
C1036	NCB31CK-104X	C CAPACITOR	0.1uF 16V K		C1446	NCB31CK-104X	C CAPACITOR	0.1uF 16V K	
C1038	NCB31CK-104X	C CAPACITOR	0.1uF 16V K		C1447	NCB31CK-104X	C CAPACITOR	0.1uF 16V K	
C1039	NCB31CK-104X	C CAPACITOR	0.1uF 16V K		C1448	NCB31EK-103X	C CAPACITOR	0.01uF 25V K	
C1041	NBE20JM-106X	TA E CAPACITOR	10uF 6.3V M		C1449	NCB31CK-104X	C CAPACITOR	0.1uF 16V K	
C1042	NCB31CK-104X	C CAPACITOR	0.1uF 16V K		C1450	NCB31CK-104X	C CAPACITOR	0.1uF 16V K	
C1043	NCB31CK-104X	C CAPACITOR	0.1uF 16V K		C1452	NCB31CK-104X	C CAPACITOR	0.1uF 16V K	
C1044	NCB31CK-104X	C CAPACITOR	0.1uF 16V K		C1453	NCB31CK-104X	C CAPACITOR	0.1uF 16V K	
C1045	NCB31CK-104X	C CAPACITOR	0.1uF 16V K		C1455	NCB31CK-104X	C CAPACITOR	0.1uF 16V K	
C1046	NCB31CK-104X	C CAPACITOR	0.1uF 16V K		C1457	NCB31CK-104X	C CAPACITOR	0.1uF 16V K	
C1047	NCB31CK-104X	C CAPACITOR	0.1uF 16V K		C1458	NCB31CK-104X	C CAPACITOR	0.1uF 16V K	
C1051	NBE20JM-106X	TA E CAPACITOR	10uF 6.3V M		C1601	NBAD0GM-227X	OS E CAPACITOR	220uF 2.5V M	
C1052	NCB31CK-104X	C CAPACITOR	0.1uF 16V K		C1602	NBAD0GM-227X	OS E CAPACITOR	220uF 2.5V M	
C1053	NCB31EK-103X	C CAPACITOR	0.01uF 25V K		C1605	NCB31CK-104X	C CAPACITOR	0.1uF 16V K	
C1054	NCB31CK-104X	C CAPACITOR	0.1uF 16V K		C1606	NCB31CK-104X	C CAPACITOR	0.1uF 16V K	
C1055	NCB31CK-104X	C CAPACITOR	0.1uF 16V K		C1607	NCB31CK-104X	C CAPACITOR	0.1uF 16V K	
C1056	NCB31CK-104X	C CAPACITOR	0.1uF 16V K		C1608	NCB31CK-104X	C CAPACITOR	0.1uF 16V K	
C1057	NCB31CK-104X	C CAPACITOR	0.1uF 16V K		C1609	NCB31CK-104X	C CAPACITOR	0.1uF 16V K	
C1059	NCB31CK-104X	C CAPACITOR	0.1uF 16V K		C1610	NCB31CK-104X	C CAPACITOR	0.1uF 16V K	
C1060	NCB31CK-104X	C CAPACITOR	0.1uF 16V K		C1611	NCB31CK-104X	C CAPACITOR	0.1uF 16V K	
C1061	NCB31CK-104X	C CAPACITOR	0.1uF 16V K		C1612	NCB31CK-104X	C CAPACITOR	0.1uF 16V K	
C1065	NCB20JM-475X	C CAPACITOR	4.7uF 6.3V M		C1613	NCB31CK-104X	C CAPACITOR	0.1uF 16V K	
C1077	NCB31CK-104X	C CAPACITOR	0.1uF 16V K		C1614	NCB31CK-104X	C CAPACITOR	0.1uF 16V K	
C1089	NCB31CK-104X	C CAPACITOR	0.1uF 16V K		C1615	NCB31CK-104X	C CAPACITOR	0.1uF 16V K	
C1090	NCB31CK-104X	C CAPACITOR	0.1uF 16V K		C1616	NCB31CK-104X	C CAPACITOR	0.1uF 16V K	
C1091	NCB31CK-104X	C CAPACITOR	0.1uF 16V K		C1617	NCB31CK-104X	C CAPACITOR	0.1uF 16V K	
C1092	NCB31CK-104X	C CAPACITOR	0.1uF 16V K		C1618	NCB31CK-104X	C CAPACITOR	0.1uF 16V K	
C1093	NCB31CK-104X	C CAPACITOR	0.1uF 16V K		C1619	NCB31CK-104X	C CAPACITOR	0.1uF 16V K	
C1094	NCB31CK-104X	C CAPACITOR	0.1uF 16V K		C1620	NCB31CK-104X	C CAPACITOR	0.1uF 16V K	
C1095	NBE20JM-106X	TA E CAPACITOR	10uF 6.3V M		C1621	NCB31CK-104X	C CAPACITOR	0.1uF 16V K	
C1096	NCB31CK-104X	C CAPACITOR	0.1uF 16V K		C1622	NCB31CK-104X	C CAPACITOR	0.1uF 16V K	
C1097	NCB31CK-104X	C CAPACITOR	0.1uF 16V K		C1623	NCB31CK-104X	C CAPACITOR	0.1uF 16V K	
C1098	NCB31CK-104X	C CAPACITOR	0.1uF 16V K		C1624	NCB31CK-104X	C CAPACITOR	0.1uF 16V K	
C1203	NCB31CK-104X	C CAPACITOR	0.1uF 16V K		C1625	NCB31CK-104X	C CAPACITOR	0.1uF 16V K	
C1204	NEH90JM-476X	E CAPACITOR	47uF 6.3V M		C1638	NCB31CK-104X	C CAPACITOR	0.1uF 16V K	
C1206	NCB31CK-104X	C CAPACITOR	0.1uF 16V K		C1640	NCB31CK-104X	C CAPACITOR	0.1uF 16V K	
C1207	NCB31CK-104X	C CAPACITOR	0.1uF 16V K		C1642	NCB31CK-104X	C CAPACITOR	0.1uF 16V K	
C1401	NCB31CK-104X	C CAPACITOR	0.1uF 16V K		C1644	NCB31CK-104X	C CAPACITOR	0.1uF 16V K	
C1402	NCB31CK-104X	C CAPACITOR	0.1uF 16V K		C1646	NCB31CK-104X	C CAPACITOR	0.1uF 16V K	
C1403	NCB31CK-104X	C CAPACITOR	0.1uF 16V K		C1648	NCB31CK-104X	C CAPACITOR	0.1uF 16V K	
C1404	NEHS0JM-107X	E CAPACITOR	100uF 6.3V M		C1650	NCB31CK-104X	C CAPACITOR	0.1uF 16V K	
C1405	NCB31CK-104X	C CAPACITOR	0.1uF 16V K		C1652	NCB31CK-104X	C CAPACITOR	0.1uF 16V K	
C1406	NCB31CK-104X	C CAPACITOR	0.1uF 16V K		C1654	NCB31CK-104X	C CAPACITOR	0.1uF 16V K	
C1407	NCB31CK-104X	C CAPACITOR	0.1uF 16V K		C1656	NCB31CK-104X	C CAPACITOR	0.1uF 16V K	
C1408	NCB31CK-104X	C CAPACITOR	0.1uF 16V K		C1658	NCB31CK-104X	C CAPACITOR	0.1uF 16V K	
C1409	NCB31CK-104X	C CAPACITOR	0.1uF 16V K		C1701	NCB31CK-104X	C CAPACITOR	0.1uF 16V K	
C1410	NCB31CK-104X	C CAPACITOR	0.1uF 16V K		C1702	NEHS0JM-107X	E CAPACITOR	100uF 6.3V M	
C1411	NEHS0JM-107X	E CAPACITOR	100uF 6.3V M		C1703	NCB31CK-104X	C CAPACITOR	0.1uF 16V K	
C1412	NCB31CK-104X	C CAPACITOR	0.1uF 16V K		C1704	NEHS0JM-107X	E CAPACITOR	100uF 6.3V M	
C1413	NEHS0JM-107X	E CAPACITOR	100uF 6.3V M		C1706	NCB31CK-104X	C CAPACITOR	0.1uF 16V K	
C1414	NCB31CK-104X	C CAPACITOR	0.1uF 16V K		C1707	NCB31CK-104X	C CAPACITOR	0.1uF 16V K	
C1416	NCB31CK-104X	C CAPACITOR	0.1uF 16V K		C1708	NBE40JM-476X	TA E CAPACITOR	47uF 6.3V M	
C1417	NCB31CK-104X	C CAPACITOR	0.1uF 16V K		C1710	NBE40JM-476X	TA E CAPACITOR	47uF 6.3V M	
C1418	NCB31CK-104X	C CAPACITOR	0.1uF 16V K		C1801	NCB30JK-105X	C CAPACITOR	1uF 6.3V K	
C1420	NBE20JM-106X	TA E CAPACITOR	10uF 6.3V M		C1802	NDC31HJ-271X	C CAPACITOR	270pF 50V J	
C1421	NCB31CK-104X	C CAPACITOR	0.1uF 16V K		C1803	NBE20JM-106X	TA E CAPACITOR	10uF 6.3V M	
C1422	NCB31CK-104X	C CAPACITOR	0.1uF 16V K		C1804	NCB31CK-104X	C CAPACITOR	0.1uF 16V K	
C1423	NCB31CK-104X	C CAPACITOR	0.1uF 16V K		C1805	NCB31CK-104X	C CAPACITOR	0.1uF 16V K	
C1424	NCB31CK-104X	C CAPACITOR	0.1uF 16V K		C1806	NBE20JM-106X	TA E CAPACITOR	10uF 6.3V M	
C1425	NCB31CK-104X	C CAPACITOR	0.1uF 16V K		C1807	NCB31CK-104X	C CAPACITOR	0.1uF 16V K	
C1426	NCB31CK-104X	C CAPACITOR	0.1uF 16V K		C1808	NDC31HJ-120X	C CAPACITOR	12pF 50V J	
C1427	NBE20JM-106X	TA E CAPACITOR	10uF 6.3V M		C1809	NDC31HJ-120X	C CAPACITOR	12pF 50V J	
C1428	NCB31CK-104X	C CAPACITOR	0.1uF 16V K		C1811	NCB31CK-104X	C CAPACITOR	0.1uF 16V K	
C1429	NCB31CK-104X	C CAPACITOR	0.1uF 16V K		C1812	NCB31CK-104X	C CAPACITOR	0.1uF 16V K	
C1430	NCB31CK-104X	C CAPACITOR	0.1uF 16V K		C2201	NCB31CK-104X	C CAPACITOR	0.1uF 16V K	
C1431	NCB31CK-104X	C CAPACITOR	0.1uF 16V K		C2202	NCB31CK-104X	C CAPACITOR	0.1uF 16V K	
C1432	NCB31CK-104X	C CAPACITOR	0.1uF 16V K						
C1433	NCB31CK-104X	C CAPACITOR	0.1uF 16V K		R1001	NRSA63D-221X	MG RESISTOR	220Ω 1/16W D	
C1435	NBE20JM-106X	TA E CAPACITOR	10uF 6.3V M		R1002	NRSA63J-0R0X	MG RESISTOR	0Ω 1/16W J	
C1436	NCB31CK-104X	C CAPACITOR	0.1uF 16V K		R1003	NRSA63J-0R0X	MG RESISTOR	0Ω 1/16W J	
C1437	NCB31CK-104X	C CAPACITOR	0.1uF 16V K		R1004	NRSA63J-0R0X	MG RESISTOR	0Ω 1/16W J	
C1438	NCB31CK-104X	C CAPACITOR	0.1uF 16V K		R1005	NRSA63J-103X	MG RESISTOR	10kΩ 1/16W J	
C1439	NCB31CK-104X	C CAPACITOR	0.1uF 16V K		R1006	NRSA63J-0R0X	MG RESISTOR	0Ω 1/16W J	
C1440	NCB31CK-104X	C CAPACITOR	0.1uF 16V K		R1007	NRSA63J-103X	MG RESISTOR	10kΩ 1/16W J	
C1441	NCB31CK-104X	C CAPACITOR	0.1uF 16V K		R1009	NRSA63J-103X	MG RESISTOR	10kΩ 1/16W J	
C1442	NCB31CK-104X	C CAPACITOR	0.1uF 16V K		R1012	NRSA63J-0R0X	MG RESISTOR	0Ω 1/16W J	



MODEL	MARK
DR-MV1SUC	A
DR-MV1SUS	B

△ Symbol No.	Part No.	Part Name	Description	Local	△ Symbol No.	Part No.	Part Name	Description	Local
R1013	NRSA02J-0R0X	MG RESISTOR	0Ω 1/10W J		R1430	NRSA63J-101X	MG RESISTOR	100Ω 1/16W J	
R1014	NRSA02J-0R0X	MG RESISTOR	0Ω 1/10W J		R1431	NRSA63J-101X	MG RESISTOR	100Ω 1/16W J	
R1015	NRSA02J-0R0X	MG RESISTOR	0Ω 1/10W J		R1434	NRSA63J-101X	MG RESISTOR	100Ω 1/16W J	
R1017	NRSA63J-0R0X	MG RESISTOR	0Ω 1/16W J		R1435	NRSA63J-101X	MG RESISTOR	100Ω 1/16W J	
R1018	NRSA63J-0R0X	MG RESISTOR	0Ω 1/16W J		R1436	NRSA63J-101X	MG RESISTOR	100Ω 1/16W J	
R1019	NRSA63J-0R0X	MG RESISTOR	0Ω 1/16W J		R1437	NRSA63J-0R0X	MG RESISTOR	0Ω 1/16W J	
R1021	NRSA63D-332X	MG RESISTOR	3.3kΩ 1/16W D		R1438	NRSA63J-101X	MG RESISTOR	100Ω 1/16W J	
R1022	NRSA63D-152X	MG RESISTOR	1.5kΩ 1/16W D		R1439	NRSA63J-101X	MG RESISTOR	100Ω 1/16W J	
R1024	NRSA63D-272X	MG RESISTOR	2.7kΩ 1/16W D		R1440	NRSA63J-101X	MG RESISTOR	100Ω 1/16W J	
R1027	NRSA63J-272X	MG RESISTOR	2.7kΩ 1/16W J		R1441	NRSA63J-103X	MG RESISTOR	10kΩ 1/16W J	
R1028	NRSA63J-272X	MG RESISTOR	2.7kΩ 1/16W J		R1443	NRSA63J-472X	MG RESISTOR	4.7kΩ 1/16W J	
R1029	NRSA63J-0R0X	MG RESISTOR	0Ω 1/16W J		R1444	NRSA63J-472X	MG RESISTOR	4.7kΩ 1/16W J	
R1030	NRSA63J-103X	MG RESISTOR	10kΩ 1/16W J		R1445	NRSA63J-101X	MG RESISTOR	100Ω 1/16W J	
R1031	NRSA63J-103X	MG RESISTOR	10kΩ 1/16W J		R1446	NRSA63J-101X	MG RESISTOR	100Ω 1/16W J	
R1032	NRSA63J-103X	MG RESISTOR	10kΩ 1/16W J		R1447	NRSA63J-101X	MG RESISTOR	100Ω 1/16W J	
R1033	NRSA63J-471X	MG RESISTOR	470Ω 1/16W J		R1448	NRSA63J-101X	MG RESISTOR	100Ω 1/16W J	
R1034	NRSA63J-103X	MG RESISTOR	10kΩ 1/16W J		R1449	NRSA63J-101X	MG RESISTOR	100Ω 1/16W J	
R1035	NQR0129-002X	FERRITE BEADS			R1450	NRSA63J-101X	MG RESISTOR	100Ω 1/16W J	
R1036	NRSA63J-102X	MG RESISTOR	1kΩ 1/16W J		R1451	NRSA63J-101X	MG RESISTOR	100Ω 1/16W J	
R1037	NRSA63D-101X	MG RESISTOR	100Ω 1/16W D		R1452	NRSA63J-101X	MG RESISTOR	100Ω 1/16W J	
R1038	NQR0129-002X	FERRITE BEADS			R1453	NRSA63J-101X	MG RESISTOR	100Ω 1/16W J	
R1039	NRSA63J-102X	MG RESISTOR	1kΩ 1/16W J		R1458	NRSA63J-101X	MG RESISTOR	100Ω 1/16W J	
R1040	NRSA63D-101X	MG RESISTOR	100Ω 1/16W D		R1459	NRSA63J-101X	MG RESISTOR	100Ω 1/16W J	
R1041	NQR0129-002X	FERRITE BEADS			R1460	NRSA63J-101X	MG RESISTOR	100Ω 1/16W J	
R1042	NRSA63J-102X	MG RESISTOR	1kΩ 1/16W J		R1461	NRSA63J-101X	MG RESISTOR	100Ω 1/16W J	
R1043	NRSA63D-151X	MG RESISTOR	150Ω 1/16W D		R1462	NRSA63J-101X	MG RESISTOR	100Ω 1/16W J	
R1044	NQR0129-002X	FERRITE BEADS			R1465	NRSA63J-101X	MG RESISTOR	100Ω 1/16W J	
R1045	NRSA63J-102X	MG RESISTOR	1kΩ 1/16W J		R1466	NRSA63J-101X	MG RESISTOR	100Ω 1/16W J	
R1046	NRSA63J-332X	MG RESISTOR	3.3kΩ 1/16W J		R1467	NRSA63J-101X	MG RESISTOR	100Ω 1/16W J	
R1047	NRSA63D-221X	MG RESISTOR	220Ω 1/16W D		R1468	NRSA63J-101X	MG RESISTOR	100Ω 1/16W J	
R1050	NRSA63J-152X	MG RESISTOR	1.5kΩ 1/16W J		R1469	NRSA63J-102X	MG RESISTOR	1kΩ 1/16W J	
R1054	NRSA63D-332X	MG RESISTOR	3.3kΩ 1/16W D		R1470	NRSA63J-102X	MG RESISTOR	1kΩ 1/16W J	
R1056	NRSA63J-222X	MG RESISTOR	2.2kΩ 1/16W J		R1471	NRSA63J-101X	MG RESISTOR	100Ω 1/16W J	
R1057	NRSA63J-330X	MG RESISTOR	33Ω 1/16W J		R1472	NRSA63J-0R0X	MG RESISTOR	0Ω 1/16W J	
R1059	NRSA63J-471X	MG RESISTOR	470Ω 1/16W J		R1473	NRSA63J-101X	MG RESISTOR	100Ω 1/16W J	
R1060	NRSA63J-223X	MG RESISTOR	22kΩ 1/16W J		R1474	NRSA63J-101X	MG RESISTOR	100Ω 1/16W J	
R1061	NRSA63J-223X	MG RESISTOR	22kΩ 1/16W J		R1475	NRSA63J-101X	MG RESISTOR	100Ω 1/16W J	
R1065	NRSA63J-121X	MG RESISTOR	120Ω 1/16W J		R1476	NRSA63J-101X	MG RESISTOR	100Ω 1/16W J	
R1066	NRSA63J-101X	MG RESISTOR	100Ω 1/16W J		R1477	NRSA63J-101X	MG RESISTOR	100Ω 1/16W J	
R1067	NRSA63J-121X	MG RESISTOR	120Ω 1/16W J		R1478	NRSA63J-101X	MG RESISTOR	100Ω 1/16W J	
R1068	NRSA63D-222X	MG RESISTOR	2.2kΩ 1/16W D		R1479	NRSA63J-101X	MG RESISTOR	100Ω 1/16W J	
R1069	NRSA63D-222X	MG RESISTOR	2.2kΩ 1/16W D		R1480	NRSA63J-0R0X	MG RESISTOR	0Ω 1/16W J	
R1070	NRSA63D-122X	MG RESISTOR	1.2kΩ 1/16W D		R1481	NRSA63J-0R0X	MG RESISTOR	0Ω 1/16W J	
R1071	NRSA63D-152X	MG RESISTOR	1.5kΩ 1/16W D		R1482	NRSA63J-0R0X	MG RESISTOR	0Ω 1/16W J	
R1072	NRSA63J-0R0X	MG RESISTOR	0Ω 1/16W J		R1491	NRSA63J-102X	MG RESISTOR	1kΩ 1/16W J	
R1216	NRSA63J-101X	MG RESISTOR	100Ω 1/16W J		R1493	NRSA63J-0R0X	MG RESISTOR	0Ω 1/16W J	
R1217	NRSA63J-101X	MG RESISTOR	100Ω 1/16W J		R1496	NRSA63J-103X	MG RESISTOR	10kΩ 1/16W J	
R1218	NRSA63J-101X	MG RESISTOR	100Ω 1/16W J		R1497	NRSA63J-103X	MG RESISTOR	10kΩ 1/16W J	
R1219	NRSA63J-101X	MG RESISTOR	100Ω 1/16W J		R1498	NRSA63J-103X	MG RESISTOR	10kΩ 1/16W J	
R1220	NRSA63J-101X	MG RESISTOR	100Ω 1/16W J		R1601	NRSA63J-100X	MG RESISTOR	10Ω 1/16W J	
R1221	NRSA63J-101X	MG RESISTOR	100Ω 1/16W J		R1602	NRSA63J-100X	MG RESISTOR	10Ω 1/16W J	
R1222	NRSA63J-0R0X	MG RESISTOR	0Ω 1/16W J		R1603	NRSA63J-100X	MG RESISTOR	10Ω 1/16W J	
R1223	NRSA63J-472X	MG RESISTOR	4.7kΩ 1/16W J		R1604	NRSA63J-100X	MG RESISTOR	10Ω 1/16W J	
R1224	NRSA63J-472X	MG RESISTOR	4.7kΩ 1/16W J		R1605	NRSA63J-470X	MG RESISTOR	47Ω 1/16W J	
R1225	NRSA63J-103X	MG RESISTOR	10kΩ 1/16W J		R1606	NRSA63J-470X	MG RESISTOR	47Ω 1/16W J	
R1226	NRSA63J-472X	MG RESISTOR	4.7kΩ 1/16W J		R1607	NRSA63J-470X	MG RESISTOR	47Ω 1/16W J	
R1227	NRSA63J-101X	MG RESISTOR	100Ω 1/16W J		R1608	NRSA63J-470X	MG RESISTOR	47Ω 1/16W J	
R1228	NRSA63J-101X	MG RESISTOR	100Ω 1/16W J		R1613	NRSA63J-0R0X	MG RESISTOR	0Ω 1/16W J	
R1229	NRSA63J-472X	MG RESISTOR	4.7kΩ 1/16W J		R1614	NRSA63J-0R0X	MG RESISTOR	0Ω 1/16W J	
R1230	NRSA63J-472X	MG RESISTOR	4.7kΩ 1/16W J		R1615	NRSA63J-0R0X	MG RESISTOR	0Ω 1/16W J	
R1231	NRSA63J-472X	MG RESISTOR	4.7kΩ 1/16W J		R1616	NRSA63J-0R0X	MG RESISTOR	0Ω 1/16W J	
R1401	NRSA63F-1181X	MG RESISTOR	1.18kΩ 1/16W F		R1617	NRSA63J-270X	MG RESISTOR	27Ω 1/16W J	
R1402	NRSA63J-0R0X	MG RESISTOR	0Ω 1/16W J		R1618	NRSA63J-270X	MG RESISTOR	27Ω 1/16W J	
R1408	NRSA63J-102X	MG RESISTOR	1kΩ 1/16W J		R1619	NRSA63J-101X	MG RESISTOR	100Ω 1/16W J	
R1409	NRSA63J-103X	MG RESISTOR	10kΩ 1/16W J		R1620	NRSA63J-101X	MG RESISTOR	100Ω 1/16W J	
R1410	NRSA63J-103X	MG RESISTOR	10kΩ 1/16W J		R1621	NRSA63J-270X	MG RESISTOR	27Ω 1/16W J	
R1411	NRSA63J-101X	MG RESISTOR	100Ω 1/16W J		R1622	NRSA63J-270X	MG RESISTOR	27Ω 1/16W J	
R1412	NRSA63J-103X	MG RESISTOR	10kΩ 1/16W J		R1623	NRSA63J-270X	MG RESISTOR	27Ω 1/16W J	
R1413	NRSA63J-103X	MG RESISTOR	10kΩ 1/16W J		R1624	NRSA63J-270X	MG RESISTOR	27Ω 1/16W J	
R1414	NRSA63J-102X	MG RESISTOR	1kΩ 1/16W J		R1625	NRSA63J-101X	MG RESISTOR	100Ω 1/16W J	
R1415	NRSA63J-102X	MG RESISTOR	1kΩ 1/16W J		R1626	NRSA63J-101X	MG RESISTOR	100Ω 1/16W J	
R1416	NRSA63J-102X	MG RESISTOR	1kΩ 1/16W J		R1627	NRSA63J-270X	MG RESISTOR	27Ω 1/16W J	
R1417	NRSA63J-102X	MG RESISTOR	1kΩ 1/16W J		R1628	NRSA63J-270X	MG RESISTOR	27Ω 1/16W J	
R1419	NRSA63J-101X	MG RESISTOR	100Ω 1/16W J		R1642	NRSA63J-100X	MG RESISTOR	10Ω 1/16W J	
R1420	NRSA63J-101X	MG RESISTOR	100Ω 1/16W J		R1644	NRSA63J-470X	MG RESISTOR	47Ω 1/16W J	
R1427	NRSA63J-101X	MG RESISTOR	100Ω 1/16W J		R1649	NRSA63J-101X	MG RESISTOR	100Ω 1/16W J	
R1428	NRSA63J-101X	MG RESISTOR	100Ω 1/16W J		R1650	NRSA63J-101X	MG RESISTOR	100Ω 1/16W J	
R1429	NRSA63J-101X	MG RESISTOR	100Ω 1/16W J		R1651	NRSA63J-101X	MG RESISTOR	100Ω 1/16W J	

MODEL	MARK
DR-MV1SUC	A
DR-MV1SUS	B

Symbol No.	Part No.	Part Name	Description	Local	Symbol No.	Part No.	Part Name	Description	Local
R1652	NRSA63J-101X	MG RESISTOR	100Ω 1/16W J		RA1611	NRZ0040-220X	NET RESISTOR	22Ω 1/16W J x4	
R1653	NRSA63J-0R0X	MG RESISTOR	0Ω 1/16W J		RA1612	NRZ0040-220X	NET RESISTOR	22Ω 1/16W J x4	
R1654	NRSA63J-0R0X	MG RESISTOR	0Ω 1/16W J		RA1613	NRZ0040-220X	NET RESISTOR	22Ω 1/16W J x4	
R1655	NRSA63J-0R0X	MG RESISTOR	0Ω 1/16W J		RA1614	NRZ0040-220X	NET RESISTOR	22Ω 1/16W J x4	
R1656	NRSA63J-0R0X	MG RESISTOR	0Ω 1/16W J		RA1615	NRZ0040-220X	NET RESISTOR	22Ω 1/16W J x4	
R1657	NRSA63J-220X	MG RESISTOR	22Ω 1/16W J		RA1616	NRZ0040-220X	NET RESISTOR	22Ω 1/16W J x4	
R1658	NRSA63J-220X	MG RESISTOR	22Ω 1/16W J		RA1617	NRZ0040-101X	NET RESISTOR	100Ω 1/16W J x4	
R1659	NRSA63J-220X	MG RESISTOR	22Ω 1/16W J		RA1618	NRZ0040-101X	NET RESISTOR	100Ω 1/16W J x4	
R1660	NRSA63J-220X	MG RESISTOR	22Ω 1/16W J		RA1619	NRZ0040-101X	NET RESISTOR	100Ω 1/16W J x4	
R1701	NRSA63J-271X	MG RESISTOR	270Ω 1/16W J		RA1620	NRZ0040-101X	NET RESISTOR	100Ω 1/16W J x4	
R1702	NRSA63J-102X	MG RESISTOR	1kΩ 1/16W J		RA1621	NRZ0040-101X	NET RESISTOR	100Ω 1/16W J x4	
R1703	NRSA63D-222X	MG RESISTOR	2.2kΩ 1/16W D		RA1622	NRZ0040-101X	NET RESISTOR	100Ω 1/16W J x4	
R1704	NRSA63D-222X	MG RESISTOR	2.2kΩ 1/16W D		RA1623	NRZ0040-101X	NET RESISTOR	100Ω 1/16W J x4	
R1801	NRSA63J-0R0X	MG RESISTOR	0Ω 1/16W J		RA1624	NRZ0040-101X	NET RESISTOR	100Ω 1/16W J x4	
R1802	NRSA63J-0R0X	MG RESISTOR	0Ω 1/16W J		RA1625	NRZ0040-100X	NET RESISTOR	10Ω 1/16W J x4	
R1803	NRSA63J-103X	MG RESISTOR	10kΩ 1/16W J		RA1626	NRZ0040-100X	NET RESISTOR	10Ω 1/16W J x4	
R1804	NRSA63J-103X	MG RESISTOR	10kΩ 1/16W J		RA1627	NRZ0040-100X	NET RESISTOR	10Ω 1/16W J x4	
R1805	NRSA63J-0R0X	MG RESISTOR	0Ω 1/16W J		RA1628	NRZ0040-100X	NET RESISTOR	10Ω 1/16W J x4	
R1807	NRSA63J-103X	MG RESISTOR	10kΩ 1/16W J		RA1629	NRZ0040-470X	NET RESISTOR	47Ω 1/16W J x4	
R1809	NRSA63J-103X	MG RESISTOR	10kΩ 1/16W J		RA1630	NRZ0040-470X	NET RESISTOR	47Ω 1/16W J x4	
R1810	NRSA63J-394X	MG RESISTOR	390kΩ 1/16W J		RA1631	NRZ0040-470X	NET RESISTOR	47Ω 1/16W J x4	
R1812	NRSA63J-0R0X	MG RESISTOR	0Ω 1/16W J		RA1632	NRZ0040-470X	NET RESISTOR	47Ω 1/16W J x4	
R1813	NRSA63J-560X	MG RESISTOR	56Ω 1/16W J		RA1801	NRZ0034-103W	NET RESISTOR	10kΩ 1/32W J	
R1814	NRSA63J-560X	MG RESISTOR	56Ω 1/16W J		RA1802	NRZ0034-103W	NET RESISTOR	10kΩ 1/32W J	
R1815	NRSA63J-560X	MG RESISTOR	56Ω 1/16W J		RA2201	NRZ0040-0R0X	NET RESISTOR	0Ω 1/16W J x4	
R1816	NRSA63J-560X	MG RESISTOR	56Ω 1/16W J		RA2202	NRZ0040-0R0X	NET RESISTOR	0Ω 1/16W J x4	
R1817	NRSA63J-512X	MG RESISTOR	5.1kΩ 1/16W J		RA2203	NRZ0040-0R0X	NET RESISTOR	0Ω 1/16W J x4	
R1818	NRSA63D-562X	MG RESISTOR	5.6kΩ 1/16W D		RA2204	NRZ0040-0R0X	NET RESISTOR	0Ω 1/16W J x4	
R1819	NRSA63D-751X	MG RESISTOR	750Ω 1/16W D		RA2205	NRZ0040-0R0X	NET RESISTOR	0Ω 1/16W J x4	
R1820	NRSA63J-103X	MG RESISTOR	10kΩ 1/16W J		RA2206	NRZ0040-0R0X	NET RESISTOR	0Ω 1/16W J x4	
R1821	NRSA63J-102X	MG RESISTOR	1kΩ 1/16W J		RA2207	NRZ0040-0R0X	NET RESISTOR	0Ω 1/16W J x4	
R1822	NRSA63J-0R0X	MG RESISTOR	0Ω 1/16W J		RA2208	NRZ0040-330X	NET RESISTOR	33Ω 1/16W J x4	
R2201	NRSA63J-103X	MG RESISTOR	10kΩ 1/16W J		RA2209	NRZ0040-330X	NET RESISTOR	33Ω 1/16W J x4	
R2202	NRSA63J-562X	MG RESISTOR	5.6kΩ 1/16W J		RA2210	NRZ0040-330X	NET RESISTOR	33Ω 1/16W J x4	
R2203	NRSA63J-472X	MG RESISTOR	4.7kΩ 1/16W J		RA2211	NRZ0040-330X	NET RESISTOR	33Ω 1/16W J x4	
R2204	NRSA63J-330X	MG RESISTOR	33Ω 1/16W J		L1004	NQL144K-100X	P COIL	0.30Ω 10uH K	
R2205	NRSA63J-820X	MG RESISTOR	82Ω 1/16W J		L1801	NQL144K-100X	P COIL	0.30Ω 10uH K	
R2206	NRSA63J-220X	MG RESISTOR	22Ω 1/16W J		T1801	NQR0444-001X	CHOKE COIL		
R2207	NRSA63J-220X	MG RESISTOR	22Ω 1/16W J						
R2208	NRSA63J-820X	MG RESISTOR	82Ω 1/16W J		B1001	NRSA02J-0R0X	MG RESISTOR	0Ω 1/10W J	
R2209	NRSA63J-220X	MG RESISTOR	22Ω 1/16W J		B1007	NRSA02J-0R0X	MG RESISTOR	0Ω 1/10W J	
R2210	NRSA63J-820X	MG RESISTOR	82Ω 1/16W J		B1008	NQR0339-001X	FERRITE BEADS		
R2211	NRSA63J-330X	MG RESISTOR	33Ω 1/16W J		B1204	NRSA63J-0R0X	MG RESISTOR	0Ω 1/16W J	
R2212	NRSA63J-330X	MG RESISTOR	33Ω 1/16W J		B1208	NRSA63J-0R0X	MG RESISTOR	0Ω 1/16W J	
R2213	NRSA63J-330X	MG RESISTOR	33Ω 1/16W J		B1802	NRSA02J-0R0X	MG RESISTOR	0Ω 1/10W J	
R2214	NRSA63J-330X	MG RESISTOR	33Ω 1/16W J		CN1001	QGB2027L6-28X	CONNECTOR	B-B (1-28)	
R2215	NRSA63J-330X	MG RESISTOR	33Ω 1/16W J		CN1002	QGB2027L6-28X	CONNECTOR	B-B (1-28)	
RA1001	NRZ0040-0R0X	NET RESISTOR	0Ω 1/16W J x4		CN1202	QGF0508F1-36X	CONNECTOR	FFC/FPC (1-36)	
RA1002	NRZ0040-0R0X	NET RESISTOR	0Ω 1/16W J x4		CN1403	QGF1016C2-04W	CONNECTOR	FFC/FPC (1-4)	
RA1003	NRZ0034-103W	NET RESISTOR	10kΩ 1/32W J		CN1404	QGF1016F2-04W	CONNECTOR	FFC/FPC (1-4)	
RA1004	NRZ0034-103W	NET RESISTOR	10kΩ 1/32W J		CN1801	QGB2027L1-10X	CONNECTOR	B-B (1-10)	
RA1005	NRZ0034-103W	NET RESISTOR	10kΩ 1/32W J		CN2201	QGF0539C1-40W	CONNECTOR	FFC/FPC (1-40)	
RA1006	NRZ0034-103W	NET RESISTOR	10kΩ 1/32W J		K1001	NQR0339-001X	FERRITE BEADS		
RA1201	NRZ0034-103W	NET RESISTOR	10kΩ 1/32W J		K1002	NRSA63J-0R0X	MG RESISTOR	0Ω 1/16W J	
RA1202	NRZ0034-103W	NET RESISTOR	10kΩ 1/32W J		K1003	NQR0129-002X	FERRITE BEADS		
RA1203	NRZ0034-103W	NET RESISTOR	10kΩ 1/32W J		K1004	NRSA63J-0R0X	MG RESISTOR	0Ω 1/16W J	
RA1204	NRZ0034-103W	NET RESISTOR	10kΩ 1/32W J		K1005	NQR0129-002X	FERRITE BEADS		
RA1401	NRZ0040-101X	NET RESISTOR	100Ω 1/16W J x4		K1006	NRSA63J-0R0X	MG RESISTOR	0Ω 1/16W J	
RA1402	NRZ0040-101X	NET RESISTOR	100Ω 1/16W J x4		K1007	NRSA63J-0R0X	MG RESISTOR	0Ω 1/16W J	
RA1403	NRZ0040-101X	NET RESISTOR	100Ω 1/16W J x4		K1008	NRSA63J-0R0X	MG RESISTOR	0Ω 1/16W J	
RA1404	NRZ0040-101X	NET RESISTOR	100Ω 1/16W J x4		K1009	NRSA63J-0R0X	MG RESISTOR	0Ω 1/16W J	
RA1405	NRZ0034-101W	NET RESISTOR	100Ω 1/32W J		K1010	NQR0129-002X	FERRITE BEADS		
RA1406	NRZ0034-101W	NET RESISTOR	100Ω 1/32W J		K1011	NQR0129-002X	FERRITE BEADS		
RA1407	NRZ0034-101W	NET RESISTOR	100Ω 1/32W J		K1012	NQR0129-002X	FERRITE BEADS		
RA1408	NRZ0034-101W	NET RESISTOR	100Ω 1/32W J		K1013	NQR0129-002X	FERRITE BEADS		
RA1409	NRZ0034-101W	NET RESISTOR	100Ω 1/32W J		K1014	NQR0129-002X	FERRITE BEADS		
RA1410	NRZ0034-101W	NET RESISTOR	100Ω 1/32W J		K1015	NQR0129-002X	FERRITE BEADS		
RA1411	NRZ0034-101W	NET RESISTOR	100Ω 1/32W J		K1016	NQR0129-002X	FERRITE BEADS		
RA1601	NRZ0040-101X	NET RESISTOR	100Ω 1/16W J x4		K1017	NQR0129-002X	FERRITE BEADS		
RA1602	NRZ0040-101X	NET RESISTOR	100Ω 1/16W J x4		K1018	NQR0129-002X	FERRITE BEADS		
RA1603	NRZ0040-101X	NET RESISTOR	100Ω 1/16W J x4		K1019	NRSA02J-0R0X	MG RESISTOR	0Ω 1/10W J	
RA1604	NRZ0040-101X	NET RESISTOR	100Ω 1/16W J x4		K1020	NQR0129-002X	FERRITE BEADS		
RA1605	NRZ0040-101X	NET RESISTOR	100Ω 1/16W J x4		K1201	NRSA63J-0R0X	MG RESISTOR	0Ω 1/16W J	
RA1606	NRZ0040-101X	NET RESISTOR	100Ω 1/16W J x4		K1401	NRSA02J-0R0X	MG RESISTOR	0Ω 1/10W J	
RA1607	NRZ0040-101X	NET RESISTOR	100Ω 1/16W J x4		K1402	NRSA02J-0R0X	MG RESISTOR	0Ω 1/10W J	
RA1608	NRZ0040-101X	NET RESISTOR	100Ω 1/16W J x4		K1403	NRSA02J-0R0X	MG RESISTOR	0Ω 1/10W J	
RA1609	NRZ0040-220X	NET RESISTOR	22Ω 1/16W J x4		K1404	NRSA02J-0R0X	MG RESISTOR	0Ω 1/10W J	
RA1610	NRZ0040-220X	NET RESISTOR	22Ω 1/16W J x4						

MODEL	MARK
DR-MV1SUC	A
DR-MV1SUS	B

△ Symbol No.	Part No.	Part Name	Description	Local	△ Symbol No.	Part No.	Part Name	Description	Local
K1406	NRSA02J-0R0X	MG RESISTOR	0Ω 1/10W J		Q506	2SA1576A/QR/-X	TRANSISTOR		
K1407	NRSA02J-0R0X	MG RESISTOR	0Ω 1/10W J		Q506	or 2PA1576/R/-X	TRANSISTOR		
K1408	NRSA02J-0R0X	MG RESISTOR	0Ω 1/10W J		Q506	or 2SB1218A/QR/-X	TRANSISTOR		
K1701	NRSA02J-0R0X	MG RESISTOR	0Ω 1/10W J		Q506	or 2SA1602A/E/-X	TRANSISTOR		
K1702	NRSA02J-0R0X	MG RESISTOR	0Ω 1/10W J		Q2001	2SC4081/QRS/-X	TRANSISTOR		
K1801	NRSA02J-0R0X	MG RESISTOR	0Ω 1/10W J		Q2001	or 2SD1819A/QRS/-X	TRANSISTOR		
K2201	NQR0129-002X	FERRITE BEADS			Q2001	or 2PC4081/R/-X	TRANSISTOR		
K2202	NQR0129-002X	FERRITE BEADS			Q2001	or 2SC4154/EF/-X	TRANSISTOR		
K2203	NQR0129-002X	FERRITE BEADS			Q2002	2SC4081/QRS/-X	TRANSISTOR		
K2204	NQR0129-002X	FERRITE BEADS			Q2002	or 2SD1819A/QRS/-X	TRANSISTOR		
K2205	NQR0129-002X	FERRITE BEADS			Q2002	or 2PC4081/R/-X	TRANSISTOR		
K2206	NQR0129-002X	FERRITE BEADS			Q2002	or 2SC4154/EF/-X	TRANSISTOR		
K2207	NQR0129-002X	FERRITE BEADS			Q2003	DTA144WUA-X	DIGI TRANSISTOR		
K2208	NQR0129-002X	FERRITE BEADS			Q2003	or UN511E-X	DIGI TRANSISTOR		
K2209	NQR0129-002X	FERRITE BEADS			Q2003	or PDTA144WU-X	DIGI TRANSISTOR		
K2210	NQR0129-002X	FERRITE BEADS			Q2003	or RN2309-X	DIGI TRANSISTOR		
K2211	NQR0129-002X	FERRITE BEADS			Q2003	or RT1P44HM-X	DIGI TRANSISTOR		
K2212	NQR0129-002X	FERRITE BEADS			Q2051	2SC4081/QRS/-X	TRANSISTOR		
K2213	NQR0129-002X	FERRITE BEADS			Q2051	or 2SD1819A/QRS/-X	TRANSISTOR		
K2214	NQR0129-002X	FERRITE BEADS			Q2051	or 2PC4081/R/-X	TRANSISTOR		
K2215	NQR0129-002X	FERRITE BEADS			Q2051	or 2SC4154/EF/-X	TRANSISTOR		
K2216	NQR0129-002X	FERRITE BEADS			Q2052	2SA1576A/QR/-X	TRANSISTOR		
K2217	NQR0129-002X	FERRITE BEADS			Q2052	or 2SB1218A/QR/-X	TRANSISTOR		
K2218	NQR0129-002X	FERRITE BEADS			Q2052	or 2PA1576/R/-X	TRANSISTOR		
K2219	NQR0129-002X	FERRITE BEADS			Q2053	DTC144WUA-X	DIGI TRANSISTOR		
K2220	NQR0129-002X	FERRITE BEADS			Q2053	or PDTA144WU-X	DIGI TRANSISTOR		
K2221	NQR0129-002X	FERRITE BEADS			Q2053	or UN521E-X	DIGI TRANSISTOR		
LC1401	NQR0415-002X	EMI FILTER	1uF 16V Z		Q2053	or RN1309-X	DIGI TRANSISTOR		
LC1402	NQR0415-002X	EMI FILTER	1uF 16V Z		Q2053	or RT1N44HM-X	DIGI TRANSISTOR		
LC1403	NQR0415-002X	EMI FILTER	1uF 16V Z		Q2054	2SA1576A/QR/-X	TRANSISTOR		
OT1	LC41656-001A	COOLING SHEET			Q2054	or 2SB1218A/QR/-X	TRANSISTOR		
SD1	LP21293-001A	SHIELD FRAME(DIGITAL)			Q2054	or 2PA1576/R/-X	TRANSISTOR		
X1401	NAX0580-001X	CXO	27.0000MHz		Q2055	DTC144WUA-X	DIGI TRANSISTOR		
X1801	NAX0666-001X	CRYSTAL	24.576000MHz		Q2055	or PDTA144WU-X	DIGI TRANSISTOR		

### MAIN BOARD ASSEMBLY <03>

△ Symbol No.	Part No.	Part Name	Description	Local	△ Symbol No.	Part No.	Part Name	Description	Local
PW1	LPA10238-03B	MAIN BOARD ASSY		A	Q2201	or UN511E-X	DIGI TRANSISTOR		
PW1	LPA10238-01B	MAIN BOARD ASSY		B	Q2201	or RN2309-X	DIGI TRANSISTOR		
IC1	JCP8060-NVA	IC			Q2201	or RT1P44HM-X	DIGI TRANSISTOR		
IC501	JCP8038-I	IC			Q2202	DTC144WUA-X	DIGI TRANSISTOR		
IC501	or JCP8038	IC			Q2202	or PDTA144WU-X	DIGI TRANSISTOR		
△ IC2201	AN3663FBP	IC			Q2201	or UN511E-X	DIGI TRANSISTOR		
IC2602	BU4052BCF-X	IC			Q2201	or RN2309-X	DIGI TRANSISTOR		
IC2602	or CD4052BM-X	IC			Q2201	or RT1P44HM-X	DIGI TRANSISTOR		
IC2603	BA15218F-XE	IC			Q2202	DTC144WUA-X	DIGI TRANSISTOR		
IC2604	BU4052BCF-X	IC			Q2202	or PDTA144WU-X	DIGI TRANSISTOR		
IC2604	or CD4052BM-X	IC			Q2202	or UN521E-X	DIGI TRANSISTOR		
IC2605	BA15218F-XE	IC			Q2202	or RN1309-X	DIGI TRANSISTOR		
IC3001	HD6432194SAD72F	IC(MCU)			Q2202	or RT1N44HM-X	DIGI TRANSISTOR		
IC3001	or HD64F2194CFD72	IC(MCU)			Q2203	2SC4081/QRS/-X	TRANSISTOR		
IC3002	IC-PST3427U-X	IC			Q2203	or 2PC4081/R/-X	TRANSISTOR		
IC3003	LPN0878-003A-02	IC(EEPROM)	*(REFER TO BELOW)	A	Q2203	or 2SD1819A/QRS/-X	TRANSISTOR		
IC3003	LPN0878-001C-02	IC(EEPROM)	*(REFER TO BELOW)	B	Q2203	or 2SC4154/EF/-X	TRANSISTOR		
IC3003	or CAT24WC08JI-X	IC			Q2204	2SC4081/QRS/-X	TRANSISTOR		
IC3003	or BR24C08F-X	IC			Q2204	or 2PC4081/R/-X	TRANSISTOR		
IC3003	or X24C08S-X	IC			Q2204	or 2SD1819A/QRS/-X	TRANSISTOR		
IC3601	BU2090FS-X	IC			Q2204	or 2SC4154/EF/-X	TRANSISTOR		
IC7502	74HC4053D-X	IC			Q2601	2SC4081/QRS/-X	TRANSISTOR		
Q503	2SC4081/QRS/-X	TRANSISTOR			Q2601	or 2PC4081/R/-X	TRANSISTOR		
Q503	or 2PC4081/R/-X	TRANSISTOR			Q2601	or 2SD1819A/QRS/-X	TRANSISTOR		
Q503	or 2SD1819A/QRS/-X	TRANSISTOR			Q2601	or 2SC4154/EF/-X	TRANSISTOR		
Q503	or 2SC4154/EF/-X	TRANSISTOR			Q2602	2SC4081/QRS/-X	TRANSISTOR		
Q504	2SA1576A/QR/-X	TRANSISTOR			Q2602	or 2PC4081/R/-X	TRANSISTOR		
Q504	or 2PA1576/R/-X	TRANSISTOR			Q2602	or 2SD1819A/QRS/-X	TRANSISTOR		
Q504	or 2SB1218A/QR/-X	TRANSISTOR			Q2602	or 2SC4154/EF/-X	TRANSISTOR		
Q504	or 2SA1602A/E/-X	TRANSISTOR			Q2603	DTA144WUA-X	DIGI TRANSISTOR		
Q505	2SA1576A/QR/-X	TRANSISTOR			Q2603	or PDTA144WU-X	DIGI TRANSISTOR		
Q505	or 2PA1576/R/-X	TRANSISTOR			Q2603	or UN511E-X	DIGI TRANSISTOR		
Q505	or 2PA1576/R/-X	TRANSISTOR			Q2603	or RN2309-X	DIGI TRANSISTOR		
Q505	or 2SB1218A/QR/-X	TRANSISTOR			Q2603	or RT1P44HM-X	DIGI TRANSISTOR		
Q505	or 2SA1602A/E/-X	TRANSISTOR			Q3002	PTZ-NV16A	IC(PHOTO SENSOR)		
					Q3003	PTZ-NV16A	IC(PHOTO SENSOR)		
					Q3004	2SD1819A/QRS/-X	TRANSISTOR		
					Q3004	or 2SC4081/QRS/-X	TRANSISTOR		
					Q3004	or 2PC4081/R/-X	TRANSISTOR		
					Q3005	2SD1819A/QRS/-X	TRANSISTOR		
					Q3005	or 2SC4081/QRS/-X	TRANSISTOR		
					Q3005	or 2PC4081/R/-X	TRANSISTOR		
					Q3011	DTC143EUA-X	DIGI TRANSISTOR		
					Q3011	or UN521L-X	DIGI TRANSISTOR		

\*The VCR goes to jig RCU mode after replacing the EEPROM and the VCR does not accept some RCU command.  
Therefore please set the VCR to the user RCU mode after replacing the EEPROM.  
The method of setting the VCR to the user RCU mode is written on the service manual.

MODEL	MARK
DR-MV1SUC	A
DR-MV1SUS	B

△ Symbol No.	Part No.	Part Name	Description	Local	△ Symbol No.	Part No.	Part Name	Description	Local
Q3011	or PDTC143EU-X	DIGI TRANSISTOR			C44	QEKJ1HM-225Z	E CAPACITOR	2.2uF 50V M	
Q3011	or RN1301-X	TRANSISTOR			C45	NCB31EK-472X	C CAPACITOR	4700pF 25V K	
Q4001	UN5211-X	DIGI TRANSISTOR			C46	NCB31CK-104X	C CAPACITOR	0.1uF 16V K	
Q4001	or DTC114EUA-X	DIGI TRANSISTOR			C47	QEKJ1HM-474Z	E CAPACITOR	0.47uF 50V M	
Q4001	or RN1302-X	DIGI TRANSISTOR			C48	NCB31EK-223X	C CAPACITOR	0.022uF 25V K	
Q6030	2SB1218A/QR/-X	TRANSISTOR			C49	QEKJ1HM-475Z	E CAPACITOR	4.7uF 50V M	
Q6030	or 2SA1576A/QR/-X	TRANSISTOR			C56	NCB31CK-104X	C CAPACITOR	0.1uF 16V K	
Q6030	or 2PA1576R/-X	TRANSISTOR			C57	NCF31EZ-104X	C CAPACITOR	0.1uF 25V Z	
Q6130	2SB1218A/QR/-X	TRANSISTOR			C58	NCF31EZ-104X	C CAPACITOR	0.1uF 25V Z	
Q6130	or 2SA1576A/QR/-X	TRANSISTOR			C59	NCF31EZ-104X	C CAPACITOR	0.1uF 25V Z	
Q6130	or 2PA1576R/-X	TRANSISTOR			C60	NCF31EZ-104X	C CAPACITOR	0.1uF 25V Z	
Q7201	2SC1317/RS-T	TRANSISTOR			C61	QEK0JM-476Z	E CAPACITOR	47uF 6.3V M	
Q7501	2SB1218A/QR/-X	TRANSISTOR			C62	QCB1HK-103Y	C CAPACITOR	0.01uF 50V K	
Q7501	or 2SA1576A/QR/-X	TRANSISTOR			C501	QEKJ0JM-476Z	E CAPACITOR	47uF 6.3V M	
Q7501	or 2PA1576R/-X	TRANSISTOR			C502	NCB31CK-104X	C CAPACITOR	0.1uF 16V K	
Q7573	2SB1218A/QR/-X	TRANSISTOR			C503	NCF31AZ-105X	C CAPACITOR	1uF 10V Z	
Q7573	or 2SA1576A/QR/-X	TRANSISTOR			C505	NCB31EK-103X	C CAPACITOR	0.01uF 25V K	
Q7573	or 2PA1576R/-X	TRANSISTOR			C506	NCB31EK-103X	C CAPACITOR	0.01uF 25V K	
D501	DA204U-X	SI DIODE			C508	NCF31AZ-105X	C CAPACITOR	1uF 10V Z	
D502	DA204U-X	SI DIODE			C510	NCB31EK-103X	C CAPACITOR	0.01uF 25V K	
D2001	1SS133-T2	DIODE			C512	NCB31EK-103X	C CAPACITOR	0.01uF 25V K	
D2001	or 1SS270A-T2	SI DIODE			C513	NCF31AZ-105X	C CAPACITOR	1uF 10V Z	
D2251	1SS133-T2	DIODE			C515	NCB31EK-103X	C CAPACITOR	0.01uF 25V K	
D2251	or 1SS270A-T2	SI DIODE			C516	NCB31EK-103X	C CAPACITOR	0.01uF 25V K	
D2601	1SS133-T2	DIODE			C518	NCF31AZ-105X	C CAPACITOR	1uF 10V Z	
D2601	or 1SS270A-T2	SI DIODE			C519	NCF31AZ-105X	C CAPACITOR	1uF 10V Z	
D3001	LNB2301L01V1	LED			C521	NCB31EK-103X	C CAPACITOR	0.01uF 25V K	
D3002	1SS133-T2	DIODE			C522	NCB31EK-103X	C CAPACITOR	0.01uF 25V K	
D3002	or 1SS270A-T2	SI DIODE			C523	NCB31EK-103X	C CAPACITOR	0.01uF 25V K	
D3003	RD39ES/B3/-T2	Z DIODE			C524	NCB31EK-103X	C CAPACITOR	0.01uF 25V K	
D3003	or MTZJ39C-T2	Z DIODE			C525	NCB31EK-103X	C CAPACITOR	0.01uF 25V K	
D3004	1A3G-T2	SI DIODE			C526	NCB31EK-103X	C CAPACITOR	0.01uF 25V K	
D3005	1A3G-T2	SI DIODE			C527	NCF31AZ-105X	C CAPACITOR	1uF 10V Z	
D4002	NRSA63J-0R0X	MG RESISTOR	0Ω 1/16W J		C528	QEKJ1CM-106Z	E CAPACITOR	10uF 16V M	
D6002	HZ30-2L-T2	Z DIODE			C529	QEKJ0JM-476Z	E CAPACITOR	47uF 6.3V M	
D6002	or HZ30-2LTD	Z DIODE			C530	NCB31EK-103X	C CAPACITOR	0.01uF 25V K	
PC3001	RPI-304J	IC(PHOTO SENSOR)			C533	NCB31EK-103X	C CAPACITOR	0.01uF 25V K	
PC3002	RPI-304J	IC(PHOTO SENSOR)			C534	QEKJ1HM-475Z	E CAPACITOR	4.7uF 50V M	
C1	NDC31HJ-151X	C CAPACITOR	150pF 50V J		C535	NCB31EK-103X	C CAPACITOR	0.01uF 25V K	
C2	NDC31HJ-330X	C CAPACITOR	33pF 50V J		C536	NCB31EK-103X	C CAPACITOR	0.01uF 25V K	
C4	QEKJ1EM-106Z	E CAPACITOR	10uF 25V M		C537	NCB31EK-103X	C CAPACITOR	0.01uF 25V K	
C5	NCB31CK-104X	C CAPACITOR	0.1uF 16V K		C538	NCB31EK-104X	C CAPACITOR	0.1uF 25V K	
C6	NCB31CK-104X	C CAPACITOR	0.1uF 16V K		C539	NCB31EK-103X	C CAPACITOR	0.01uF 25V K	
C7	NCB31CK-104X	C CAPACITOR	0.1uF 16V K		C540	NCB31EK-103X	C CAPACITOR	0.01uF 25V K	
C8	NCF31AZ-105X	C CAPACITOR	1uF 10V Z		C541	NCB31EK-103X	C CAPACITOR	0.01uF 25V K	
C9	QEKJ1HM-225Z	E CAPACITOR	2.2uF 50V M		C543	NCB31EK-104X	C CAPACITOR	0.1uF 25V K	
C10	QEKJ0JM-476Z	E CAPACITOR	47uF 6.3V M		C545	QEKJ1HM-225Z	E CAPACITOR	2.2uF 50V M	
C11	NCF31AZ-105X	C CAPACITOR	1uF 10V Z		C546	NCB31EK-103X	C CAPACITOR	0.01uF 25V K	
C12	NCF31AZ-105X	C CAPACITOR	1uF 10V Z		C547	NCB31EK-103X	C CAPACITOR	0.01uF 25V K	
C13	NCF31AZ-105X	C CAPACITOR	1uF 10V Z		C549	NDC31HJ-120X	C CAPACITOR	12pF 50V J	
C14	NCF31AZ-105X	C CAPACITOR	1uF 10V Z		C550	NDC31HJ-820X	C CAPACITOR	82pF 50V J	
C15	NCB31CK-104X	C CAPACITOR	0.1uF 16V K		C555	NCB31EK-104X	C CAPACITOR	0.1uF 25V K	
C17	NCB31CK-104X	C CAPACITOR	0.1uF 16V K		C556	NCB31EK-103X	C CAPACITOR	0.01uF 25V K	
C19	NCB31CK-104X	C CAPACITOR	0.1uF 16V K		C565	QEKJ0JM-476Z	E CAPACITOR	47uF 6.3V M	
C20	NCB31CK-104X	C CAPACITOR	0.1uF 16V K		C577	NCB31EK-103X	C CAPACITOR	0.01uF 25V K	
C22	NCB31CK-104X	C CAPACITOR	0.1uF 16V K		C578	NCB31EK-104X	C CAPACITOR	0.1uF 25V K	
C24	NCB31CK-104X	C CAPACITOR	0.1uF 16V K		C2001	QEKJ1HM-475Z	E CAPACITOR	4.7uF 50V M	
C25	QEKJ1HM-335Z	E CAPACITOR	3.3uF 50V M		C2002	QEKJ1HM-105Z	E CAPACITOR	1uF 50V M	
C26	QEKJ1EM-106Z	E CAPACITOR	10uF 25V M		C2003	QEKJ0JM-476Z	E CAPACITOR	47uF 6.3V M	
C27	NCB31EK-103X	C CAPACITOR	0.01uF 25V K		C2004	NCB31EK-103X	C CAPACITOR	0.01uF 25V K	
C28	NDC31HJ-470X	C CAPACITOR	47pF 50V J		C2005	QEKJ1HM-475Z	E CAPACITOR	4.7uF 50V M	
C29	NCB31EK-103X	C CAPACITOR	0.01uF 25V K		C2006	NCB31EK-682X	C CAPACITOR	6800pF 25V K	
C30	QCB1HK-331Y	C CAPACITOR	330pF 50V K		C2007	QEKJ1CM-226Z	E CAPACITOR	22uF 16V M	
C31	QEKJ0JM-476Z	E CAPACITOR	47uF 6.3V M		C2008	QEKJ1HM-475Z	E CAPACITOR	4.7uF 50V M	
C32	NCB31CK-104X	C CAPACITOR	0.1uF 16V K		C2009	NCB31HK-821X	C CAPACITOR	820pF 50V K	
C33	QEKJ1EM-106Z	E CAPACITOR	10uF 25V M		C2010	NCB31HK-821X	C CAPACITOR	820pF 50V K	
C34	NCB31EK-103X	C CAPACITOR	0.01uF 25V K		C2011	QEKJ1HM-475Z	E CAPACITOR	4.7uF 50V M	
C35	QCB1HK-103Y	C CAPACITOR	0.01uF 50V K		C2012	QEKJ1HM-475Z	E CAPACITOR	4.7uF 50V M	
C36	QEKJ1HM-105Z	E CAPACITOR	1uF 50V M		C2051	NDC31HJ-331X	C CAPACITOR	330pF 50V J	
C37	NDC31HJ-4R0X	C CAPACITOR	4pF 50V J		C2052	QFV61HJ-823Z	MF CAPACITOR	0.082uF 50V J	
C38	NCB31EK-103X	C CAPACITOR	0.01uF 25V K		C2053	NCB31HK-472X	C CAPACITOR	4700pF 50V K	
C39	QEKJ0JM-476Z	E CAPACITOR	47uF 6.3V M		C2054	NCB31EK-223X	C CAPACITOR	0.022uF 25V K	
C40	NCB31EK-103X	C CAPACITOR	0.01uF 25V K		C2055	QEKJ1EM-106Z	E CAPACITOR	10uF 25V M	
C41	NCB31CK-104X	C CAPACITOR	0.1uF 16V K		C2201	QEKJ1EM-106Z	E CAPACITOR	10uF 25V M	
C43	QEKJ1HM-335Z	E CAPACITOR	3.3uF 50V M		C2202	QEKJ1HM-475Z	E CAPACITOR	4.7uF 50V M	
					C2203	QEKJ1HM-475Z	E CAPACITOR	4.7uF 50V M	
					C2204	QEKJ0JM-336Z	E CAPACITOR	33uF 6.3V M	
					C2205	QEKJ1EM-106Z	E CAPACITOR	10uF 25V M	

MODEL	MARK
DR-MV1SUC	A
DR-MV1SUS	B

△ Symbol No.	Part No.	Part Name	Description	Local	△ Symbol No.	Part No.	Part Name	Description	Local
C2206	QEKJ1EM-106Z	E CAPACITOR	10uF 25V M		C7502	NCB31EK-103X	C CAPACITOR	0.01uF 25V K	
C2207	NCB31EK-153X	C CAPACITOR	0.015uF 25V K		C7517	NCB31EK-103X	C CAPACITOR	0.01uF 25V K	
C2208	NCB31EK-153X	C CAPACITOR	0.015uF 25V K		C7518	QETN0JM-477Z	E CAPACITOR	470uF 6.3V M	
C2209	QEKJ1EM-106Z	E CAPACITOR	10uF 25V M		C7519	QETN0JM-477Z	E CAPACITOR	470uF 6.3V M	
C2210	QEKJ1EM-106Z	E CAPACITOR	10uF 25V M		C7520	QETN0JM-477Z	E CAPACITOR	470uF 6.3V M	
C2211	QEKJ0JM-336Z	E CAPACITOR	33uF 6.3V M		C7521	QETN0JM-477Z	E CAPACITOR	470uF 6.3V M	
C2212	QEKJ0JM-476Z	E CAPACITOR	47uF 6.3V M		C7529	NCB31EK-103X	C CAPACITOR	0.01uF 25V K	
C2214	QEKJ1EM-106Z	E CAPACITOR	10uF 25V M		C7538	QETJ0JM-477Z	E CAPACITOR	470uF 6.3V M	
C2215	QEKJ1EM-106Z	E CAPACITOR	10uF 25V M		C7539	QETN0JM-477Z	E CAPACITOR	470uF 6.3V M	
C2216	QEKJ1CM-476Z	E CAPACITOR	47uF 16V M		C7553	NCB31HK-103X	C CAPACITOR	0.01uF 50V K	
C2219	QEKJ1CM-226Z	E CAPACITOR	22uF 16V M		C7575	NCB31HK-103X	C CAPACITOR	0.01uF 50V K	
C2220	QEKJ1EM-106Z	E CAPACITOR	10uF 25V M		C7576	QEKJ1CM-107Z	E CAPACITOR	100uF 16V M	
C2221	NCB31EK-223X	C CAPACITOR	0.022uF 25V K		C7581	NCB31HK-221X	C CAPACITOR	220pF 50V K	
C2222	NCB31EK-103X	C CAPACITOR	0.01uF 25V K		C7582	NCB31HK-221X	C CAPACITOR	220pF 50V K	
C2234	NCB30JK-105X	C CAPACITOR	1uF 6.3V K		C7585	NCB31HK-221X	C CAPACITOR	220pF 50V K	
C2235	NCB30JK-105X	C CAPACITOR	1uF 6.3V K		C7586	NCB31HK-221X	C CAPACITOR	220pF 50V K	
C2251	NCB31EK-103X	C CAPACITOR	0.01uF 25V K		C7587	NCB31HK-221X	C CAPACITOR	220pF 50V K	
C2252	NCB31EK-103X	C CAPACITOR	0.01uF 25V K		C7588	NCB31HK-221X	C CAPACITOR	220pF 50V K	
C2253	NCB31EK-103X	C CAPACITOR	0.01uF 25V K		R1	NRSA63J-622X	MG RESISTOR	6.2kΩ 1/16W J	
C2254	QEKJ0JM-476Z	E CAPACITOR	47uF 6.3V M		R2	NRSA63J-152X	MG RESISTOR	1.5kΩ 1/16W J	
C2255	NCB31EK-103X	C CAPACITOR	0.01uF 25V K		R3	NRSA63J-822X	MG RESISTOR	8.2kΩ 1/16W J	
C2256	NCB31EK-103X	C CAPACITOR	0.01uF 25V K		R11	NRSA63J-472X	MG RESISTOR	4.7kΩ 1/16W J	
C2257	QCBB1HK-103Y	C CAPACITOR	0.01uF 50V K		R12	NRSA63J-102X	MG RESISTOR	1kΩ 1/16W J	
C2259	QEKJ1HM-334Z	E CAPACITOR	0.33uF 50V M		R19	NCB31EK-103X	C CAPACITOR	0.01uF 25V K	
C2603	QEKJ1EM-106Z	E CAPACITOR	10uF 25V M		R36	NRSA63J-272X	MG RESISTOR	2.7kΩ 1/16W J	
C2604	QEKJ1EM-106Z	E CAPACITOR	10uF 25V M		R37	NRSA63J-153X	MG RESISTOR	15kΩ 1/16W J	
C2651	QEKJ1CM-476Z	E CAPACITOR	47uF 16V M		R38	NRSA63J-475X	MG RESISTOR	4.7kΩ 1/16W J	
C2653	QEKJ1CM-476Z	E CAPACITOR	47uF 16V M		R501	NRSA63J-0R0X	MG RESISTOR	0Ω 1/16W J	
C3004	NCB31EK-473X	C CAPACITOR	0.047uF 25V K		R502	NRSA63J-103X	MG RESISTOR	10kΩ 1/16W J	
C3012	QEKJ0JM-476Z	E CAPACITOR	47uF 6.3V M		R503	NRSA63J-0R0X	MG RESISTOR	0Ω 1/16W J	
C3015	NCB31CK-104X	C CAPACITOR	0.1uF 16V K		R504	NRSA63J-0R0X	MG RESISTOR	0Ω 1/16W J	
C3016	NCB31CK-104X	C CAPACITOR	0.1uF 16V K		R507	NRSA63J-0R0X	MG RESISTOR	0Ω 1/16W J	
C3022	NCB31CK-104X	C CAPACITOR	0.1uF 16V K		R508	NRSA63J-103X	MG RESISTOR	10kΩ 1/16W J	
C3024	NDC31HJ-220X	C CAPACITOR	22pF 50V J		R509	NRSA63J-0R0X	MG RESISTOR	0Ω 1/16W J	
C3025	QAT3725-300Z	TRIM CAPACITOR	30pF TIMER CLOCK		R510	NRSA63J-332X	MG RESISTOR	3.3kΩ 1/16W J	
C3027	QERF1CM-106Z	E CAPACITOR	10uF 16V M		R511	NRSA63J-0R0X	MG RESISTOR	0Ω 1/16W J	
C3030	QERF1CM-476Z	E CAPACITOR	47uF 16V M		R512	NRSA63J-0R0X	MG RESISTOR	0Ω 1/16W J	
C3031	NCB31CK-104X	C CAPACITOR	0.1uF 16V K		R518	NRSA63J-272X	MG RESISTOR	2.7kΩ 1/16W J	
C3032	NCB31CK-104X	C CAPACITOR	0.1uF 16V K		R521	NRSA63J-271X	MG RESISTOR	270Ω 1/16W J	
C3033	NCB31CK-104X	C CAPACITOR	0.1uF 16V K		R526	NRSA63J-102X	MG RESISTOR	1kΩ 1/16W J	
C3036	NDC31HJ-180X	C CAPACITOR	18pF 50V J		R527	NRSA63J-562X	MG RESISTOR	5.6kΩ 1/16W J	
C3037	NDC31HJ-120X	C CAPACITOR	12pF 50V J		R528	NRSA63J-562X	MG RESISTOR	5.6kΩ 1/16W J	
C3042	QETJ0JM-477Z	E CAPACITOR	470uF 6.3V M		R529	NRSA63J-222X	MG RESISTOR	2.2kΩ 1/16W J	
C3050	NCB31CK-104X	C CAPACITOR	0.1uF 16V K		R533	NRSA63J-472X	MG RESISTOR	4.7kΩ 1/16W J	
C3054	NCB31CK-104X	C CAPACITOR	0.1uF 16V K		R534	NRSA63J-222X	MG RESISTOR	2.2kΩ 1/16W J	
C3071	QEKJ1HM-336Z	E CAPACITOR	33uF 50V M		R535	NRSA63J-152X	MG RESISTOR	1.5kΩ 1/16W J	
C3602	NCB31EK-104X	C CAPACITOR	0.1uF 25V K		R542	NRSA63J-102X	MG RESISTOR	1kΩ 1/16W J	
C4002	NCB31HK-103X	C CAPACITOR	0.01uF 50V K		R545	NRSA63J-471X	MG RESISTOR	470Ω 1/16W J	
C4004	NBE20JM-226X	TA E CAPACITOR	22uF 6.3V M		R546	NRSA63J-471X	MG RESISTOR	470Ω 1/16W J	
C4005	NCB31HK-222X	C CAPACITOR	2200pF 50V K		R547	NRSA63J-0R0X	MG RESISTOR	0Ω 1/16W J	
C4006	NBE40JM-476X	TA E CAPACITOR	47uF 6.3V M		R551	NRSA63J-0R0X	MG RESISTOR	0Ω 1/16W J	
C4008	NCB30JK-105X	C CAPACITOR	1uF 6.3V K		R2007	NRSA63J-123X	MG RESISTOR	12kΩ 1/16W J	
C4009	NRSA63J-0R0X	MG RESISTOR	0Ω 1/16W J		R2010	NRSA63J-123X	MG RESISTOR	12kΩ 1/16W J	
C4010	NCB31EK-223X	C CAPACITOR	0.022uF 25V K		R2013	NRSA63J-123X	MG RESISTOR	12kΩ 1/16W J	
C4011	NCB31CK-104X	C CAPACITOR	0.1uF 16V K		R2014	NRSA63J-394X	MG RESISTOR	390kΩ 1/16W J	
C4012	NCB30JK-105X	C CAPACITOR	1uF 6.3V K		R2015	NRSA63J-331X	MG RESISTOR	330Ω 1/16W J	
C4014	NDC31HJ-101X	C CAPACITOR	100pF 50V J		R2016	NRSA63J-333X	MG RESISTOR	33kΩ 1/16W J	
C4015	NCB31HK-102X	C CAPACITOR	1000pF 50V K		R2017	NRSA63J-223X	MG RESISTOR	22kΩ 1/16W J	
C4018	NCB31HK-102X	C CAPACITOR	1000pF 50V K		R2018	NRSA63J-472X	MG RESISTOR	4.7kΩ 1/16W J	
C4031	QEKJ1CM-336Z	E CAPACITOR	33uF 16V M		R2019	NRSA63J-472X	MG RESISTOR	4.7kΩ 1/16W J	
C6013	NCB31HK-103X	C CAPACITOR	0.01uF 50V K		R2021	NRSA63J-333X	MG RESISTOR	33kΩ 1/16W J	
C6021	NDC31HJ-331X	C CAPACITOR	330pF 50V J		R2022	NRSA63J-103X	MG RESISTOR	10kΩ 1/16W J	
C6501	NCB31CK-104X	C CAPACITOR	0.1uF 16V K		R2023	NRSA63J-103X	MG RESISTOR	10kΩ 1/16W J	
C6502	QEKJ1EM-106Z	E CAPACITOR	10uF 25V M		R2024	NRSA63J-103X	MG RESISTOR	10kΩ 1/16W J	
C6503	QEKJ1HM-105Z	E CAPACITOR	1uF 50V M		R2053	NRSA63J-682X	MG RESISTOR	6.8kΩ 1/16W J	
C6504	NCB31CK-104X	C CAPACITOR	0.1uF 16V K		R2054	NRSA63J-123X	MG RESISTOR	12kΩ 1/16W J	
C6505	QEKJ1HM-335Z	E CAPACITOR	3.3uF 50V M		R2055	NRSA63J-3R3X	MG RESISTOR	3.3Ω 1/16W J	
C6508	NCB31CK-223X	C CAPACITOR	0.022uF 16V K		R2056	QRE141J-820Y	C RESISTOR	82Ω 1/4W J	
C6509	NCB31CK-104X	C CAPACITOR	0.1uF 16V K		R2057	NRSA63J-473X	MG RESISTOR	47kΩ 1/16W J	
C6512	NCB31EK-223X	C CAPACITOR	0.022uF 25V K		R2058	NRSA63J-183X	MG RESISTOR	18kΩ 1/16W J	
C6513	QEKJ1HM-225Z	E CAPACITOR	2.2uF 50V M		R2059	NRSA63J-473X	MG RESISTOR	47kΩ 1/16W J	
C6514	NCB31EK-223X	C CAPACITOR	0.022uF 25V K		R2060	NRSA63J-183X	MG RESISTOR	18kΩ 1/16W J	
C6515	QEKJ1HM-335Z	E CAPACITOR	3.3uF 50V M		R2201	NRSA63J-473X	MG RESISTOR	47kΩ 1/16W J	
C6516	QEKJ1HM-475Z	E CAPACITOR	4.7uF 50V M		R2202	NRSA63J-682X	MG RESISTOR	6.8kΩ 1/16W J	
C6517	NCB31AK-224X	C CAPACITOR	0.22uF 10V K		R2203	NRSA63J-473X	MG RESISTOR	47kΩ 1/16W J	
C6532	QCBB1HK-104Y	C CAPACITOR	0.1uF 50V K		R2204	NRSA63J-682X	MG RESISTOR	6.8kΩ 1/16W J	
C7201	QEKJ0JM-227Z	E CAPACITOR	220uF 6.3V M		R2205	NRSA63J-473X	MG RESISTOR	47kΩ 1/16W J	
C7501	QEKJ0JM-476Z	E CAPACITOR	47uF 6.3V M						

MODEL	MARK
DR-MV1SUC	A
DR-MV1SUS	B

△ Symbol No.	Part No.	Part Name	Description	Local	△ Symbol No.	Part No.	Part Name	Description	Local
R2206	NRSA63J-682X	MG RESISTOR	6.8kΩ 1/16W J		R3052	NRSA63J-471X	MG RESISTOR	470Ω 1/16W J	
R2207	NRSA63J-473X	MG RESISTOR	47kΩ 1/16W J		R3053	NRSA63J-471X	MG RESISTOR	470Ω 1/16W J	
R2208	NRSA63J-682X	MG RESISTOR	6.8kΩ 1/16W J		R3054	NRSA63J-102X	MG RESISTOR	1kΩ 1/16W J	
R2209	NRSA63J-101X	MG RESISTOR	100Ω 1/16W J		R3055	NRSA63J-102X	MG RESISTOR	1kΩ 1/16W J	
R2210	NRSA63J-472X	MG RESISTOR	4.7kΩ 1/16W J		R3056	NRSA63J-0R0X	MG RESISTOR	0Ω 1/16W J	
R2211	NRSA63J-332X	MG RESISTOR	3.3kΩ 1/16W J		R3057	NRSA63J-101X	MG RESISTOR	100Ω 1/16W J	
R2212	NRSA63J-332X	MG RESISTOR	3.3kΩ 1/16W J		R3058	NRSA63J-0R0X	MG RESISTOR	0Ω 1/16W J	
R2213	NRSA63J-472X	MG RESISTOR	4.7kΩ 1/16W J		R3059	NRSA63J-102X	MG RESISTOR	1kΩ 1/16W J	
R2214	NRSA63J-101X	MG RESISTOR	100Ω 1/16W J		R3060	NRSA63J-471X	MG RESISTOR	470Ω 1/16W J	
R2215	NRSA63J-0R0X	MG RESISTOR	0Ω 1/16W J		R3061	NRSA63J-471X	MG RESISTOR	470Ω 1/16W J	
R2218	NRSA63J-392X	MG RESISTOR	3.9kΩ 1/16W J		R3062	NRSA63J-103X	MG RESISTOR	10kΩ 1/16W J	
R2219	NRSA63J-102X	MG RESISTOR	1kΩ 1/16W J		R3063	NRSA63J-472X	MG RESISTOR	4.7kΩ 1/16W J	
R2220	NRSA63J-102X	MG RESISTOR	1kΩ 1/16W J		R3066	NRSA63J-472X	MG RESISTOR	4.7kΩ 1/16W J	
R2226	NRSA63J-393X	MG RESISTOR	39kΩ 1/16W J		R3069	NRSA63J-101X	MG RESISTOR	100Ω 1/16W J	
R2227	NRSA63J-682X	MG RESISTOR	6.8kΩ 1/16W J		R3071	NRSA63J-103X	MG RESISTOR	10kΩ 1/16W J	
R2228	NRSA63J-393X	MG RESISTOR	39kΩ 1/16W J		R3072	NRSA63J-0R0X	MG RESISTOR	0Ω 1/16W J	
R2229	NRSA63J-682X	MG RESISTOR	6.8kΩ 1/16W J		R3074	NRSA63J-0R0X	MG RESISTOR	0Ω 1/16W J	
R2230	QRE141J-471Y	C RESISTOR	470Ω 1/4W J		R3075	NRSA63J-471X	MG RESISTOR	470Ω 1/16W J	
R2231	QRE141J-471Y	C RESISTOR	470Ω 1/4W J		R3076	NRSA63J-471X	MG RESISTOR	470Ω 1/16W J	
R2251	NRSA63J-472X	MG RESISTOR	4.7kΩ 1/16W J		R3078	NRSA63J-102X	MG RESISTOR	1kΩ 1/16W J	
R2252	NRSA63J-332X	MG RESISTOR	3.3kΩ 1/16W J		R3079	QRE141J-471Y	C RESISTOR	470Ω 1/4W J	
R2253	NRSA63J-101X	MG RESISTOR	100Ω 1/16W J		R3080	NRSA63J-102X	MG RESISTOR	1kΩ 1/16W J	
R2257	NRSA63J-684X	MG RESISTOR	680kΩ 1/16W J		R3083	NRSA63J-102X	MG RESISTOR	1kΩ 1/16W J	
R2259	NRSA63J-273X	MG RESISTOR	27kΩ 1/16W J		R3085	NRSA63J-222X	MG RESISTOR	2.2kΩ 1/16W J	
R2609	NRSA63J-102X	MG RESISTOR	1kΩ 1/16W J		R3088	NRSA63J-0R0X	MG RESISTOR	0Ω 1/16W J	
R2610	NRSA63J-101X	MG RESISTOR	100Ω 1/16W J		R3089	NRSA63J-0R0X	MG RESISTOR	0Ω 1/16W J	
R2611	NRSA63J-101X	MG RESISTOR	100Ω 1/16W J		R3090	NRSA63J-0R0X	MG RESISTOR	0Ω 1/16W J	
R2631	NRSA63J-102X	MG RESISTOR	1kΩ 1/16W J		R3091	QRE141J-102Y	C RESISTOR	1kΩ 1/4W J	
R2632	QRE141J-471Y	C RESISTOR	470Ω 1/4W J		R3092	NRSA63J-102X	MG RESISTOR	1kΩ 1/16W J	
R2633	NRSA63J-471X	MG RESISTOR	470Ω 1/16W J		R3094	NRSA63J-102X	MG RESISTOR	1kΩ 1/16W J	
R2634	NRSA63J-103X	MG RESISTOR	10kΩ 1/16W J		R3095	QRE141J-102Y	C RESISTOR	1kΩ 1/4W J	
R2635	NRSA63J-103X	MG RESISTOR	10kΩ 1/16W J		R3097	NRSA63J-0R0X	MG RESISTOR	0Ω 1/16W J	
R2636	NRSA63J-472X	MG RESISTOR	4.7kΩ 1/16W J		R3104	NRSA63J-102X	MG RESISTOR	1kΩ 1/16W J	
R2637	NRSA63J-472X	MG RESISTOR	4.7kΩ 1/16W J		R3106	NRSA63J-102X	MG RESISTOR	1kΩ 1/16W J	
R2638	NRSA63J-102X	MG RESISTOR	1kΩ 1/16W J		R3205	QRE141J-181Y	C RESISTOR	180Ω 1/4W J	
R2651	QRE141J-221Y	C RESISTOR	220Ω 1/4W J		R3206	NRSA63J-123X	MG RESISTOR	12kΩ 1/16W J	
R2652	NRSA63J-0R0X	MG RESISTOR	0Ω 1/16W J		R3207	NRSA63J-183X	MG RESISTOR	18kΩ 1/16W J	
R2653	NRSA63J-103X	MG RESISTOR	10kΩ 1/16W J		R3208	NRSA63J-121X	MG RESISTOR	120Ω 1/16W J	
R2654	NRSA63J-153X	MG RESISTOR	15kΩ 1/16W J		R3209	NRSA63J-183X	MG RESISTOR	18kΩ 1/16W J	
R2658	NRSA63J-103X	MG RESISTOR	10kΩ 1/16W J		R3210	NRSA63J-121X	MG RESISTOR	120Ω 1/16W J	
R2659	NRSA63J-103X	MG RESISTOR	10kΩ 1/16W J		R3211	NRSA63J-183X	MG RESISTOR	18kΩ 1/16W J	
R2660	NRSA63J-103X	MG RESISTOR	10kΩ 1/16W J		R3212	QRE141J-474Y	C RESISTOR	470kΩ 1/4W J	
R2661	NRSA63J-103X	MG RESISTOR	10kΩ 1/16W J		R3213	NRSA63J-334X	MG RESISTOR	330kΩ 1/16W J	
R2662	NRSA63J-223X	MG RESISTOR	22kΩ 1/16W J		R3214	NRSA63J-103X	MG RESISTOR	10kΩ 1/16W J	
R2663	NRSA63J-223X	MG RESISTOR	22kΩ 1/16W J		R3215	NRSA63J-103X	MG RESISTOR	10kΩ 1/16W J	
R2666	NRSA63J-223X	MG RESISTOR	22kΩ 1/16W J		R3216	NRSA63J-103X	MG RESISTOR	10kΩ 1/16W J	
R2667	NRSA63J-223X	MG RESISTOR	22kΩ 1/16W J		R3217	NRSA63J-103X	MG RESISTOR	10kΩ 1/16W J	
R3011	NRSA63J-0R0X	MG RESISTOR	0Ω 1/16W J		R3218	NRSA63J-472X	MG RESISTOR	4.7kΩ 1/16W J	
R3012	NRSA63J-0R0X	MG RESISTOR	0Ω 1/16W J		R3219	NRSA63J-472X	MG RESISTOR	4.7kΩ 1/16W J	
R3013	NRSA63J-472X	MG RESISTOR	4.7kΩ 1/16W J		R3220	NRSA63J-104X	MG RESISTOR	100kΩ 1/16W J	
R3014	NRSA63J-0R0X	MG RESISTOR	0Ω 1/16W J		R3222	NRSA63J-103X	MG RESISTOR	10kΩ 1/16W J	
R3015	NRSA63J-0R0X	MG RESISTOR	0Ω 1/16W J		R3223	NRSA63J-472X	MG RESISTOR	4.7kΩ 1/16W J	
R3016	NRSA63J-472X	MG RESISTOR	4.7kΩ 1/16W J		R3224	NRSA63J-472X	MG RESISTOR	4.7kΩ 1/16W J	
R3017	NRSA63J-472X	MG RESISTOR	4.7kΩ 1/16W J		R3229	NRSA63J-105X	MG RESISTOR	1MΩ 1/16W J	
R3018	NRSA63J-0R0X	MG RESISTOR	0Ω 1/16W J		R3230	NRSA63J-472X	MG RESISTOR	4.7kΩ 1/16W J	
R3021	NRSA63J-0R0X	MG RESISTOR	0Ω 1/16W J		R3231	NRSA63J-102X	MG RESISTOR	1kΩ 1/16W J	
R3022	NRSA63J-0R0X	MG RESISTOR	0Ω 1/16W J		R3235	NRSA63J-332X	MG RESISTOR	3.3kΩ 1/16W J	
R3025	NRSA63J-0R0X	MG RESISTOR	0Ω 1/16W J		R3236	NRSA63J-332X	MG RESISTOR	3.3kΩ 1/16W J	
R3026	NRSA63J-0R0X	MG RESISTOR	0Ω 1/16W J		R3237	NRSA63J-103X	MG RESISTOR	10kΩ 1/16W J	
R3027	NRSA63J-102X	MG RESISTOR	1kΩ 1/16W J		R3241	NRSA63J-104X	MG RESISTOR	100kΩ 1/16W J	
R3029	NRSA63J-472X	MG RESISTOR	4.7kΩ 1/16W J		R3253	NRSA63J-103X	MG RESISTOR	10kΩ 1/16W J	
R3032	NRSA63J-101X	MG RESISTOR	100Ω 1/16W J		R3257	NRSA63J-103X	MG RESISTOR	10kΩ 1/16W J	
R3033	NRSA63J-0R0X	MG RESISTOR	0Ω 1/16W J		R3258	NRSA63J-103X	MG RESISTOR	10kΩ 1/16W J	
R3035	NRSA63J-0R0X	MG RESISTOR	0Ω 1/16W J		R3259	NRSA63J-0R0X	MG RESISTOR	0Ω 1/16W J	
R3036	NRSA63J-472X	MG RESISTOR	4.7kΩ 1/16W J		R3260	NRSA63J-473X	MG RESISTOR	47kΩ 1/16W J	
R3037	NRSA63J-0R0X	MG RESISTOR	0Ω 1/16W J		R3261	NRSA63J-103X	MG RESISTOR	10kΩ 1/16W J	
R3038	NRSA63J-182X	MG RESISTOR	1.8kΩ 1/16W J		R3262	NRSA63J-103X	MG RESISTOR	10kΩ 1/16W J	
R3039	NRSA63J-0R0X	MG RESISTOR	0Ω 1/16W J		R3263	NRSA63J-103X	MG RESISTOR	10kΩ 1/16W J	
R3040	NRSA63J-0R0X	MG RESISTOR	0Ω 1/16W J		R3264	NRSA63J-103X	MG RESISTOR	10kΩ 1/16W J	
R3041	NRSA63J-0R0X	MG RESISTOR	0Ω 1/16W J		R3265	NRSA63J-332X	MG RESISTOR	3.3kΩ 1/16W J	
R3042	NRSA63J-0R0X	MG RESISTOR	0Ω 1/16W J		R3601	NRSA63J-222X	MG RESISTOR	2.2kΩ 1/16W J	
R3044	NRSA63J-0R0X	MG RESISTOR	0Ω 1/16W J		R3608	NRSA63J-222X	MG RESISTOR	2.2kΩ 1/16W J	
R3046	NRSA63J-0R0X	MG RESISTOR	0Ω 1/16W J		R3612	NRSA63J-103X	MG RESISTOR	10kΩ 1/16W J	
R3047	NRSA63J-0R0X	MG RESISTOR	0Ω 1/16W J		R4003	NRSA63J-561X	MG RESISTOR	560Ω 1/16W J	
R3048	NRSA63J-0R0X	MG RESISTOR	0Ω 1/16W J		R4004	NRSA63J-561X	MG RESISTOR	560Ω 1/16W J	
R3049	NRSA63J-0R0X	MG RESISTOR	0Ω 1/16W J		R4005	NRSA63J-562X	MG RESISTOR	5.6kΩ 1/16W J	
R3050	NRSA63J-0R0X	MG RESISTOR	0Ω 1/16W J		R4007	NRSA63J-102X	MG RESISTOR	1kΩ 1/16W J	
R3051	NRSA63J-471X	MG RESISTOR	470Ω 1/16W J		R4008	NRSA63J-102X	MG RESISTOR	1kΩ 1/16W J	

MODEL	MARK
DR-MV1SUC	A
DR-MV1SUS	B

△ Symbol No.	Part No.	Part Name	Description	Local	△ Symbol No.	Part No.	Part Name	Description	Local
R4009	NRSA63J-102X	MG RESISTOR	1kΩ 1/16W J		B7514	NRSA63J-0R0X	MG RESISTOR	0Ω 1/16W J	
R4010	NRSA63J-222X	MG RESISTOR	2.2kΩ 1/16W J		B7515	NRSA63J-0R0X	MG RESISTOR	0Ω 1/16W J	
R4012	NRSA63J-222X	MG RESISTOR	2.2kΩ 1/16W J		B7516	NRSA63J-0R0X	MG RESISTOR	0Ω 1/16W J	
R4013	NRSA63J-102X	MG RESISTOR	1kΩ 1/16W J		B7591	NRSA63J-0R0X	MG RESISTOR	0Ω 1/16W J	
R4015	NRSA63J-562X	MG RESISTOR	5.6kΩ 1/16W J		B7592	NRSA63J-0R0X	MG RESISTOR	0Ω 1/16W J	
R4017	NRSA63J-102X	MG RESISTOR	1kΩ 1/16W J		CN1	QGF1201C2-09	CONNECTOR	FFC/FPC (1-9)	
R6020	NRSA63J-102X	MG RESISTOR	1kΩ 1/16W J		CN501	QGF1207C1-04	CONNECTOR	FFC/FPC (1-4)	
R6021	NRSA63J-102X	MG RESISTOR	1kΩ 1/16W J		CN2001	QGF1207C1-06	CONNECTOR	FFC/FPC (1-6)	
R6030	NRSA63J-332X	MG RESISTOR	3.3kΩ 1/16W J		CN2002	QGB2532J1-02	CONNECTOR	B-B (1-2)	
R6031	NRSA63J-101X	MG RESISTOR	100Ω 1/16W J		CN2601	QGB1231L1-11	CONNECTOR	B-B (1-11)	
R6050	QRE141J-101Y	C RESISTOR	100Ω 1/4W J		CN3001	QGB2032M4-12	CONNECTOR	B-B (1-12)	
R6051	NQR0129-003X	FERRITE BEADS			CN3102	QGF1207C1-11	CONNECTOR	FFC/FPC (1-11)	
R6054	NQR0129-003X	FERRITE BEADS			CN3103	QGB1231L1-15	CONNECTOR	B-B (1-15)	
R6120	NRSA63J-102X	MG RESISTOR	1kΩ 1/16W J		CN3104	QGF1207C1-13	CONNECTOR	FFC/FPC (1-13)	
R6121	NRSA63J-102X	MG RESISTOR	1kΩ 1/16W J		CN5311	QGB1231M1-15	CONNECTOR	B-B (1-15)	
R6130	NRSA63J-332X	MG RESISTOR	3.3kΩ 1/16W J		CN7501	QGF1207C1-13	CONNECTOR	FFC/FPC (1-13)	
R6131	NRSA63J-101X	MG RESISTOR	100Ω 1/16W J		CN7503	QGF1207C1-11	CONNECTOR	FFC/FPC (1-11)	
R6502	NRSA63J-332X	MG RESISTOR	3.3kΩ 1/16W J		△ CP3002	QMFZ050-1R25X-E	FUSE	1.25A 125V	
R7202	QRE141J-221Y	C RESISTOR	220Ω 1/4W J		△ CP4002	QMFZ050-1R25X-E	FUSE	1.25A 125V	
R7203	NRSA63J-472X	MG RESISTOR	4.7kΩ 1/16W J		FW7504	QUM023-12A4A4	PARA RIBON WIRE		
R7204	QRE121J-100Y	C RESISTOR	10Ω 1/2W J		J7501	QNZ0609-001	AV JACK	DVD/VCR IN/OUT	
R7501	NRSA63J-221X	MG RESISTOR	220Ω 1/16W J		J7502	QNN0587-001	PIN JACK	DVD/VCR OUT/PUT	
R7502	NRSA63J-221X	MG RESISTOR	220Ω 1/16W J		J7503	QNN0587-002	PIN JACK	COMPONENT/VIDEO/OUT	
R7522	NRSA63J-750X	MG RESISTOR	75Ω 1/16W J		J7506	QNS0100-001	3.5 JACK	CABLE BOX	
R7523	NRSA63J-750X	MG RESISTOR	75Ω 1/16W J		JS3001	QSW0954-003	ROTARY ENCODER		
R7528	NRSA63J-560X	MG RESISTOR	56Ω 1/16W J		K2251	NRSA02J-0R0X	MG RESISTOR	0Ω 1/10W J	
R7529	NRSA63J-182X	MG RESISTOR	1.8kΩ 1/16W J		K2252	NRSA02J-0R0X	MG RESISTOR	0Ω 1/10W J	
R7538	NRSA63D-560X	MG RESISTOR	56Ω 1/16W D		K6050	NQR0129-003X	FERRITE BEADS		
R7539	NRSA63D-560X	MG RESISTOR	56Ω 1/16W D		OT1	LP31378-001A	BOSS(MECHA)3		
R7540	NRSA63D-560X	MG RESISTOR	56Ω 1/16W D		OT2	LP31379-001A	BOSS(MECHA)4	(x2)	
R7541	NRSA63J-750X	MG RESISTOR	75Ω 1/16W J		S3001	QSW0602-004	PUSH SWITCH	REC SAFETY	
R7542	NRSA63J-750X	MG RESISTOR	75Ω 1/16W J		SD1	LP31179-001A	SHILD PLATE(PRE/REC)		
R7543	NRSA63J-750X	MG RESISTOR	75Ω 1/16W J		TU6001	QAU0336-001	TUNER		
R7544	NRSA63J-750X	MG RESISTOR	75Ω 1/16W J		TU6002	QAU0336-001	TUNER		
R7561	NRSA63J-101X	MG RESISTOR	100Ω 1/16W J		W1	NRSA63J-0R0X	MG RESISTOR	0Ω 1/16W J	
R7562	NRSA63J-101X	MG RESISTOR	100Ω 1/16W J		W2	NRSA63J-0R0X	MG RESISTOR	0Ω 1/16W J	
R7563	NRSA63J-101X	MG RESISTOR	100Ω 1/16W J		W3	NRSA63J-0R0X	MG RESISTOR	0Ω 1/16W J	
R7564	NRSA63J-101X	MG RESISTOR	100Ω 1/16W J		W4	NRSA63J-0R0X	MG RESISTOR	0Ω 1/16W J	
R7565	NRSA63J-101X	MG RESISTOR	100Ω 1/16W J		W5	NRSA63J-0R0X	MG RESISTOR	0Ω 1/16W J	
R7566	NRSA63J-101X	MG RESISTOR	100Ω 1/16W J		W6	NRSA63J-0R0X	MG RESISTOR	0Ω 1/16W J	
R7575	QRE123J-271X	C RESISTOR	270Ω 1/2W J		W7	NRSA63J-0R0X	MG RESISTOR	0Ω 1/16W J	
R7576	QRE141J-101Y	C RESISTOR	100Ω 1/4W J		W9	NRSA63J-0R0X	MG RESISTOR	0Ω 1/16W J	
R7593	NRSA63J-101X	MG RESISTOR	100Ω 1/16W J		W10	NRSA63J-0R0X	MG RESISTOR	0Ω 1/16W J	
L3	QQL29BJ-100Z	P COIL	0.40Ω 10uH J		W12	NRSA63J-0R0X	MG RESISTOR	0Ω 1/16W J	
L5	QQL29BJ-100Z	P COIL	0.40Ω 10uH J		W13	NRSA63J-0R0X	MG RESISTOR	0Ω 1/16W J	
△ L6	QQL29BJ-100Z	P COIL	0.40Ω 10uH J		W14	NRSA63J-0R0X	MG RESISTOR	0Ω 1/16W J	
L7	QQL071J-120Y	COIL	1.50Ω 12uH J		W15	NRSA63J-0R0X	MG RESISTOR	0Ω 1/16W J	
△ L10	QQL29BJ-100Z	P COIL	0.40Ω 10uH J		W16	NRSA63J-0R0X	MG RESISTOR	0Ω 1/16W J	
L501	QQL29BJ-100Z	P COIL	0.40Ω 10uH J		W17	NRSA63J-0R0X	MG RESISTOR	0Ω 1/16W J	
L502	QQL29BJ-100Z	P COIL	0.40Ω 10uH J		W18	NRSA63J-0R0X	MG RESISTOR	0Ω 1/16W J	
L504	QQL231J-330Y	COIL	4.70Ω 33uH J		W21	NRSA63J-0R0X	MG RESISTOR	0Ω 1/16W J	
L2251	QQL29BJ-100Z	P COIL	0.40Ω 10uH J		W22	NRSA63J-0R0X	MG RESISTOR	0Ω 1/16W J	
L3001	QQL231J-R22Y	COIL	0.40Ω 0.22uH J		W23	NRSA63J-0R0X	MG RESISTOR	0Ω 1/16W J	
L4001	QQL29BK-1R0Z	P COIL	0.14Ω 1uH K		W24	NRSA63J-0R0X	MG RESISTOR	0Ω 1/16W J	
L6003	QQL29BK-1R0Z	P COIL	0.14Ω 1uH K		W25	NRSA63J-0R0X	MG RESISTOR	0Ω 1/16W J	
L6103	QQL29BK-1R0Z	P COIL	0.14Ω 1uH K		W26	NRSA63J-0R0X	MG RESISTOR	0Ω 1/16W J	
L7201	QQL29BJ-100Z	P COIL	0.40Ω 10uH J		W27	NRSA63J-0R0X	MG RESISTOR	0Ω 1/16W J	
L7501	QQL29BJ-100Z	P COIL	0.40Ω 10uH J		W28	NRSA63J-0R0X	MG RESISTOR	0Ω 1/16W J	
L7502	QQL29BJ-100Z	P COIL	0.40Ω 10uH J		W29	NRSA63J-0R0X	MG RESISTOR	0Ω 1/16W J	
T2051	PELN0832	OSC TRANS			W31	NRSA63J-0R0X	MG RESISTOR	0Ω 1/16W J	
B1	NRSA63J-0R0X	MG RESISTOR	0Ω 1/16W J		W32	NRSA63J-0R0X	MG RESISTOR	0Ω 1/16W J	
B4	NRSA63J-0R0X	MG RESISTOR	0Ω 1/16W J		W33	NRSA63J-0R0X	MG RESISTOR	0Ω 1/16W J	
B10	NRSA63J-0R0X	MG RESISTOR	0Ω 1/16W J		W35	NRSA63J-0R0X	MG RESISTOR	0Ω 1/16W J	
B2603	NRSA63J-0R0X	MG RESISTOR	0Ω 1/16W J		W37	NRSA63J-0R0X	MG RESISTOR	0Ω 1/16W J	
B2604	NRSA63J-0R0X	MG RESISTOR	0Ω 1/16W J		W38	NRSA63J-0R0X	MG RESISTOR	0Ω 1/16W J	
B3001	NRSA63J-0R0X	MG RESISTOR	0Ω 1/16W J		W39	NRSA63J-0R0X	MG RESISTOR	0Ω 1/16W J	
B3022	NRSA63J-0R0X	MG RESISTOR	0Ω 1/16W J		W40	NRSA63J-0R0X	MG RESISTOR	0Ω 1/16W J	
B6021	NRSA63J-0R0X	MG RESISTOR	0Ω 1/16W J		W41	NRSA63J-0R0X	MG RESISTOR	0Ω 1/16W J	
B6024	NRSA63J-0R0X	MG RESISTOR	0Ω 1/16W J		W42	NRSA63J-0R0X	MG RESISTOR	0Ω 1/16W J	
B7503	NRSA63J-0R0X	MG RESISTOR	0Ω 1/16W J		W43	NRSA63J-0R0X	MG RESISTOR	0Ω 1/16W J	
B7504	NRSA63J-0R0X	MG RESISTOR	0Ω 1/16W J		W44	NRSA63J-0R0X	MG RESISTOR	0Ω 1/16W J	
B7505	NRSA63J-0R0X	MG RESISTOR	0Ω 1/16W J		W46	NRSA63J-0R0X	MG RESISTOR	0Ω 1/16W J	
B7509	NRSA63J-0R0X	MG RESISTOR	0Ω 1/16W J		W47	NRSA63J-0R0X	MG RESISTOR	0Ω 1/16W J	
B7511	NRSA63J-0R0X	MG RESISTOR	0Ω 1/16W J		W48	NRSA63J-0R0X	MG RESISTOR	0Ω 1/16W J	
B7512	NRSA63J-0R0X	MG RESISTOR	0Ω 1/16W J		WR1	QUQ112-1112CG	FFC WIRE		
B7513	NRSA63J-0R0X	MG RESISTOR	0Ω 1/16W J		X2	QAX0739-001	CRYSTAL	3.57MHz	
					X3001	QAX0444-001	CRYSTAL	32.768kHz	
					X3002	QAX0527-001	CRYSTAL	10.00000MHz	

MODEL	MARK
DR-MV1SUC	A
DR-MV1SUS	B

### A/C HEAD BOARD ASSEMBLY <12>

Symbol No.	Part No.	Part Name	Description	Local
PW1	LPA10158-01A1	A/C HEAD BOARD ASSY		

### DEMOD BOARD ASSEMBLY <14>

Symbol No.	Part No.	Part Name	Description	Local
PW1	LPA10243-01C1	DEMOD BOARD ASSY		
IC2301	BA3308	IC		
IC6501	AN5832SA-W	IC		
C2301	QEKJ1EM-106Z	E CAPACITOR	10uF 25V M	
C2302	QEKJ1EM-106Z	E CAPACITOR	10uF 25V M	
C2303	QEKJ1EM-106Z	E CAPACITOR	10uF 25V M	
C2304	QEKJ1EM-106Z	E CAPACITOR	10uF 25V M	
C2305	QEKJ1CM-476Z	E CAPACITOR	47uF 16V M	
C6501	QEKJ1EM-106Z	E CAPACITOR	10uF 25V M	
C6502	QEKJ1HM-334Z	E CAPACITOR	0.33uF 50V M	
C6503	QEKJ1HM-335Z	E CAPACITOR	3.3uF 50V M	
C6504	NCB31CK-104X	C CAPACITOR	0.1uF 16V K	
C6506	NCB31HK-223X	C CAPACITOR	0.022uF 50V K	
C6507	NCB31CK-104X	C CAPACITOR	0.1uF 16V K	
C6508	NCB31CK-333X	C CAPACITOR	0.033uF 16V K	
C6509	QEKJ1HM-225Z	E CAPACITOR	2.2uF 50V M	
C6510	QEKJ1HM-334Z	E CAPACITOR	0.33uF 50V M	
C6511	NCB31CK-104X	C CAPACITOR	0.1uF 16V K	
C6512	NCB31CK-224X	C CAPACITOR	0.22uF 16V K	
C6514	NCB31HK-102X	C CAPACITOR	1000pF 50V K	
C6515	QEKJ1EM-475Z	E CAPACITOR	4.7uF 25V M	
C6516	QEKJ1HM-225Z	E CAPACITOR	2.2uF 50V M	
C6519	QEKJ1CM-476Z	E CAPACITOR	47uF 16V M	
C6520	QEKJ1HM-225Z	E CAPACITOR	2.2uF 50V M	
C6521	QEKJ1EM-106Z	E CAPACITOR	10uF 25V M	
C6522	QEKJ1EM-106Z	E CAPACITOR	10uF 25V M	
C6523	QEKJ1HM-225Z	E CAPACITOR	2.2uF 50V M	
R2301	NRSA63J-123X	MG RESISTOR	12kΩ 1/16W J	
R2302	NRSA63J-181X	MG RESISTOR	180Ω 1/16W J	
R2303	NRSA63J-123X	MG RESISTOR	12kΩ 1/16W J	
R2304	NRSA63J-181X	MG RESISTOR	180Ω 1/16W J	
R2305	NRSA63J-101X	MG RESISTOR	100Ω 1/16W J	
R2306	NRSA63J-103X	MG RESISTOR	10kΩ 1/16W J	
R2307	NRSA63J-222X	MG RESISTOR	2.2kΩ 1/16W J	
R2308	NRSA63J-224X	MG RESISTOR	220kΩ 1/16W J	
R2309	NRSA63J-222X	MG RESISTOR	2.2kΩ 1/16W J	
R2310	NRSA63J-103X	MG RESISTOR	10kΩ 1/16W J	
R2311	NRSA63J-101X	MG RESISTOR	100Ω 1/16W J	
R2312	NRSA63J-822X	MG RESISTOR	8.2kΩ 1/16W J	
R6501	NRSA63J-103X	MG RESISTOR	10kΩ 1/16W J	
R6503	NRSA63J-332X	MG RESISTOR	3.3kΩ 1/16W J	
R6504	NRSA63J-102X	MG RESISTOR	1kΩ 1/16W J	
R6505	NRSA63J-102X	MG RESISTOR	1kΩ 1/16W J	
R6508	NRSA63J-184X	MG RESISTOR	180kΩ 1/16W J	
R6509	NRSA63J-0R0X	MG RESISTOR	0Ω 1/16W J	
R6510	NRSA63J-103X	MG RESISTOR	10kΩ 1/16W J	
R6511	NRSA63J-0R0X	MG RESISTOR	0Ω 1/16W J	
R6512	NRSA63J-103X	MG RESISTOR	10kΩ 1/16W J	
BK1	LP40425-001A	BRACKET(BOARD ASSY)		
CN2301	QGF1207F1-11	CONNECTOR	FFC/FPC (1-11)	
CN6701	QGG2502K1-09	CONNECTOR	(1-9)	
W1	NRSA63J-0R0X	MG RESISTOR	0Ω 1/16W J	
W2	NRSA63J-0R0X	MG RESISTOR	0Ω 1/16W J	
W3	NRSA63J-0R0X	MG RESISTOR	0Ω 1/16W J	
W4	NRSA63J-0R0X	MG RESISTOR	0Ω 1/16W J	
W5	NRSA63J-0R0X	MG RESISTOR	0Ω 1/16W J	
W6	NRSA63J-0R0X	MG RESISTOR	0Ω 1/16W J	

### OSD BOARD ASSEMBLY <17>

Symbol No.	Part No.	Part Name	Description	Local
PW1	LPA10243-01C3	OSD BOARD ASSY		
IC201	LC74785N-9762	IC (OSD)		
D201	1SS133-T2	DIODE		
D202	1SS133-T2	DIODE		
D203	1SS133-T2	DIODE		
D204	1SS133-T2	DIODE		
C201	NCB31EK-103X	C CAPACITOR	0.01uF 25V K	
C202	NCB21CK-105X	C CAPACITOR	1uF 16V K	
C203	NCB31EK-103X	C CAPACITOR	0.01uF 25V K	
C204	QEKJ1HM-105Z	E CAPACITOR	1uF 50V M	
C208	NDC31HJ-680X	C CAPACITOR	68pF 50V J	
C209	QEKJ0JM-337Z	E CAPACITOR	330uF 6.3V M	
C211	NCB31EK-103X	C CAPACITOR	0.01uF 25V K	
C212	NDC31HJ-330X	C CAPACITOR	33pF 50V J	
C213	NDC31HJ-330X	C CAPACITOR	33pF 50V J	
C219	NCB31CK-224X	C CAPACITOR	0.22uF 16V K	
C220	NCB31CK-224X	C CAPACITOR	0.22uF 16V K	
R202	NRSA63J-103X	MG RESISTOR	10kΩ 1/16W J	
R203	QRE141J-102Y	C RESISTOR	1kΩ 1/4W J	
R207	NRSA63J-0R0X	MG RESISTOR	0Ω 1/16W J	
R208	NRSA63J-103X	MG RESISTOR	10kΩ 1/16W J	
R209	NRSA63J-0R0X	MG RESISTOR	0Ω 1/16W J	
R210	NRSA63J-103X	MG RESISTOR	10kΩ 1/16W J	
R211	NRSA63J-0R0X	MG RESISTOR	0Ω 1/16W J	
R212	NRSA63J-103X	MG RESISTOR	10kΩ 1/16W J	
R216	NRSA63J-0R0X	MG RESISTOR	0Ω 1/16W J	
R217	NRSA63J-102X	MG RESISTOR	1kΩ 1/16W J	
R218	NRSA63J-222X	MG RESISTOR	2.2kΩ 1/16W J	
L201	QQL29BK-1R0Z	P COIL	0.14Ω 1uH K	
L206	QQL29BJ-220Z	P COIL	0.65Ω 22uH J	
B201	NRSA63J-0R0X	MG RESISTOR	0Ω 1/16W J	
B203	NRSA63J-0R0X	MG RESISTOR	0Ω 1/16W J	
B205	NRSA63J-0R0X	MG RESISTOR	0Ω 1/16W J	
BK1	LP40425-001A	BRACKET(BOARD ASSY)		
CN201	QGG2502K1-14	CONNECTOR	(1-14)	
W101	NRSA63J-0R0X	MG RESISTOR	0Ω 1/16W J	
W102	NRSA63J-0R0X	MG RESISTOR	0Ω 1/16W J	
W103	NRSA63J-0R0X	MG RESISTOR	0Ω 1/16W J	

### OPERATION JACK BOARD ASSEMBLY <27>

Symbol No.	Part No.	Part Name	Description	Local
PW1	LPA10248-02C5	OPERATION JACK BOARD ASSY		
D7204	RD6.8ES/B1/-T2	Z DIODE		
D7204	or MTZJ6.8A-T2	Z DIODE		
D7221	SLA-580BC3T3F	LED		
D7221	or SLA-580BCT3F	LED		
D7221	or SDPB50A0/DEGH/	LED		
D7222	SLR-325VC-T	LED		
D7222	or LTL-816EE-T	LED		
D7223	SLR-325MC-T	LED		
D7223	or LTL-816GE-T	LED		
D7223	or SLR-343MC-T	LED		
D7224	SLR-325VC-T	LED		
D7224	or LTL-816EE-T	LED		
C7206	NCB21HK-103X	C CAPACITOR	0.01uF 50V K	
C7221	QCB1HK-103Y	C CAPACITOR	0.01uF 50V K	
R7202	QRE141J-750Y	C RESISTOR	75Ω 1/4W J	
R7206	NRSA02J-750X	MG RESISTOR	75Ω 1/10W J	
R7207	NRSA02J-750X	MG RESISTOR	75Ω 1/10W J	
R7221	QRE141J-101Y	C RESISTOR	100Ω 1/4W J	
R7222	NRSA02J-331X	MG RESISTOR	330Ω 1/10W J	
R7223	NRSA02J-331X	MG RESISTOR	330Ω 1/10W J	



MODEL	MARK
DR-MV1SUC	A
DR-MV1SUS	B

△ Symbol No.	Part No.	Part Name	Description	Local
R7224	NRSA02J-331X	MG RESISTOR	330Ω 1/10W J	
R7225	QRE141J-103Y	C RESISTOR	10kΩ 1/4W J	
CN7201	QGF1209F1-13	CONNECTOR	FFC/FPC (1-13)	
CN7202	QGD2503C1-05	CONNECTOR	(1-5)	
J7201	QNN0591-001	PIN JACK	FRONT AV	
J7204	QND0084-001	S JACK	FRONT S-VIDEO	
S7216	QSW0381-001Z	TACT SWITCH	VCR_EJECT	
S7217	QSW0381-001Z	TACT SWITCH	VCR/DVD	
S7218	QSW0381-001Z	TACT SWITCH	POWER	
W71	NRSA02J-0R0X	MG RESISTOR	0Ω 1/10W J	
W72	NRSA02J-0R0X	MG RESISTOR	0Ω 1/10W J	

### SWITCH DISPLAY BOARD ASSEMBLY <28>

△ Symbol No.	Part No.	Part Name	Description	Local
PW1	LPA10248-02C4	SWITCH DISPLAY BOARD ASSY		
IC7001	UPD16315GB-3BS	IC		
IC7001	or PT6315	IC		
IC7002	GP1UM281XK	IR DETECT UNIT	38kHz	
IC7002	or PNA4652M00XB	IR DETECT UNIT		
D7001	1SS133-T2	DIODE		
D7001	or 1SS270A-T2	SI DIODE		
D7002	1SS133-T2	DIODE		
D7002	or 1SS270A-T2	SI DIODE		
D7003	1SS133-T2	DIODE		
D7003	or 1SS270A-T2	SI DIODE		
D7004	1SS133-T2	DIODE		
D7004	or 1SS270A-T2	SI DIODE		
D7005	1SS133-T2	DIODE		
D7005	or 1SS270A-T2	SI DIODE		
D7012	1SS133-T2	DIODE		
D7012	or 1SS270A-T2	SI DIODE		
D7013	1SS133-T2	DIODE		
D7013	or 1SS270A-T2	SI DIODE		
D7014	1SS133-T2	DIODE		
D7014	or 1SS270A-T2	SI DIODE		
D7015	1SS133-T2	DIODE		
D7015	or 1SS270A-T2	SI DIODE		
D7021	RD9.1ES/B2-T2	Z DIODE		
D7021	or MTZJ9.1B-T2	Z DIODE		
D7041	SLR-325VC-T	LED		
D7041	or LTL-816EE-T	LED		
D7042	SLR-325MC-T	LED		
D7042	or LTL-816GE-T	LED		
D7042	or SLR-343MC-T	LED		
D7043	SLR-325VC-T	LED		
D7043	or LTL-816EE-T	LED		
D7044	SLR-325MC-T	LED		
D7044	or LTL-816GE-T	LED		
D7044	or SLR-343MC-T	LED		
D7045	SLA-580BC3T3F	LED		
D7045	or SLA-580BCT3F	LED		
D7045	or SDPB50A0/DEGH/	LED		
D7046	SLR-325VC-T	LED		
D7046	or LTL-816EE-T	LED		
D7047	SLR-325MC-T	LED		
D7047	or LTL-816GE-T	LED		
D7047	or SLR-343MC-T	LED		
C7001	NCB21EK-104X	C CAPACITOR	0.1uF 25V K	
C7002	QCFB1HZ-104Y	C CAPACITOR	0.1uF 50V Z	
C7003	QEKJ1HM-106Z	E CAPACITOR	10uF 50V M	
C7006	QEKCOJM-227Z	E CAPACITOR	220uF 6.3V M	
C7008	QERF1AM-227Z	E CAPACITOR	220uF 10V M	
C7010	NCF31HZ-473X	C CAPACITOR	0.047uF 50V Z	
C7011	NCF31HZ-473X	C CAPACITOR	0.047uF 50V Z	
C7013	QCB1HK-103Y	C CAPACITOR	0.01uF 50V K	
R7001	QRE141J-103Y	C RESISTOR	10kΩ 1/4W J	
R7002	QRE141J-103Y	C RESISTOR	10kΩ 1/4W J	
R7003	QRE141J-823Y	C RESISTOR	82kΩ 1/4W J	

△ Symbol No.	Part No.	Part Name	Description	Local
R7005	QRE141J-472Y	C RESISTOR	4.7kΩ 1/4W J	
R7006	QRE141J-472Y	C RESISTOR	4.7kΩ 1/4W J	
R7007	QRE141J-102Y	C RESISTOR	1kΩ 1/4W J	
R7009	QRE141J-103Y	C RESISTOR	10kΩ 1/4W J	
R7010	NRSA02J-103X	MG RESISTOR	10kΩ 1/10W J	
R7013	QRE141J-333Y	C RESISTOR	33kΩ 1/4W J	
R7014	QRE141J-333Y	C RESISTOR	33kΩ 1/4W J	
R7015	NRSA02J-102X	MG RESISTOR	1kΩ 1/10W J	
R7041	QRE141J-331Y	C RESISTOR	330Ω 1/4W J	
R7042	QRE141J-331Y	C RESISTOR	330Ω 1/4W J	
R7043	QRE141J-331Y	C RESISTOR	330Ω 1/4W J	
R7044	QRE141J-181Y	C RESISTOR	180Ω 1/4W J	
R7045	QRE141J-101Y	C RESISTOR	100Ω 1/4W J	
R7046	QRE141J-331Y	C RESISTOR	330Ω 1/4W J	
R7047	QRE141J-181Y	C RESISTOR	180Ω 1/4W J	
R7053	QRE141J-103Y	C RESISTOR	10kΩ 1/4W J	

△ Symbol No.	Part No.	Part Name	Description	Local
CN7001	QGF1207C1-11	CONNECTOR	FFC/FPC (1-11)	
CN7002	QGF1209C1-04	CONNECTOR	FFC/FPC (1-4)	
DI7001	QLF0121-001	FL TUBE		
FW7001	QUM025-07A4BF	PARA RIBON WIRE		
HD1	PQ34949-1-1	FDP HOLDER(L)		
HD2	PQ34950-1-1	FDP HOLDER(R)		
OT1	LP30002-0F8A	SPACER		
S7002	QSW0381-001Z	TACT SWITCH	CH+	
S7004	QSW0381-001Z	TACT SWITCH	VCR-DVD	
S7005	QSW0381-001Z	TACT SWITCH	DUBBING	
S7012	QSW0381-001Z	TACT SWITCH	DVD-VCR	
S7013	QSW0381-001Z	TACT SWITCH	FF	
S7014	QSW0381-001Z	TACT SWITCH	PAUSE	
S7015	QSW0381-001Z	TACT SWITCH	STOP	
S7022	QSW0381-001Z	TACT SWITCH	CH-	
S7023	QSW0381-001Z	TACT SWITCH	REC MODE	
S7024	QSW0381-001Z	TACT SWITCH	REC-LINK	
S7032	QSW0381-001Z	TACT SWITCH	OPEN/CLOSE	
S7033	QSW0381-001Z	TACT SWITCH	REW	
S7034	QSW0381-001Z	TACT SWITCH	REC	
S7035	QSW0381-001Z	TACT SWITCH	PLAY	
W41	NRSA02J-0R0X	MG RESISTOR	0Ω 1/10W J	
W43	NRSA02J-0R0X	MG RESISTOR	0Ω 1/10W J	
W44	NRSA02J-0R0X	MG RESISTOR	0Ω 1/10W J	

### JACK BOARD ASSEMBLY <36>

△ Symbol No.	Part No.	Part Name	Description	Local
PW1	LPA10248-01C3	JACK BOARD ASSY		
B4121	NRSA02J-0R0X	MG RESISTOR	0Ω 1/10W J	
B4122	NRSA02J-0R0X	MG RESISTOR	0Ω 1/10W J	
B4123	NRSA02J-0R0X	MG RESISTOR	0Ω 1/10W J	
B4124	NRSA02J-0R0X	MG RESISTOR	0Ω 1/10W J	
CN4104	QGB2027M1-10S	CONNECTOR	B-B (1-10)	
J4112	QNZ0675-001	D CONNECTOR		
K4101	NRSA02J-0R0X	MG RESISTOR	0Ω 1/10W J	
K4102	NRSA02J-0R0X	MG RESISTOR	0Ω 1/10W J	
K4103	NRSA02J-0R0X	MG RESISTOR	0Ω 1/10W J	
K4104	NRSA02J-0R0X	MG RESISTOR	0Ω 1/10W J	
OT1	QZW0021-001	PC SUPPORT		
W31	NRSA02J-0R0X	MG RESISTOR	0Ω 1/10W J	

### LOADING MOTOR BOARD ASSEMBLY <55>

△ Symbol No.	Part No.	Part Name	Description	Local
PW1	LPA10158-01A2	LOADING MOTOR BOARD ASSY		

MODEL	MARK
DR-MV1SUC	A
DR-MV1SUS	B

## JUNCTION BOARD ASSEMBLY <92>

Symbol No.	Part No.	Part Name	Description	Local
	C5506	NCB21HK-471X	C CAPACITOR	470pF 50V K
	C5507	NCB21AK-105X	C CAPACITOR	1uF 10V K
	C5508	QETN1AM-107Z	E CAPACITOR	100uF 10V M
	C5509	NCB21HK-471X	C CAPACITOR	470pF 50V K
	C5510	NCB21AK-105X	C CAPACITOR	1uF 10V K
	C5511	QETN0JM-107Z	E CAPACITOR	100uF 6.3V M
	C5512	NCB21HK-471X	C CAPACITOR	470pF 50V K
	C5513	NCB21AK-105X	C CAPACITOR	1uF 10V K
	C5514	QETN0JM-107Z	E CAPACITOR	100uF 6.3V M
	C5515	NCB21HK-471X	C CAPACITOR	470pF 50V K
	C7101	NCB21HK-103X	C CAPACITOR	0.01uF 50V K
	C7102	NCB21HK-103X	C CAPACITOR	0.01uF 50V K
	C7103	NCF21CZ-105X	C CAPACITOR	1uF 16V Z
	C7104	QEK1CM-226Z	E CAPACITOR	22uF 16V M
	C7105	NCF21CZ-105X	C CAPACITOR	1uF 16V Z
	C7106	NCF21CZ-105X	C CAPACITOR	1uF 16V Z
	C7107	NCF21CZ-105X	C CAPACITOR	1uF 16V Z
	C7109	NCB21HK-103X	C CAPACITOR	0.01uF 50V K
	C7112	QEK0JM-227Z	E CAPACITOR	220uF 6.3V M
	C7123	NDC21HJ-120X	C CAPACITOR	12pF 50V J
	C7124	NDC21HJ-6R0X	C CAPACITOR	6pF 50V J
	C7141	NDC21HJ-330X	C CAPACITOR	33pF 50V J
	C7142	NDC21HJ-330X	C CAPACITOR	33pF 50V J
	C8001	NDC21HJ-101X	C CAPACITOR	100pF 50V J
	C8003	NDC21HJ-101X	C CAPACITOR	100pF 50V J
	C8005	NDC21HJ-101X	C CAPACITOR	100pF 50V J
	C8007	NDC21HJ-101X	C CAPACITOR	100pF 50V J
	C8009	QEK1EM-106Z	E CAPACITOR	10uF 25V M
	C8010	QEK1EM-106Z	E CAPACITOR	10uF 25V M
	C8011	QEK1HM-475Z	E CAPACITOR	4.7uF 50V M
	C8012	NCB21HK-104X	C CAPACITOR	0.1uF 50V K
	C8013	QEK0JM-107Z	E CAPACITOR	100uF 6.3V M
	C8014	NCB21HK-104X	C CAPACITOR	0.1uF 50V K
	C8015	QEK0JM-107Z	E CAPACITOR	100uF 6.3V M
	C8016	NCB21HK-104X	C CAPACITOR	0.1uF 50V K
	C8051	QEK0JM-337Z	E CAPACITOR	330uF 6.3V M
	C8052	QEK1CM-107Z	E CAPACITOR	100uF 16V M
	C8053	NCB21HK-104X	C CAPACITOR	0.1uF 50V K
	C8054	QEK0JM-337Z	E CAPACITOR	330uF 6.3V M
	C8055	NCB21HK-104X	C CAPACITOR	0.1uF 50V K
	C8056	QEK1CM-107Z	E CAPACITOR	100uF 16V M
	C8057	QEK1CM-107Z	E CAPACITOR	100uF 16V M
	C8201	QEK1CM-476Z	E CAPACITOR	47uF 16V M
	C8202	NCB21HK-471X	C CAPACITOR	470pF 50V K
	C8203	NCB21HK-471X	C CAPACITOR	470pF 50V K
	C8204	NCB21HK-472X	C CAPACITOR	4700pF 50V K
	C8205	NCB21HK-471X	C CAPACITOR	470pF 50V K
	C8206	NCB21HK-472X	C CAPACITOR	4700pF 50V K
	C8207	NCB21HK-471X	C CAPACITOR	470pF 50V K
	C8208	QEK1CM-476Z	E CAPACITOR	47uF 16V M
	C8209	NCB21HK-104X	C CAPACITOR	0.1uF 50V K
	C8210	QEK0JM-337Z	E CAPACITOR	330uF 6.3V M
	C8211	NCB21HK-104X	C CAPACITOR	0.1uF 50V K
	C8231	QEK0JM-107Z	E CAPACITOR	100uF 6.3V M
	C8232	NCB21HK-104X	C CAPACITOR	0.1uF 50V K
	R5501	QRE121J-821Y	C RESISTOR	820Ω 1/2W J
	R5502	QRE121J-681Y	C RESISTOR	680Ω 1/2W J
	R5503	NRSA02J-562X	MG RESISTOR	5.6kΩ 1/10W J
	R5504	NRSA02J-102X	MG RESISTOR	1kΩ 1/10W J
	R5505	NRSA02J-222X	MG RESISTOR	2.2kΩ 1/10W J
	R7101	NRSA02J-122X	MG RESISTOR	1.2kΩ 1/10W J
	R7102	NRSA02J-102X	MG RESISTOR	1kΩ 1/10W J
	R7145	NRSA02J-200X	MG RESISTOR	20Ω 1/10W J
	R7146	NRSA02J-0R0X	MG RESISTOR	0Ω 1/10W J
	R7147	NRSA02J-0R0X	MG RESISTOR	0Ω 1/10W J
	R7148	NRSA02J-200X	MG RESISTOR	20Ω 1/10W J
	R7149	NRSA02J-200X	MG RESISTOR	20Ω 1/10W J
	R7150	NRSA02J-200X	MG RESISTOR	20Ω 1/10W J
	R7151	NRSA02J-200X	MG RESISTOR	20Ω 1/10W J
	R7161	NRSA02J-0R0X	MG RESISTOR	0Ω 1/10W J
	R7162	NRSA02J-0R0X	MG RESISTOR	0Ω 1/10W J
	R8001	NRSA02J-103X	MG RESISTOR	10kΩ 1/10W J
	R8002	NRSA02J-103X	MG RESISTOR	10kΩ 1/10W J
	R8003	NRSA02J-103X	MG RESISTOR	10kΩ 1/10W J
	R8004	NRSA02J-103X	MG RESISTOR	10kΩ 1/10W J
	R8005	NRSA02J-103X	MG RESISTOR	10kΩ 1/10W J
	R8006	NRSA02J-103X	MG RESISTOR	10kΩ 1/10W J

Symbol No.	Part No.	Part Name	Description	Local
PW1	LPA10248-02C2	JUNCTION BOARD ASSY		
IC5501	MM1662GH-X	IC		
IC5502	MM1565AF-X	IC	5.0V	
IC5503	MM1565AF-X	IC	5.0V	
IC5504	MM1563EF-X	IC	3.4V	
IC5505	MM1563DF-X	IC	3.3V	
IC7101	MM1623XF-X	IC		
IC8001	BA15218F-XE	IC		
IC8001	or RC4558D-X	IC		
IC8002	AK5381VTP-X	IC		
IC8201	BA15218F-XE	IC		
IC8201	or RC4558D-X	IC		
IC8202	AK4381VT-X	IC		
IC8202	or AK4385VT-X	IC		
Q5501	2SD1819A/QRS/-X	TRANSISTOR		
Q5501	or 2SC4081/QRS/-X	TRANSISTOR		
Q5501	or 2PC4081/R/-X	TRANSISTOR		
Q5502	UN5111-X	DIGI TRANSISTOR		
Q5502	or DTA114EUA-X	DIGI TRANSISTOR		
Q5502	or PDTA114EU-X	DIGI TRANSISTOR		
Q5502	or RN2302-X	DIGI TRANSISTOR		
Q5502	or RT1P141M-X	DIGI TRANSISTOR		
Q5503	2SD2144S/UV/-T	TRANSISTOR		
Q5503	or 2SC3576-JVC-T	TRANSISTOR		
Q5504	UN5211-X	DIGI TRANSISTOR		
Q5504	or DTC114EUA-X	DIGI TRANSISTOR		
Q5504	or PDTC114EU-X	DIGI TRANSISTOR		
Q5504	or RN1302-X	DIGI TRANSISTOR		
Q5504	or RT1N141M-X	DIGI TRANSISTOR		
Q5505	UN5111-X	DIGI TRANSISTOR		
Q5505	or DTA114EUA-X	DIGI TRANSISTOR		
Q5505	or PDTA114EU-X	DIGI TRANSISTOR		
Q5505	or RN2302-X	DIGI TRANSISTOR		
Q5505	or RT1P141M-X	DIGI TRANSISTOR		
Q5506	UN5211-X	DIGI TRANSISTOR		
Q5506	or DTC114EUA-X	DIGI TRANSISTOR		
Q5506	or PDTC114EU-X	DIGI TRANSISTOR		
Q5506	or RN1302-X	DIGI TRANSISTOR		
Q5506	or RT1N141M-X	DIGI TRANSISTOR		
Q7101	2SB1218A/QR/-X	TRANSISTOR		
Q7101	or 2SA1576A/QR/-X	TRANSISTOR		
Q7101	or 2PA1576R/-X	TRANSISTOR		
Q8001	2SC4081/QRS/-X	TRANSISTOR		
Q8001	or 2PC4081/R/-X	TRANSISTOR		
Q8001	or 2SD1819A/QRS/-X	TRANSISTOR		
Q8002	2SC4081/QRS/-X	TRANSISTOR		
Q8002	or 2PC4081/R/-X	TRANSISTOR		
Q8002	or 2SD1819A/QRS/-X	TRANSISTOR		
Q8003	DTC144WUA-X	DIGI TRANSISTOR		
Q8003	or PDTC144WU-X	DIGI TRANSISTOR		
Q8003	or UN521E-X	DIGI TRANSISTOR		
Q8003	or RN1309-X	DIGI TRANSISTOR		
Q8004	DTC144WUA-X	DIGI TRANSISTOR		
Q8004	or PDTC144WU-X	DIGI TRANSISTOR		
Q8004	or UN521E-X	DIGI TRANSISTOR		
Q8004	or RN1309-X	DIGI TRANSISTOR		
Q8005	DTA144WUA-X	DIGI TRANSISTOR		
Q8005	or PDTA144WU-X	DIGI TRANSISTOR		
Q8005	or UN511E-X	DIGI TRANSISTOR		
Q8005	or RN2309-X	DIGI TRANSISTOR		
D5501	1A3G-T2	SI DIODE		
D5501	or 10EDB20-T2	SI DIODE		
D5501	or ERA15-02-T2	SI DIODE		
D5502	1SS133-T2	DIODE		
D5502	or 1SS270A-T2	SI DIODE		
D5503	MTZJ27C-T2	Z DIODE		
D5503	or RD27ES/B3/-T2	Z DIODE		
C5501	NCB21AK-105X	C CAPACITOR	1uF 10V K	
C5502	QETN0JM-107Z	E CAPACITOR	100uF 6.3V M	
C5503	NCB21HK-471X	C CAPACITOR	470pF 50V K	
C5504	NCB21AK-105X	C CAPACITOR	1uF 10V K	
C5505	QETN1AM-107Z	E CAPACITOR	100uF 10V M	

MODEL	MARK
DR-MV1SUC	A
DR-MV1SUS	B

△ Symbol No.	Part No.	Part Name	Description	Local
R8007	NRSA02J-103X	MG RESISTOR	10kΩ 1/10W J	
R8008	NRSA02J-103X	MG RESISTOR	10kΩ 1/10W J	
R8009	NRSA02J-152X	MG RESISTOR	1.5kΩ 1/10W J	
R8010	NRSA02J-152X	MG RESISTOR	1.5kΩ 1/10W J	
R8011	NRSA02J-152X	MG RESISTOR	1.5kΩ 1/10W J	
R8012	NRSA02J-152X	MG RESISTOR	1.5kΩ 1/10W J	
R8013	NRSA02J-470X	MG RESISTOR	47Ω 1/10W J	
R8014	NRSA02J-470X	MG RESISTOR	47Ω 1/10W J	
R8015	NRSA02J-470X	MG RESISTOR	47Ω 1/10W J	
R8016	NRSA02J-470X	MG RESISTOR	47Ω 1/10W J	
R8017	NRSA02J-103X	MG RESISTOR	10kΩ 1/10W J	
R8018	NRSA02J-123X	MG RESISTOR	12kΩ 1/10W J	
R8019	NRSA02J-223X	MG RESISTOR	22kΩ 1/10W J	
R8051	NRSA02J-221X	MG RESISTOR	220Ω 1/10W J	
R8052	NRSA02J-0R0X	MG RESISTOR	0Ω 1/10W J	
R8201	NRSA02J-471X	MG RESISTOR	470Ω 1/10W J	
R8202	NRSA02J-273X	MG RESISTOR	27kΩ 1/10W J	
R8203	NRSA02J-512X	MG RESISTOR	5.1kΩ 1/10W J	
R8204	NRSA02J-121X	MG RESISTOR	120Ω 1/10W J	
R8205	NRSA02J-121X	MG RESISTOR	120Ω 1/10W J	
R8206	NRSA02J-512X	MG RESISTOR	5.1kΩ 1/10W J	
R8207	NRSA02J-512X	MG RESISTOR	5.1kΩ 1/10W J	
R8208	NRSA02J-121X	MG RESISTOR	120Ω 1/10W J	
R8209	NRSA02J-121X	MG RESISTOR	120Ω 1/10W J	
R8210	NRSA02J-512X	MG RESISTOR	5.1kΩ 1/10W J	
R8211	NRSA02J-273X	MG RESISTOR	27kΩ 1/10W J	
R8212	NRSA02J-471X	MG RESISTOR	470Ω 1/10W J	
R8213	NRSA02J-470X	MG RESISTOR	47Ω 1/10W J	
R8214	NRSA02J-470X	MG RESISTOR	47Ω 1/10W J	
R8215	NRSA02J-470X	MG RESISTOR	47Ω 1/10W J	
R8216	NRSA02J-470X	MG RESISTOR	47Ω 1/10W J	
R8217	NRSA02J-103X	MG RESISTOR	10kΩ 1/10W J	
R8219	NRSA02J-432X	MG RESISTOR	4.3kΩ 1/10W J	
R8220	NRSA02J-432X	MG RESISTOR	4.3kΩ 1/10W J	
R8221	NRSA02J-432X	MG RESISTOR	4.3kΩ 1/10W J	
R8222	NRSA02J-432X	MG RESISTOR	4.3kΩ 1/10W J	
R8231	NRSA02J-222X	MG RESISTOR	2.2kΩ 1/10W J	
R8232	NRSA02J-222X	MG RESISTOR	2.2kΩ 1/10W J	
R8233	NRSA02J-102X	MG RESISTOR	1kΩ 1/10W J	
L7101	QQL29BJ-100Z	P COIL	0.40Ω 10uH J	
L7102	QQL071J-6R8Y	COIL	1.20Ω 6.8uH J	
L8001	QQL29BJ-220Z	P COIL	0.65Ω 22uH J	
L8002	QQL29BJ-220Z	P COIL	0.65Ω 22uH J	
B7101	NRSA02J-0R0X	MG RESISTOR	0Ω 1/10W J	
B7107	NRSA02J-0R0X	MG RESISTOR	0Ω 1/10W J	
B7112	NRSA02J-0R0X	MG RESISTOR	0Ω 1/10W J	
B7113	NRSA02J-0R0X	MG RESISTOR	0Ω 1/10W J	
B7115	NRSA02J-0R0X	MG RESISTOR	0Ω 1/10W J	
B7118	NRSA02J-0R0X	MG RESISTOR	0Ω 1/10W J	
CN5501	QGB1231M1-15	CONNECTOR	B-B (1-15)	
CN7102	QGB1231M1-15	CONNECTOR	B-B (1-15)	
CN7103	QGF1207C1-04	CONNECTOR	FFC/FPC (1-4)	
CN7104	QGF1207C1-04	CONNECTOR	FFC/FPC (1-4)	
CN7105	QGF1207C1-04	CONNECTOR	FFC/FPC (1-4)	
CN7106	QGF1016C3-04	CONNECTOR	FFC/FPC (1-4)	
CN7107	QGF1207C1-13	CONNECTOR	FFC/FPC (1-13)	
CN7108	QGB2027M6-28S	CONNECTOR	B-B (1-28)	
CN7109	QGB2027M6-28S	CONNECTOR	B-B (1-28)	
CN8001	QGB1231M1-11	CONNECTOR	B-B (1-11)	
K7101	NQR0129-002X	FERRITE BEADS		
K8001	NRSA02J-0R0X	MG RESISTOR	0Ω 1/10W J	
K8002	NRSA02J-0R0X	MG RESISTOR	0Ω 1/10W J	
K8201	NRSA02J-0R0X	MG RESISTOR	0Ω 1/10W J	
K8202	NRSA02J-4R7X	MG RESISTOR	4.7Ω 1/10W J	
W1	NRSA02J-0R0X	MG RESISTOR	0Ω 1/10W J	
W2	NRSA02J-0R0X	MG RESISTOR	0Ω 1/10W J	
W5	NRSA02J-0R0X	MG RESISTOR	0Ω 1/10W J	
W6	NRSA02J-0R0X	MG RESISTOR	0Ω 1/10W J	
W9	NRSA02J-0R0X	MG RESISTOR	0Ω 1/10W J	
W10	NRSA02J-0R0X	MG RESISTOR	0Ω 1/10W J	
W11	NRSA02J-0R0X	MG RESISTOR	0Ω 1/10W J	
W12	NRSA02J-0R0X	MG RESISTOR	0Ω 1/10W J	
W13	NRSA02J-0R0X	MG RESISTOR	0Ω 1/10W J	
W14	NRSA02J-0R0X	MG RESISTOR	0Ω 1/10W J	

### JACK BOARD ASSEMBLY <94>

△ Symbol No.	Part No.	Part Name	Description	Local
PW1	LPA10243-01C2	JACK BOARD ASSY		
IC8501	74VHCT08ASJ-X	IC		
IC8501	or SN74AHCT08NS-X	IC		
C8401	QEKJ0JM-107Z	E CAPACITOR	100uF 6.3V M	
C8402	NCB31CK-104X	C CAPACITOR	0.1uF 16V K	
C8501	QEKJ0JM-107Z	E CAPACITOR	100uF 6.3V M	
C8502	NCB31CK-104X	C CAPACITOR	0.1uF 16V K	
C8503	QEKJ1HM-475Z	E CAPACITOR	4.7uF 50V M	
C8504	NDC31HJ-151X	C CAPACITOR	150pF 50V J	
C8506	NCB31CK-104X	C CAPACITOR	0.1uF 16V K	
R8501	NRSA63J-4R7X	MG RESISTOR	4.7Ω 1/16W J	
R8502	NRSA63J-301X	MG RESISTOR	300Ω 1/16W J	
R8503	NRSA63J-301X	MG RESISTOR	300Ω 1/16W J	
R8504	NRSA63J-820X	MG RESISTOR	82Ω 1/16W J	
R8505	NRSA63J-100X	MG RESISTOR	10Ω 1/16W J	
R8506	NRSA63J-100X	MG RESISTOR	10Ω 1/16W J	
L8501	QQL071J-1R0Y	COIL	0.46Ω 1uH J	
CN8501	QGD2503C1-03	CONNECTOR	(1-3)	
J8401	GP1FA313TZ	OPT TRANSMITTER	OPTICAL	
J8501	QNN0096-001	PIN JACK	COAXIAL	
K8401	NQR0227-004X	FERRITE BEADS		
K8501	NQR0227-004X	FERRITE BEADS		

# JVC Service Bulletin

**SUBJECT:** TO IMPROVE PICTURE AND SOUND NOISE

**DATE:** MARCH, 2005

<p><b>Model &amp; Manual No.</b> Shown below</p>	<p><b>Performed at factory</b></p>	<p><b>Priority</b>  <input type="checkbox"/> S. All Products.  <input type="checkbox"/> A. Items in JVC/Dealer stock/Service return goods.  <input type="checkbox"/> B. JVC stock/Units returned for service.  <input type="checkbox"/> C. Sold items returned for service.  <input checked="" type="checkbox"/> D. Only Units related to this bulletin.  <input type="checkbox"/> E. Others.</p>
<p><b>Reference Information</b> Revise one of the wire position of page 7/9 due to miss print of "-4"</p>		

**<Models>**

- |                        |                        |                         |
|------------------------|------------------------|-------------------------|
| DR-M10SUS : No. XA019  | DR-M10BE : No. XA020   | DR-M10SAA : No. YD025   |
| DR-MV1SUS : No. YD006  | DR-MH20SE : No. YD027  | DR-M10SAA2 : No. YD025B |
| DR-MH20SUS : No. YD026 | DR-MH30SE : No. YD027  | DR-MV1SAA : No. YD036   |
| DR-MH30SUS : No. YD026 | DR-M10SEU : No. XA020  | DR-MH30SAA : No. YD044  |
| DR-MX1SUS : No. YD041  | DR-MV1SEU : No. YD014  | DR-M10SAG : No. YD025   |
| SR-MV30US : No. YD012  | DR-MV1BEU : No. YD014  | DR-MH30SAG : No. YD044  |
| SR-MV50US : No. YD045  | DR-M10SEK : No. XA020  | DR-MV1SAS : No. YD036   |
| DR-M10SUC : No. XA019  | DR-M10BEK : No. XA020  | DR-M10SAX : No. YD025   |
| DR-MV1SUC : No. YD006  | DR-MV1SEK : No. YD014  | DR-MH30SAX : No. YD044  |
| DR-MH20SUC : No. YD026 | DR-MV1BEK : No. YD014  | DR-M10STW : No. YD046   |
| DR-MH30SUC : No. YD026 | DR-MH20SEK : No. YD027 | DR-MH30STW : No. YD026  |
| DR-M10SUJ : No. XA019  | DR-MH30SEK : No. YD027 |                         |
| DR-MV1SUJ : No. YD022  | DR-M10SER : No. XA020  |                         |
| DR-MH20SUJ : No. YD026 | DR-MH30SER : No. YD027 |                         |
| DR-MH30SUJ : No. YD026 | DR-M10SEF : No. XA020  |                         |
|                        | DR-MV1SEF : No. YD014  |                         |
|                        | DR-MH20SEF : No. YD027 |                         |
|                        | DR-MH30SEF : No. YD027 |                         |

**ATTACHMENT**

- |  |   |   |
|--|---|---|
| <input type="checkbox"/> NONE              | <input type="checkbox"/> EXPLODED VIEW        | <input type="checkbox"/> ADJUSTMENT PROCEDURE     |
| <input type="checkbox"/> SCHEMATIC DIAGRAM | <input type="checkbox"/> COMPONENT/PWB LAYOUT | <input checked="" type="checkbox"/> SEE NEXT PAGE |

**VICTOR COMPANY OF JAPAN, LIMITED**

AV & MULTIMEDIA COMPANY, GLOBAL QUALITY MANAGEMENT DEPARTMENT,  
 CUSTOMER SATISFACTION CENTER [1.:3.:0.:0.:0]

12, 3-chome, Moriya-cho, Kanagawa-ku, Yokohama, Kanagawa, 221-8528, Japan TEL:+81-45-450-2552 FAX:+81-45-450-2558

**<Symptom>**

After make the power on mode for a while, the green or white noise and sound noise occurs and then become the loading sutiation.



**<Cause>**

The clock of some type of IC1401 (DIGITAL BOARD ASSY) is unstable.

**<Service measure>**

## 1. Countermeasure for DR-M10, DR-MV1

Check the the DIGITAL BOARD ASSY No..

Then select the relevant countermeasure from the below table according to the DIGITAL BOARD ASSY No..

Then do the relevant countermeasure as shown below.

MODELS	DIGITAL BOARD ASSY No.	COUNTERMEASURE IN SERVICE	CARRIED OUT COUNTERMEASURE IN FACTORY	
			FOR VIDEO CLOCK	FOR AUDIO CLOCK
DR-M10SUS	LPA10236-01A, B, C	A	NOT COMPLIED WITH	NOT COMPLIED WITH
DR-M10SUC	LPA10236-01D	B	COMPLIED WITH	NOT COMPLIED WITH
DR-M10SUJ	LPA10236-01E ~	NEED NOT	COMPLIED WITH	COMPLIED WITH
DR-M10BE	LPA10236-03A, B, C	A	NOT COMPLIED WITH	NOT COMPLIED WITH
DR-M10SEU	LPA10236-03D	B	COMPLIED WITH	NOT COMPLIED WITH
DR-M10SEK				
DR-M10BEK	LPA10236-03E	NEED NOT	COMPLIED WITH	COMPLIED WITH
DR-M10SEF				
DR-MV1SUS	LPA10236-05A, B, C, D	A	NOT COMPLIED WITH	NOT COMPLIED WITH
DR-MV1SUC	LPA10236-05E, F	B	COMPLIED WITH	NOT COMPLIED WITH
DR-MV1SUJ				
SR-MV30US	LPA10236-05G ~	NEED NOT	COMPLIED WITH	COMPLIED WITH
DR-MV1SEU	LPA10236-06A, B	A	NOT COMPLIED WITH	NOT COMPLIED WITH
DR-MV1BEU	LPA10236-06C	B	COMPLIED WITH	NOT COMPLIED WITH
DR-MV1SEK				
DR-MV1BEK	LPA10236-06D~	NEED NOT	COMPLIED WITH	COMPLIED WITH
DR-MV1SEF				
DR-M10SAA	LPA10236-07A	A	NOT COMPLIED WITH	NOT COMPLIED WITH
	LPA10236-07B	B	COMPLIED WITH	NOT COMPLIED WITH
	LPA10236-07C ~	NEED NOT	COMPLIED WITH	COMPLIED WITH
DR-M10SAA2	LPA10236-11A	A	NOT COMPLIED WITH	NOT COMPLIED WITH
	LPA10236-11B	B	COMPLIED WITH	NOT COMPLIED WITH
	LPA10236-11C ~	NEED NOT	COMPLIED WITH	COMPLIED WITH
DR-M10SER	LPA10236-08A	A	NOT COMPLIED WITH	NOT COMPLIED WITH
	LPA10236-08B	B	COMPLIED WITH	NOT COMPLIED WITH
	LPA10236-08C ~	NEED NOT	COMPLIED WITH	COMPLIED WITH
DR-M10SAG	LPA10236-10A	A	NOT COMPLIED WITH	NOT COMPLIED WITH
	LPA10236-10B	B	COMPLIED WITH	NOT COMPLIED WITH
	LPA10236-10C ~	NEED NOT	COMPLIED WITH	COMPLIED WITH
DR-M10SAX	LPA10236-12A	A	NOT COMPLIED WITH	NOT COMPLIED WITH
	LPA10236-12B	B	COMPLIED WITH	NOT COMPLIED WITH
	LPA10236-12C ~	NEED NOT	COMPLIED WITH	COMPLIED WITH
DR-M10STW	LPA10236-13A, B, C	A	NOT COMPLIED WITH	NOT COMPLIED WITH
	LPA10236-13D	B	COMPLIED WITH	NOT COMPLIED WITH
	LPA10236-13E ~	NEED NOT	COMPLIED WITH	COMPLIED WITH
DR-MV1SAA	LPA10236-17A	A	NOT COMPLIED WITH	NOT COMPLIED WITH
	LPA10236-17B, C	B	COMPLIED WITH	NOT COMPLIED WITH
	LPA10236-17D ~	NEED NOT	COMPLIED WITH	COMPLIED WITH
DR-MV1SAS	LPA10236-20A	A	NOT COMPLIED WITH	NOT COMPLIED WITH
	LPA10236-20B	B	COMPLIED WITH	NOT COMPLIED WITH
	LPA10236-20C ~	NEED NOT	COMPLIED WITH	COMPLIED WITH
SR-MV50US	LPA10236-21A	A	NOT COMPLIED WITH	NOT COMPLIED WITH
	LPA10236-21B	B	COMPLIED WITH	NOT COMPLIED WITH
	LPA10236-21C ~	NEED NOT	COMPLIED WITH	COMPLIED WITH

A) Add a SUB PWB ASSY (YB20820F1) on the DIGITAL BOARD ASSY as shown below.  
#500SPACER: PU59915-105(100pcs/1sheet)

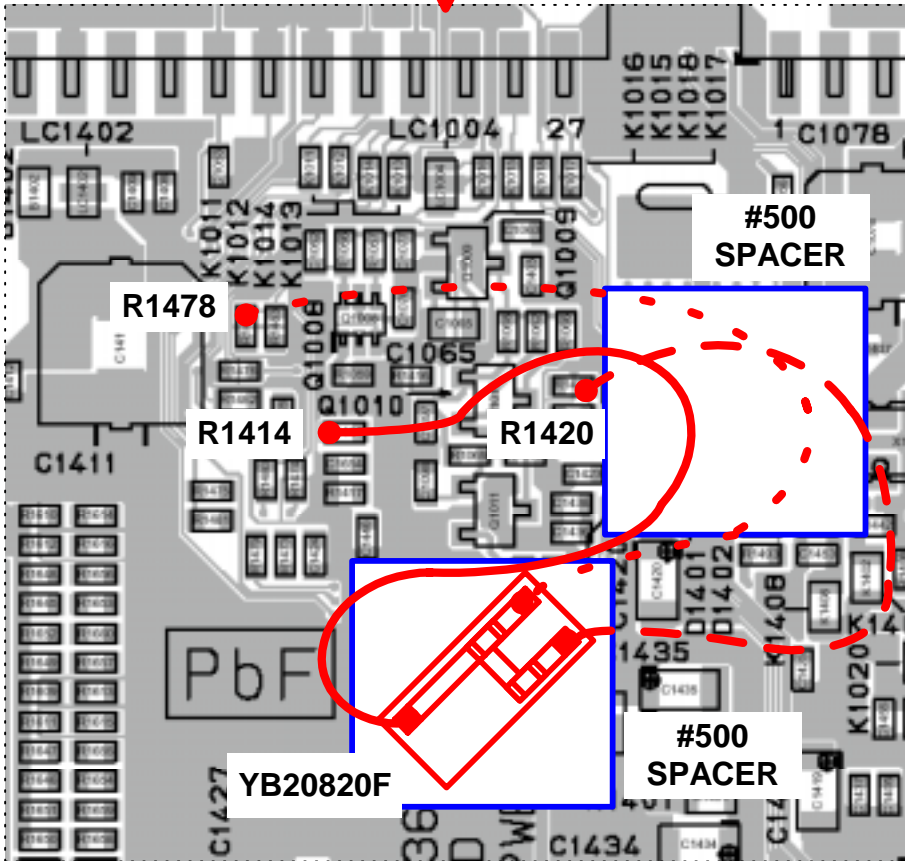
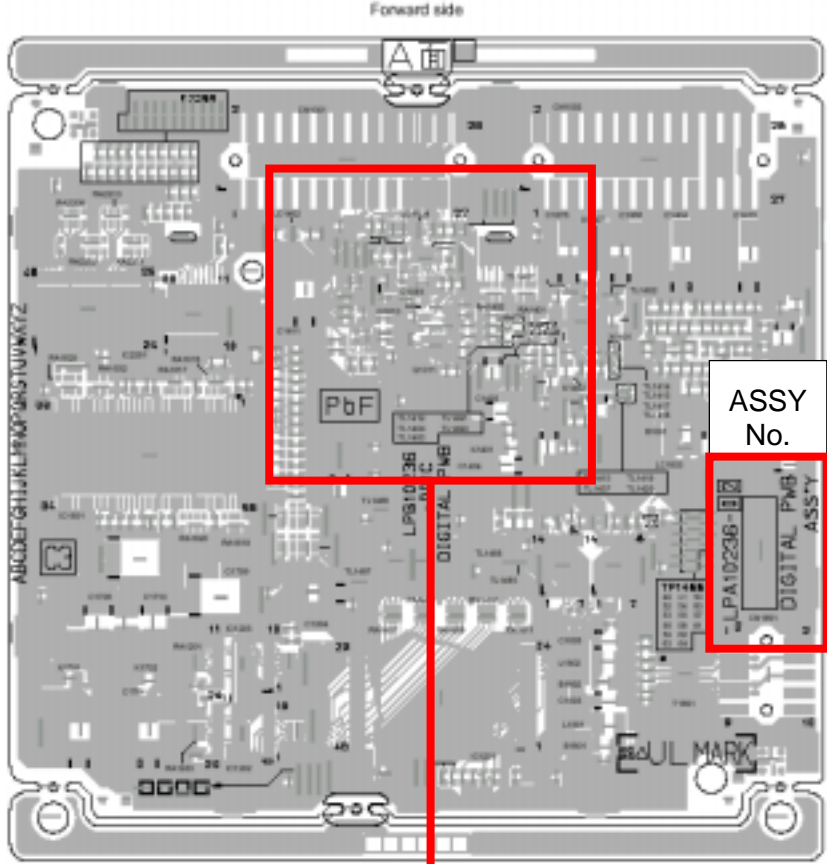

B) Add a SUB PWB ASSY (YB20820F1) on the DIGITAL BOARD ASSY as shown below.  
#500SPACER: PU59915-105(100pcs/1sheet)

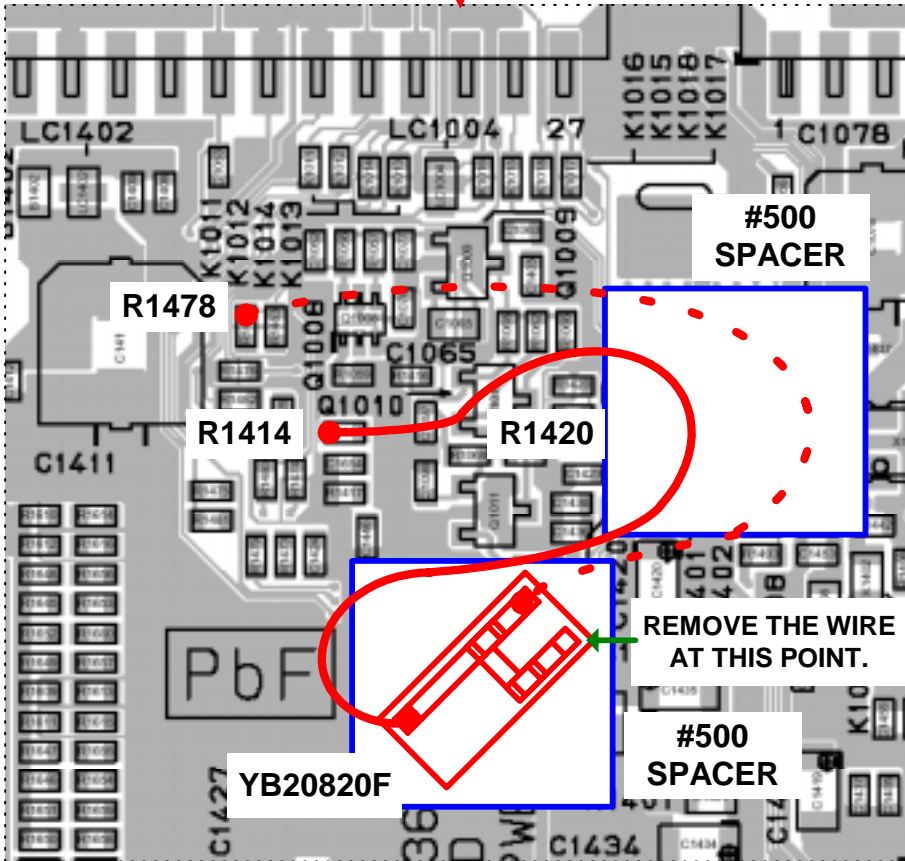
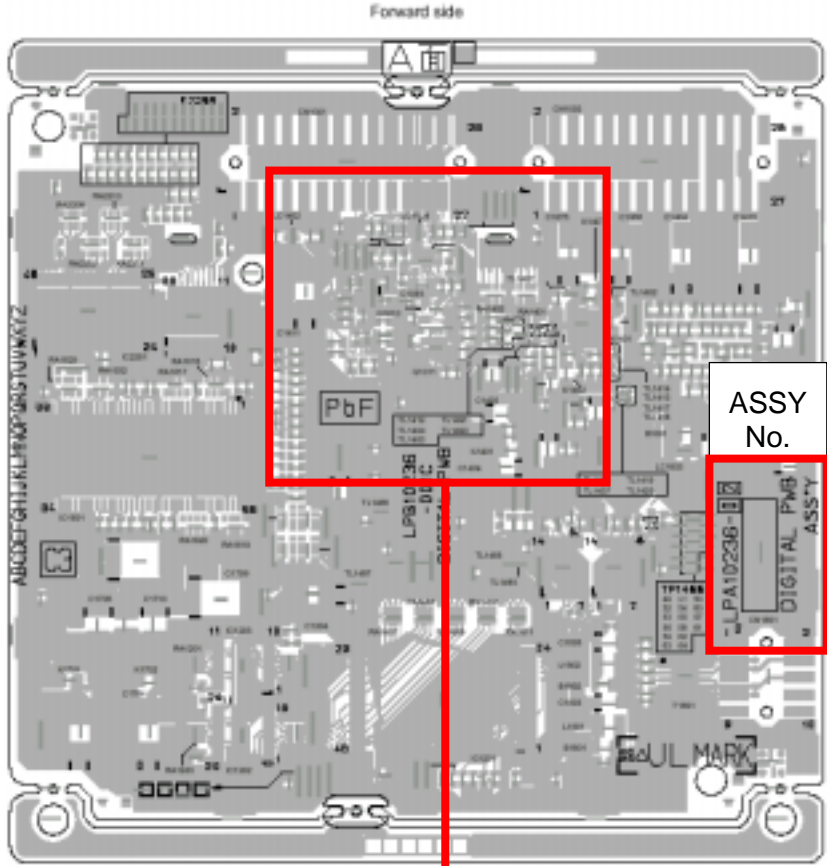



## 2. Countermeasure for DR-MH20, DR-MH30, DR-MX1

Check the the DIGITAL BOARD ASSY No..

Then select the relevant countermeasure from the below table according to the the DIGITAL BOARD ASSY No..

Then do the relevant countermeasure as shown below.

MODELS	DIGITAL BOARD ASSY No.	COUNTERMEASURE IN SERVICE	CARRIED OUT COUNTERMEASURE IN FACTORY	
			FOR VIDEO CLOCK	FOR AUDIO CLOCK
DR-MH20SUS DR-MH30SUS	LPA10247-01A, B, C	A	NOT COMPLIED WITH	NOT COMPLIED WITH
DR-MH20SUC DR-MH30SUC	LPA10247-01D	B	NOT COMPLIED WITH	NOT COMPLIED WITH
DR-MH20SUJ DR-MH30SUJ	LPA10247-01E	C	COMPLIED WITH	NOT COMPLIED WITH
DR-MH30STW	LPA10247-01F ~	NEED NOT	COMPLIED WITH	COMPLIED WITH
DR-MH20SE DR-MH30SE DR-MH20SEK	LPA10247-03A, B, C, D	A	NOT COMPLIED WITH	NOT COMPLIED WITH
DR-MH30SEK DR-MH30SER	LPA10247-03E	B	NOT COMPLIED WITH	NOT COMPLIED WITH
DR-MH20SEF DR-MH30SEF DR-MH30SAA DR-MH30SAG DR-MH30SAX	LPA10247-03F	C	COMPLIED WITH	NOT COMPLIED WITH
	LPA10247-03G ~	NEED NOT	COMPLIED WITH	COMPLIED WITH
DR-MX1SUS	LPA10247-05A, B, C	C	COMPLIED WITH	NOT COMPLIED WITH
	LPA10247-05D ~	NEED NOT	COMPLIED WITH	COMPLIED WITH

A) Add a SUB PWB ASSY (LPA20044-001A) on the DIGITAL BOARD ASSY as shown below.  
#500SPACER: PU59915-105(100pcs/1sheet)

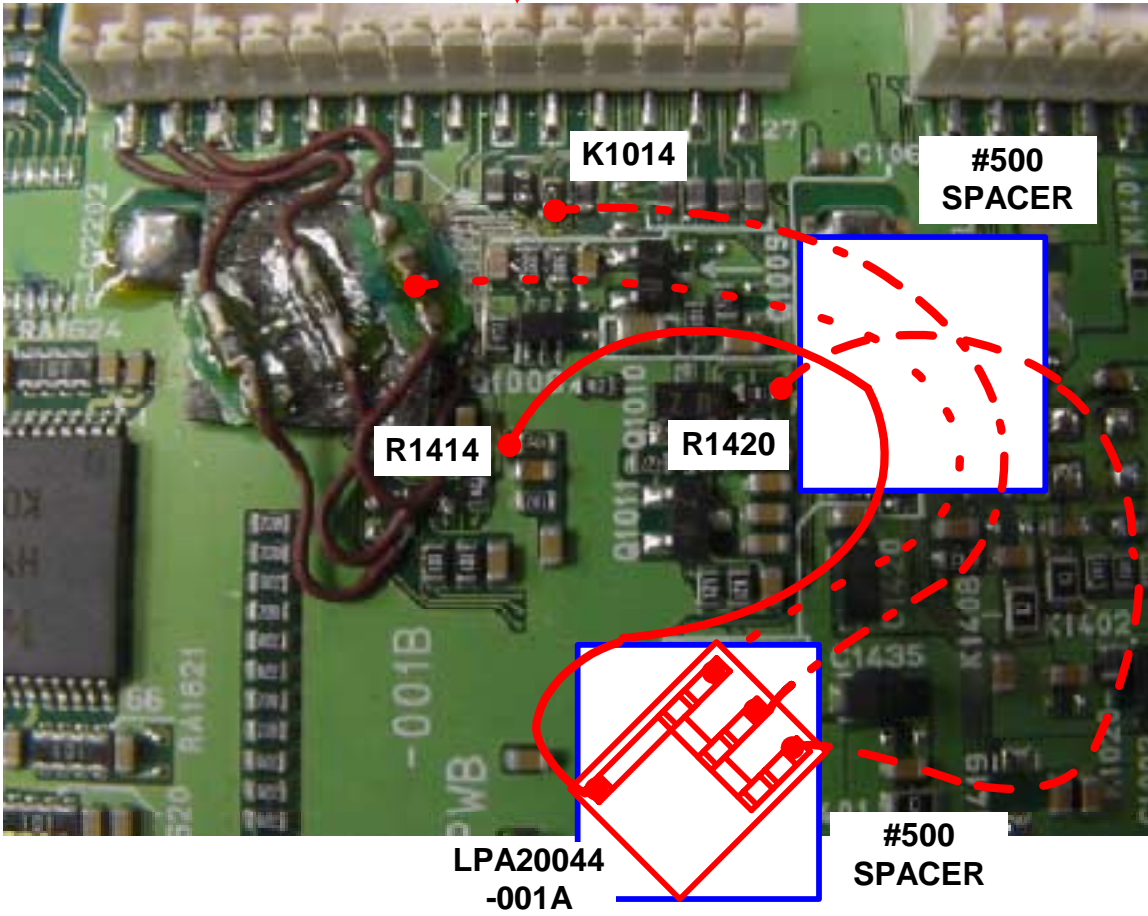
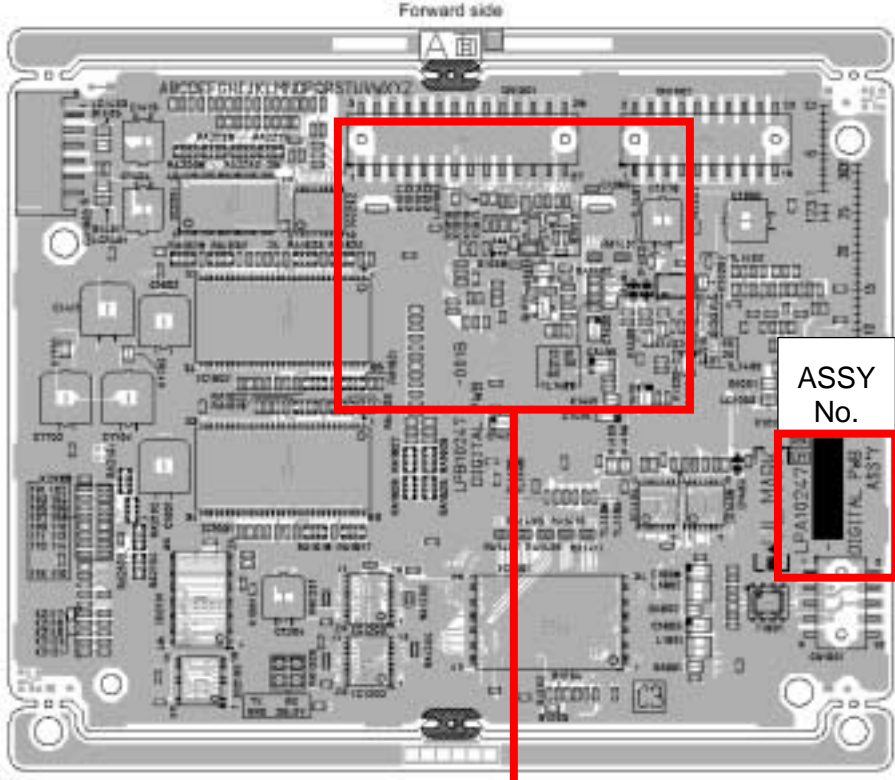

B) Add a SUB PWB ASSY (LPA20044-001A) on the DIGITAL BOARD ASSY as shown below.  
#500SPACER: PU59915-105(100pcs/1sheet)

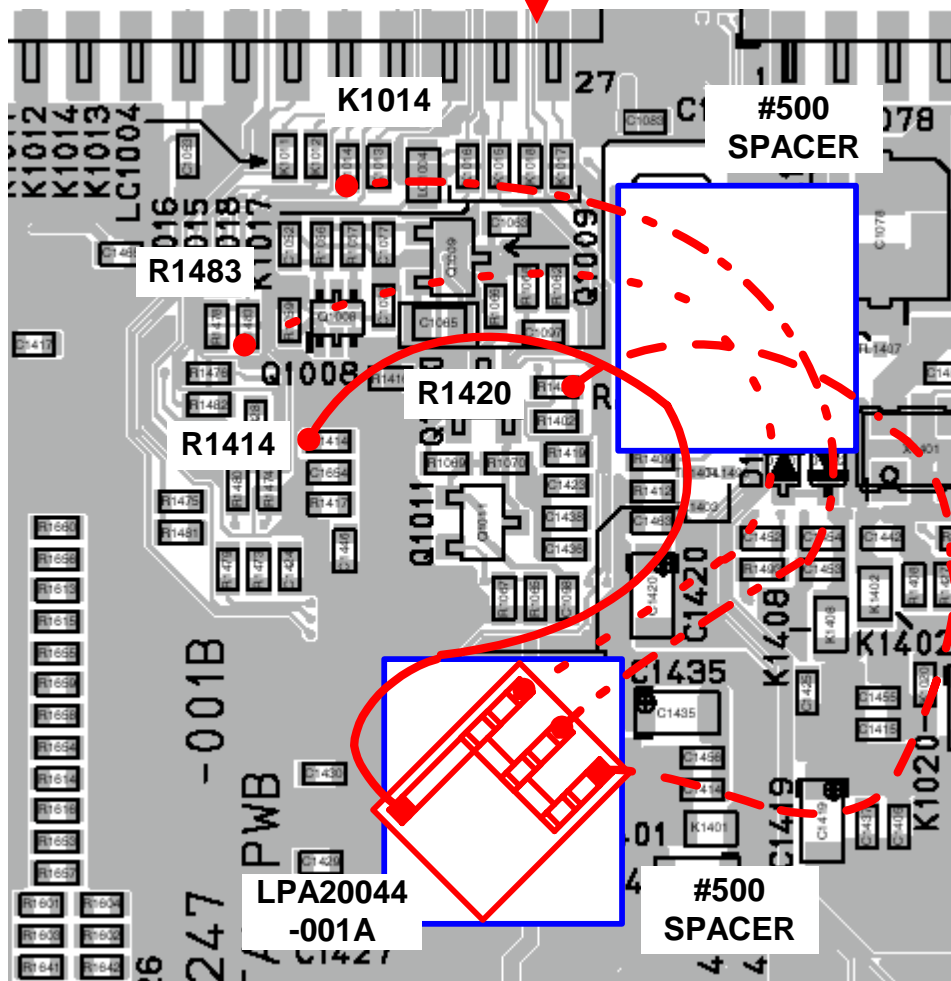
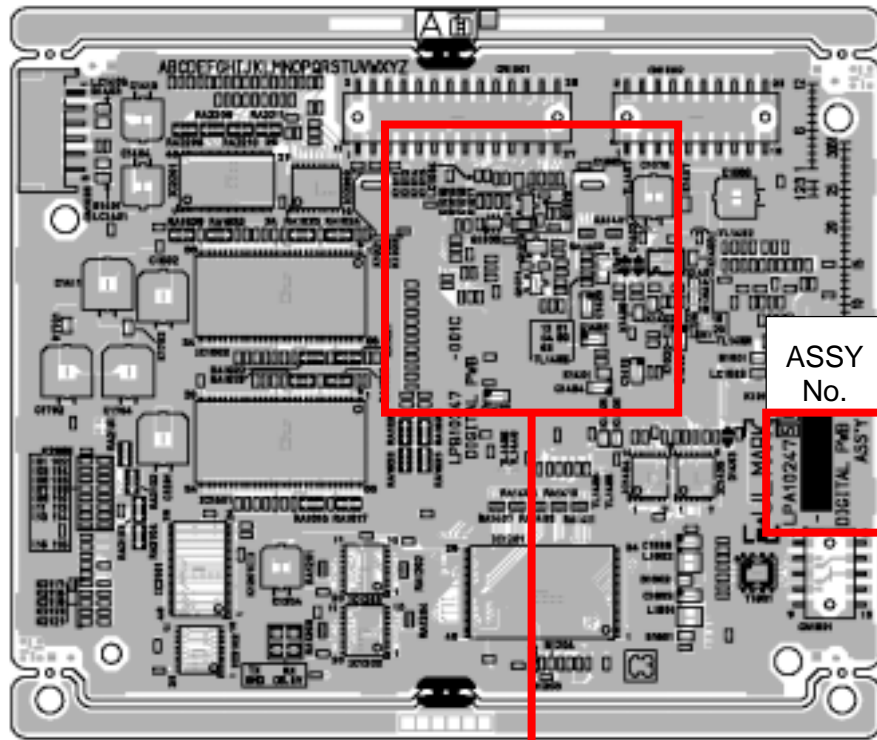

- C) Add a SUB PWB ASSY (LPA20044-001A) on the DIGITAL BOARD ASSY as shown below.  
 #500SPACER: PU59915-105(100pcs/1sheet)

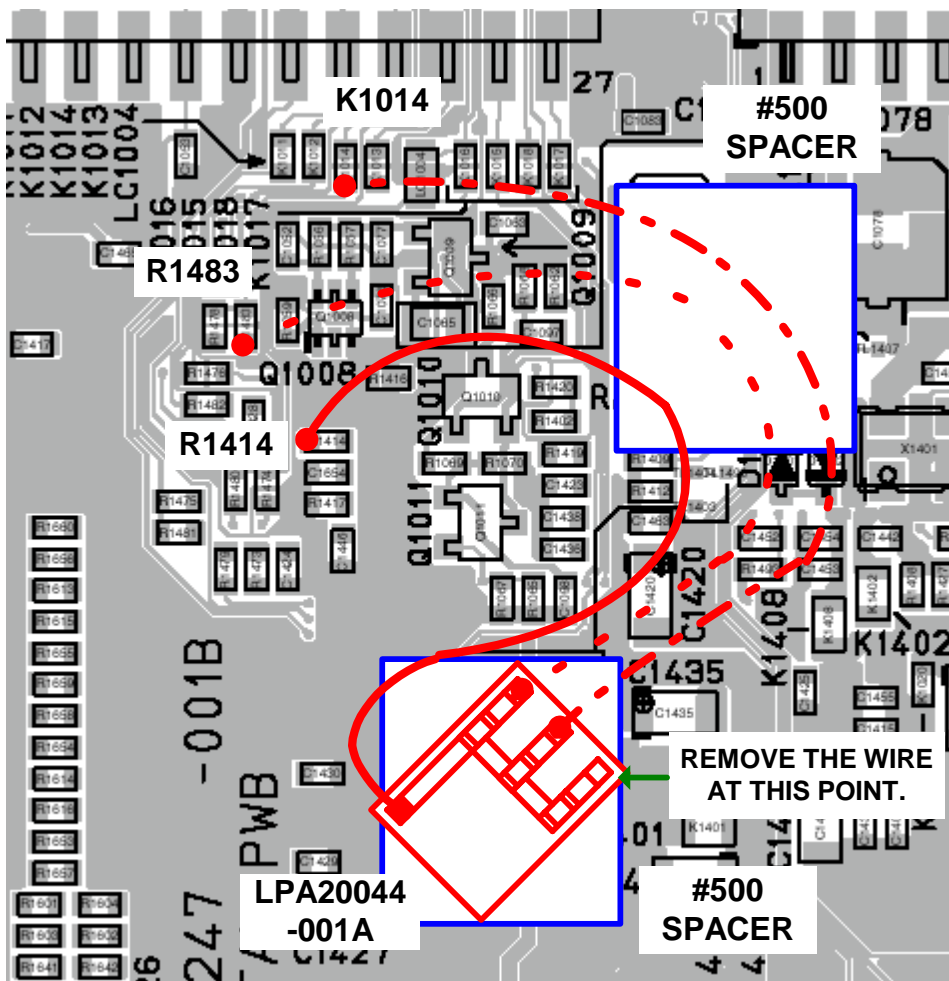
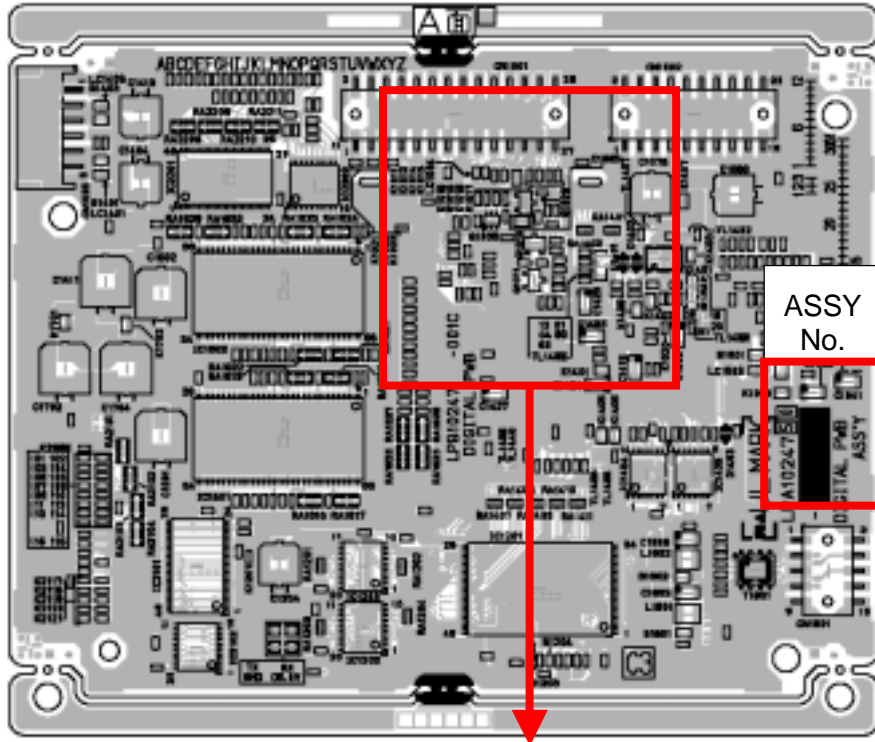

# JVC Service Bulletin

**SUBJECT:** COUNTERMEASURE FOR DRY UP OF E CAP

**DATE:** MAY, 2005

<b>Model &amp; Manual No.</b> Shown below	<b>Performed at factory</b>	<b>Priority</b> <input type="checkbox"/> S. All Products. <input type="checkbox"/> A. Items in JVC/Dealer stock/Service return goods. <input type="checkbox"/> B. JVC stock/Units returned for service. <input checked="" type="checkbox"/> C. Sold items returned for service. <input type="checkbox"/> D. Only Units related to this bulletin. <input type="checkbox"/> E. Others.
<b>Reference Information</b>		

**<Models>**

- |                       |                       |
|-----------------------|-----------------------|
| DR-MV1SUS : No. YD006 | DR-MV1SEU : No. YD014 |
| DR-MV1SUC : No. YD006 | DR-MV1BEU : No. YD014 |
| DR-MV1SUJ : No. YD022 | DR-MV1SEK : No. YD014 |
| SR-MV30US : No. YD012 | DR-MV1BEK : No. YD014 |
| DR-MV1SAA : No. YD036 | DR-MV1SEF : No. YD014 |
| DR-MV1SAS : No. YD036 |                       |

**<Symptom>**

The unit becomes the loading situation.

**<Cause>**

In REGULATOR ASSEMBLY, C5205, C5206 and C5207 is heated by D5205 and D5208, then C5205, C5206 and C5207 dry up.

**ATTACHMENT**

- |  |   |   |
|--|---|---|
| <input type="checkbox"/> NONE              | <input type="checkbox"/> EXPLODED VIEW        | <input type="checkbox"/> ADJUSTMENT PROCEDURE     |
| <input type="checkbox"/> SCHEMATIC DIAGRAM | <input type="checkbox"/> COMPONENT/PWB LAYOUT | <input checked="" type="checkbox"/> SEE NEXT PAGE |

**VICTOR COMPANY OF JAPAN, LIMITED**

AV & MULTIMEDIA COMPANY, GLOBAL QUALITY MANAGEMENT DEPARTMENT,  
CUSTOMER SATISFACTION CENTER [1.:3.:0.:0.:0]

12, 3-chome, Moriya-cho, Kanagawa-ku, Yokohama, Kanagawa, 221-8528, Japan TEL:+81-45-450-2552 FAX:+81-45-450-2558

<Service measure>

1. Displacement of D5205 and D5208

Mobilize D5205 and D5208 from COMPONENT SIDE to FOIL SIDE as shown below.

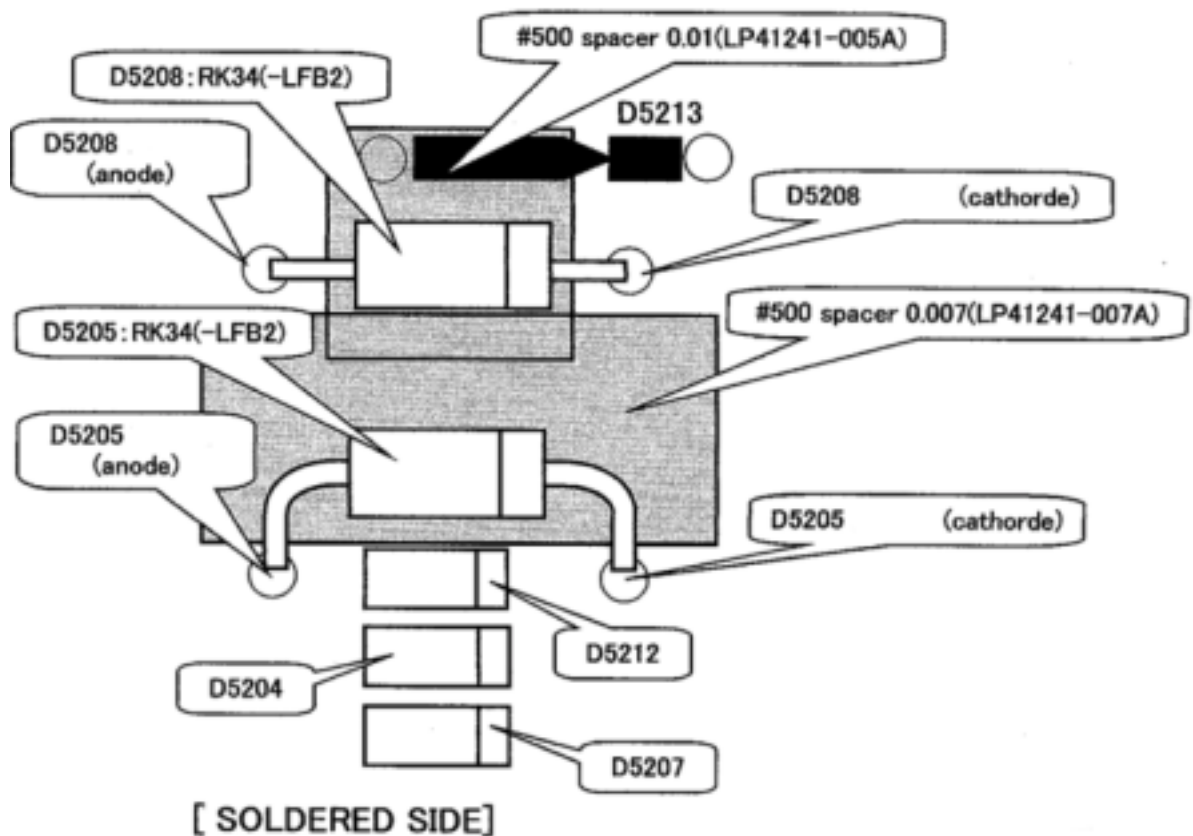
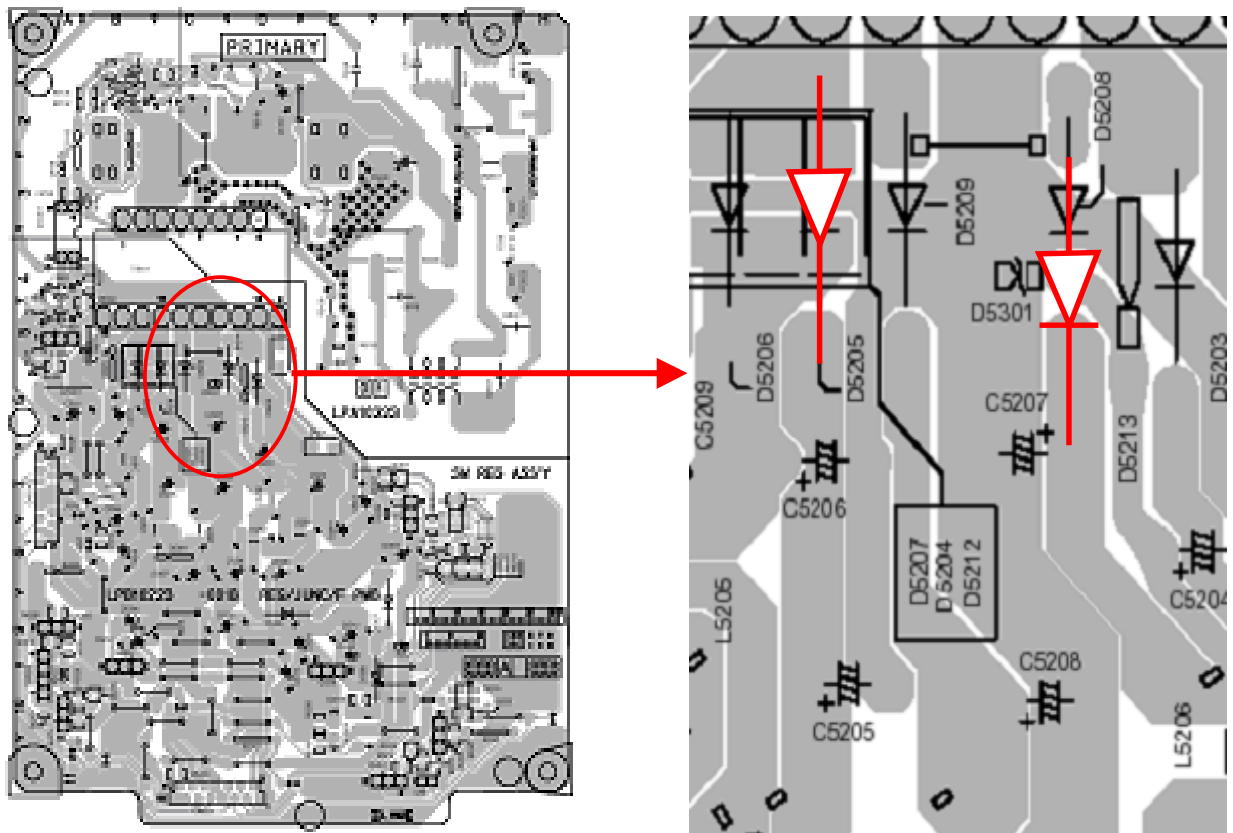

2. Change of C5205, C5206 and C5207  
Change C5205, C5206 and C5207 as shown below.

Page	Ref. No.	Previous Part No.	New Part No.	Part Name	FOB (New Part)	Itg	Rsn	Note
3-6	C5205	QEMT1AM-128	QECS1AM-158 or QECP1AM-158 or QTM91AM-158	E CAPACITOR	-	C	B	-
3-6	C5206	QECS1AM-128	QECS1AM-158 or QECP1AM-158 or QTM91AM-158	E CAPACITOR	-	C	B	-
3-7	C5207	QECS0JM-158	QECS0JM-478 or QECP0JM-478 or QTM90JM-478	E CAPACITOR	-	C	B	-
		DR-MV1SUS :	No. YD006					
		DR-MV1SUC :	No. YD006					
		SR-MV30US :	No. YD012					
3-8	C5205	QEMT1AM-128	QECS1AM-158 or QECP1AM-158 or QTM91AM-158	E CAPACITOR	-	C	B	-
3-8	C5206	QECS1AM-128	QECS1AM-158 or QECP1AM-158 or QTM91AM-158	E CAPACITOR	-	C	B	-
3-8	C5207	QECS0JM-158	QECS0JM-478 or QECP0JM-478 or QTM90JM-478	E CAPACITOR	-	C	B	-
		DR-MV1SUJ :	No. YD022					
		DR-MV1SAA :	No. YD036					
		DR-MV1SAS :	No. YD036					

Page	Ref. No.	Previous Part No.	New Part No.	Part Name	FOB (New Part)	Itg	Rsn	Note
3-9	C5205	QEMT1AM-128	QECS1AM-158 or QECP1AM-158 or QTM91AM-158	E CAPACITOR		C	B	-
3-9	C5206	QECS1AM-128	QECS1AM-158 or QECP1AM-158 or QTM91AM-158	E CAPACITOR	-	C	B	-
3-9	C5207	QECS0JM-158	QECS0JM-478 or QECP0JM-478 or QTM90JM-478	E CAPACITOR	-	C	B	-
		DR-MV1SEU : DR-MV1BEU : DR-MV1SEK : DR-MV1BEK : DR-MV1SEF :	No. YD014 No. YD014 No. YD014 No. YD014 No. YD014					

**Itg: INTERCHANGEABILITY**

- |   |                         |
|---|-------------------------|
| A. Completely interchangeable.  | D. Not interchangeable. |
| B. Previous part can be used for new set, but new part cannot be used for previous set. | E. Addition.            |
| C. New part can be used for previous set, but previous part cannot be used for new set. | F. Deletion.            |

**Rsn: REASON FOR CHANGE**

- |                            |                            |
|----------------------------|----------------------------|
| A. To improve performance  | E. Standardization of part |
| B. To improve reliability  | F. For your demand         |
| C. To improve safety       | G. Correction of misprint  |
| D. To improve productivity | H. Others                  |

**<Product>**

Above counter measure had been enforced from MAY 2005.